

**CGN**  
LE SENS DU DÉTAIL



ÉDITION N°9 **PIÈCES DÉTACHÉES  
MOTORISÉES**

Cher client,

Toute l'équipe CGN est fière de vous présenter la 9ème édition de notre catalogue. En cette année particulière, c'est avec une immense joie que **nous célébrons nos 30 ans**. Trente ans de passion, de partage et d'échange, à vos côtés.

Afin de répondre au mieux à vos besoins et ceux de vos clients, vous découvrirez dans ce nouveau catalogue davantage de références et d'informations techniques.

Nos engagements restent inchangés, et nous continuerons de mettre un point d'honneur à mettre tout en œuvre pour vous offrir un service optimum.

Nous vous souhaitons une agréable lecture,

L'équipe CGN



**Fabrice CHALLET**  
Directeur administratif et financier



**Joël GARAUD**  
Directeur commercial





## QUI SOMMES NOUS ?

C'est en 1988 que M. Michel CHALLET donna naissance à CGN. Déjà propriétaire d'une concession de cycles et cyclomoteurs au centre ville de Nantes, M. CHALLET souhaitait élargir sa clientèle en passant du particulier aux professionnels.

Depuis sa création, l'entreprise a subi plusieurs phases d'agrandissement relatif à l'élargissement de son activité.

En 30 ans, la CGN est passée d'un local de 150 m<sup>2</sup> pour 500 références proposées à aujourd'hui 10 000 m<sup>2</sup> pour plus de 20 000 références en stock permanent d'une valeur de 6 000 000 €.

Avec ses 2 salariés à ses débuts, aujourd'hui la CGN emploie plus de 70 personnes afin de proposer un service de qualité à ses 6000 clients.

La CGN reste aujourd'hui une entreprise familiale qui commercialise des pièces détachées et accessoires pour scooters et motos ainsi que des équipements pour les pilotes.

Notre entreprise distribue également des pièces détachées et accessoires pour les vélos ainsi que des équipements pour les cyclistes.

### VOS INFOS PERSO

Votre code client : .....

Votre commercial : .....

Prénom : .....

Nom : .....

Tél : .....

### NOS COORDONNÉES



[www.cgnfrance.com](http://www.cgnfrance.com)



167, boulevard Salvador Allende  
44812 Saint Herblain Cedex - France



[contact@cgnfrance.com](mailto:contact@cgnfrance.com)



02 40 92 00 95



France : 02 40 92 04 88  
Export : 00 33 (0)2 40 92 17 65



CGN

NOS ÉQUIPES S'ENGAGENT À TOUT METTRE EN ŒUVRE POUR UNE LIVRAISON SOUS 24h EN FRANCE MÉTROPOLITAINE.



# UNE ÉQUIPE À VOS CÔTÉS !

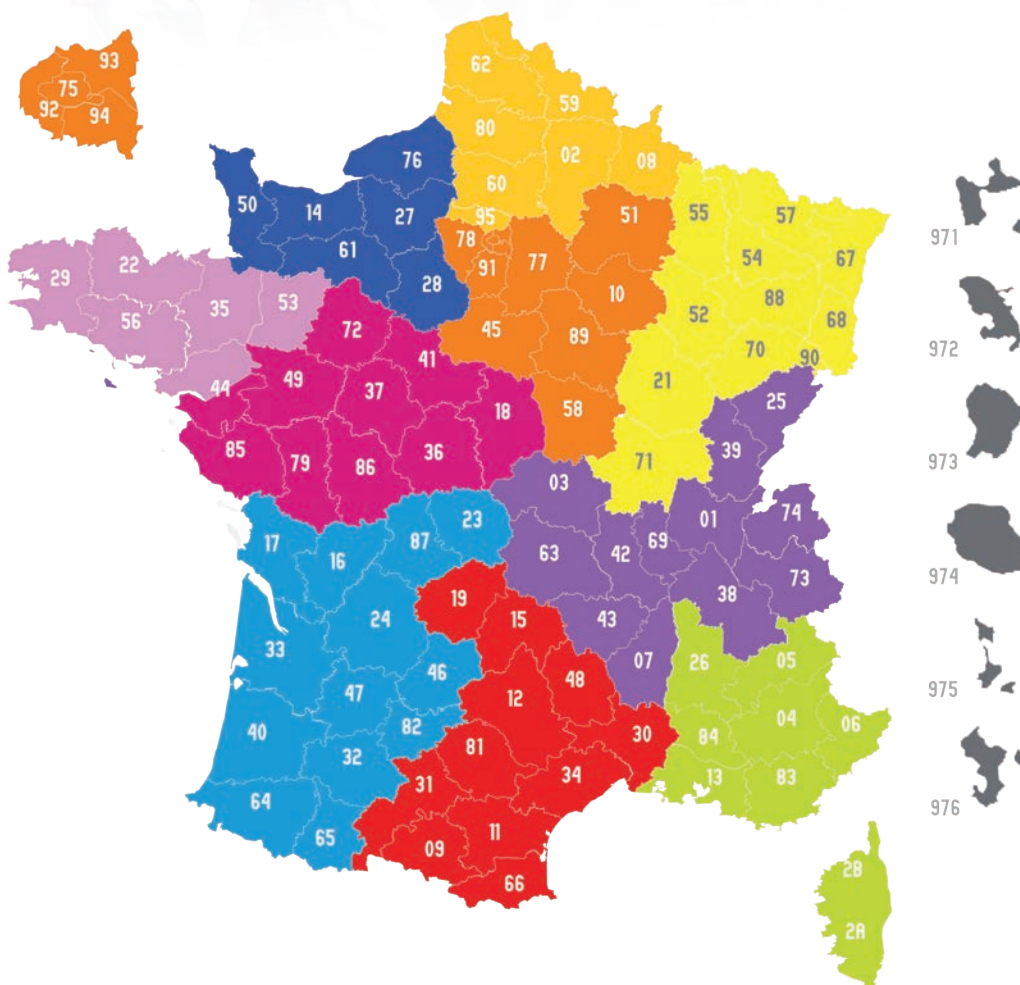

## DOM TOM

**Guy POISSON**

**06 74 57 07 72**

[guy.poisson@cgfrance.com](mailto:guy.poisson@cgfrance.com)

**Mireille POISSON**

**06 20 68 13 21**

[mireille.poisson@cgfrance.com](mailto:mireille.poisson@cgfrance.com)

**Sébastien GASSON**

**06 16 09 54 58**

[sebastien.gasson@cgfrance.com](mailto:sebastien.gasson@cgfrance.com)



## NORMANDIE

Guillaume VERNIER  
06 80 43 46 49  
guillaume.vernier@cgfrance.com

En remplacement de Philippe Cousseau

## NORD PAS-DE-CALAIS

Vincent JANVIER  
06 31 16 91 13  
vincent.janvier@cgfrance.com



## BRETAGNE

Philippe LE GALLOUDEC  
06 72 22 05 13  
philippe.legalloudec@cgfrance.com

## ILE DE FRANCE

Philippe PELLETIER  
06 31 54 08 49  
philippe.pelletier@cgfrance.com



## PAYS DE LOIRE

Sébastien MILLET  
06 08 31 06 01  
sebastien.millet@cgfrance.com

## EST

Franck BERTHOLD  
06 87 95 48 48  
franck.berthold@cgfrance.com



## AQUITAINE

Laurent ALBERGUCCI  
06 73 09 41 94  
laurent.albergucci@cgfrance.com

## RHONE ALPES

Bernard DONZEL  
06 73 10 16 01  
bernard.donzel@cgfrance.com



## MIDI-PYRÉNÉES

Patrick GRAS  
06 07 33 42 14  
patrick.gras@cgfrance.com

## EXPORT



Simon GIBBS  
+33 240 922 096  
simon.gibbs@cgfrance.com



# À VOTRE DISPOSITION POUR VOUS RENSEIGNER



## VOS TÉLÉCONSEILLERS



**Anthony**  
02 40 92 33 11



**Juan**  
02 40 92 33 09



**Bruno**  
02 40 92 33 08



**Daniel**  
02 40 92 33 10



**Pascal**  
02 40 92 33 07



**Nicolas (DOM TOM)**  
02 40 92 21 33



## VOS CONTACTS



**Carole**  
**Standard**  
02 40 92 00 95



**Annabelle**  
**Ouverture de compte**  
02 40 92 21 36  
annabelle.freour-fourage@cgfrance.com



**Gaëtan**  
**Assistance Win CGN**  
02 40 92 00 95  
gaetan.borleteau@cgfrance.com



**Brigitte**  
**Comptabilité client**  
02 72 00 55 01  
brigitte.michel@cgfrance.com



**Béatrice**  
**Suivi transport**  
02 40 92 20 98  
service.transports@cgfrance.com



**Pascal**  
**SAV**  
02 40 92 33 00  
garantiesav@cgfrance.com



**Christophe**  
**Retour client**  
02 40 92 33 06  
christophe.chapron@cgfrance.com



# INDEX FRANÇAIS

## A

Acide de batterie ..... 36  
Adaptateur filtre à air ..... 56  
Adaptateur pour commande de compteur ..... 363  
Adaptateur rétroviseur ..... 429  
Aide au démarrage ..... 36  
Aimant de compteur ..... 363  
Alarme ..... 388,575  
Alesoir ..... 645  
Allumage ..... 16-32 ; 677-682  
Amortisseur ..... 447-451 ; 706-707  
Ampoule ..... 354-357  
Anti-crevaion ..... 625  
Antiparasite ..... 41-43  
Antivol ..... 574-576  
Arbre à came ..... 693  
Arbre sélecteur ..... 239  
Arrache roulement ..... 641  
Arrache variateur ..... 211  
Arrache volant ..... 639-640  
Attache-rapide ..... 259-262  
Autocollant ..... 265-272  
Avertisseur ..... 405  
Axe de pédalier ..... 438  
Axe masselotte ..... 211-207  
Axe moteur ..... 92  
Axe pour béquille ..... 674  
Axe sélecteur ..... 239

## B

Bague d'échappement ..... 185  
Bague de colonnette ..... 211  
Bague de joue mobile ..... 211  
Bague de pédalier ..... 438  
Bague de roulement ..... 213  
Balance de précision ..... 642  
Bande plaque d'immatriculation ..... 659-667  
Barillet ..... 403  
Barillet sélection vitesse ..... 403  
Bas de caisse ..... 277-304  
Batterie ..... 32-36  
Béquille véhicule ..... 430-434 ; 709  
Bielle d'embrayage ..... 221  
Bielle support moteur ..... 92  
Bille d'embrayage ..... 213  
Bille de variateur ..... 213  
Bloc CDI ..... 28 ; 677  
Blouson ..... 578  
Bobine ..... 18,25  
Bobine CDI/haute tension ..... 28-29 ; 678  
Bobine haute tension ..... 17,27 ; 677  
Bobine papier ..... 636  
Bocal maître cylindre ..... 533  
Boisseau carburateur ..... 58-63 ; 687  
Boîte à clapet ..... 80-81  
Boîte à outils ..... 675  
Boîte de vitesse ..... 238  
Boîtier calculateur ..... 19,23  
Boîtier multicourbe ..... 24  
Bombe anti-crevaion ..... 625  
Bombe de peinture ..... 273-275  
Bouchon d'essence ..... 385-387 ; 705  
Bouchon d'huile ..... 238-239  
Bouchon de mise à l'air libre ..... 315,386  
Bouchon de vidange ..... 140  
Bouchon décompresseur ..... 139  
Bougie ..... 37-43  
Boulon 6 pans ..... 652  
Bouton pousoir ..... 406  
Bride capot volant ..... 670  
Brosse à bougie ..... 638  
Buffer ..... 625  
Bulle optique ..... 325  
Butée de gaine ..... 653

## C

Câble de compteur ..... 369-371 ; 712  
Câble de décompresseur ..... 528  
Câble de frein ..... 524,526 ; 713  
Câble de gaz ..... 525-528 ; 713  
Câble starter ..... 526  
Câble universel ..... 527  
Cabochon de clignotant ..... 331-335 ; 711  
Cabochon de feu arrière ..... 344-350  
Cache cylindre et classe ..... 159  
Cache pignon ..... 314  
Cache rivet ..... 658  
Cache turbine ..... 159-160,306  
Cache-volant ..... 30  
Cage à aiguille ..... 127-135  
Cagoule ..... 580  
Calculateur digimax ..... 19,23  
Cale-pieds ..... 435  
Calorstat ..... 158  
Caméra embarquée ..... 366  
Capot de filtre à air ..... 670  
Capot de maître cylindre ..... 533  
Capot de selle ..... 291-292  
Capotage compteur ..... 277-305  
Capotage latéral ..... 293-294  
Capteur CDI ..... 20,25  
Capteur de vitesse ..... 363  
Capuchon de contacteur à clé ..... 385  
Capuchon de valve ..... 568-570  
Carburateur ..... 58-62 ; 687  
Carrosserie ..... 276-320  
Carter ..... 88  
Carter d'allumage ..... 315  
Carter de kick/variateur ..... 209  
Carter de transmission ..... 237  
Centrale de clignotant ..... 31,332-340  
Chaîne ..... 259-263  
Chaîne de distribution ..... 137  
Chambre à air ..... 565-567  
Chargeur allume cigare ..... 366  
Chargeur de batterie ..... 35  
Chasse joint ..... 649  
Circlip axe de kick ..... 442  
Clapet ..... 80-87 ; 687  
Clapet anti-retour ..... 638  
Clapet carter moteur ..... 80-87 ; 687  
Clavette allumage ..... 29-30  
Clavette pignon ..... 239  
Clé à bougie ..... 638  
Clé à rayon ..... 637  
Clé de sangle ..... 640  
Clignotant ..... 328-340  
Clip ..... 127  
Clip d'embrayage ..... 222  
Clip de pédalier ..... 438  
Cloche d'embrayage ..... 215-222 ; 702  
Code de vitesse ..... 536  
Coffret de douille ..... 650  
Colle ..... 630-631  
Collier ..... 429  
Collier de filtre à air ..... 50  
Collier de silencieux ..... 173-190  
Collier durite d'essence ..... 74  
Collier durite de refroidissement ..... 164  
Collier rilsan ..... 631  
Colonnette ..... 211  
Combinaison de pluie ..... 577  
Commodo ..... 404-406 ; 716  
Comprime ressort amortisseur ..... 637  
Compte-tours ..... 365  
Compteur ..... 362-364  
Condensateur ..... 25 ; 682  
Connecteur ..... 648  
Console auto-radio ..... 284  
Contacteur à clé ..... 381-384 ; 713-714  
Contacteur avertisseur ..... 405

Contacteur de stop ..... 358,406  
Contacteur interrupteur ..... 357-358,406  
Contacteur témoin ..... 357  
Contrepoids ..... 207,211,213  
Coque arrière ..... 276-312  
Coque moteur ..... 291  
Correcteur de couple ..... 217 ; 699  
Cosse ..... 647-648  
Coude carburateur ..... 64  
Coude guide câble ..... 60,69  
Coupe-circuit ..... 388  
Couronne ..... 251-258  
Couronne démarreur ..... 208 ; 682  
Courroie ..... 223-233 ; 703-705  
Courroie pompe à eau ..... 164  
Courroie pompe à huile ..... 161  
Couvercle maître cylindre ..... 533  
Crayon à pneu ..... 275  
Culasse ..... 136-139 ; 693  
Cuve ..... 69  
Cylindre ..... 103-121

## D

Déco ..... 273-275  
Décompresseur ..... 653-654  
Démarreur ..... 31 ; 678  
Demi-collier ..... 190,429  
Démontage demi carter moteur ..... 641  
Démonte embrayage ..... 641  
Démonte filtre à huile ..... 643  
Démonte obus de valve ..... 626  
Démonte pneu ..... 626  
Démonte soupape ..... 643  
Démonte/remonte ressort ..... 649  
Démultiplicateur de compteur ..... 367-368  
Dérive chaîne ..... 644  
Dessous de tablier avant ..... 293  
Dessus de tablier avant ..... 293  
Déteur de fuite ..... 625  
Diagramme ..... 16-24  
Dimensions et grammages  
des galets d'origine ..... 192-193  
Disque d'embrayage ..... 219-222 ; 702  
Disque de frein ..... 458-471  
Disque de meuleuse ..... 650  
Doseur huile ..... 623  
Dossieret ..... 291-292,303  
Dossieret pour passager ..... 592  
Dossieret pour top-case ..... 592  
Double écran anti-buée ..... 582  
Double optique ..... 324-326  
Douille ..... 235,361,642  
Durite eau ..... 159,162,164  
Durite essence ..... 73-74  
Durite pompe à huile ..... 164

## E

Écarteur de plaquette de frein ..... 638  
Écarteur de pneu ..... 626  
Échappement ..... 166-191 ; 695-696  
Éclairage ..... 323-361 ; 711  
Éclairage de plaque ..... 327  
Écoper ..... 297-303  
Écran de lunettes/masque ..... 581-582  
Écrou 6 pans ..... 652  
Écrou auto cassant ..... 385  
Écrou carré ..... 190  
Écrou d'allumage ..... 29  
Écrou d'axe moteur ..... 92  
Écrou d'embrayage ..... 208,213  
Écrou de flasque ..... 211  
Écrou de joue fixe ..... 211,213  
Écrou de tambour embrayage ..... 208,213  
Écrou de variateur ..... 29,207,211  
Écrou rotor/variateur/embrayage ..... 208  
Efficace rayure ..... 635  
Embiellage ..... 93-95 ; 688-689

Embout de câble compteur ..... 371  
Embout de gaine ..... 653  
Embout de gonflage ..... 627  
Embout de guidon ..... 380  
Embrayage ..... 214-222 ; 701-702  
Engrenage ..... 236-239  
Enrouleur ..... 649  
Ensemble deux pièces veste et pantalon ..... 579  
Entonnoir ..... 649  
Entretoise étrier de frein ..... 452  
Épingle de support ..... 50  
Epoxy ..... 631  
Équipement véhicule ..... 583-590  
Équivalence/dimension pneus ..... 535  
Étoile joue fixe ..... 208-209  
Étrier de frein hydraulique ..... 530

## F

Face avant ..... 279-316  
Feu ..... 323-352 ; 711  
Feuille carbone ..... 83  
Feuille de fibre ..... 156  
Fil bougie ..... 670  
Fil électrique ..... 647  
Filon de filetage ..... 642  
Filtre à air ..... 44-45 ; 683-684  
Filtre à huile ..... 685-687  
Filtre essence ..... 74-75  
Fixation pour protège-main ..... 377  
Fixation pour tête de fourche ..... 452  
Fixation roulement ..... 631  
Flasque ..... 208  
Flasque frein arrière ..... 533  
Flexibloc ..... 673  
Flexibloc bas moteur ..... 92  
Flexibloc haut moteur ..... 92  
Fond de jante ..... 571-572  
Fontaine biologique ..... 636  
Fourche ..... 452 ; 709  
Frein filet ..... 630-631  
Freinage ..... 674  
Fusible ..... 646

## G

Gaine ..... 529  
Galet ..... 194-199  
Gant de travail ..... 636  
Garde-boue ..... 277-319  
Gicleur ..... 645  
Gilet de sécurité ..... 579  
Goujon ..... 178  
Graisser ..... 620  
Graisser de câble ..... 623  
Grille de coque arrière ..... 277-278  
Grille de fourche ..... 319  
Grille de protection déco ..... 320  
Grille de variateur ..... 372-380  
Guidon ..... 372-380

## H

Housse de protection ..... 589-590  
Housse de selle ..... 321-322  
Huile ..... 598-615

## I

Immatriculation ..... 658-667  
Imprimante plaque d'immatriculation ..... 658,664

## J

Jauge de filetage ..... 642  
Jerrican ..... 649  
Jeu de direction ..... 454-457 ; 707-708  
Joint ..... 140-156 ; 690-691  
Joint carburateur ..... 69  
Joint carter ..... 90,92  
Joint carter allumage ..... 89-90  
Joint carter embrayage ..... 89  
Joint carter embrayage ..... 149-150  
Joint carter kick/variateur ..... 144  
Joint carter moteur ..... 144,150



# INDEX FRANÇAIS

|                            |                  |
|----------------------------|------------------|
| Joint carter transmission  | 144              |
| Joint clapet               | 145, 150         |
| Joint corps pompe à eau    | 151              |
| Joint culasse              | 144, 149, 151    |
| Joint cylindre             | 103-121          |
| Joint cylindre/embase      | 143, 145, 149    |
| Joint échappement          | 145, 155         |
| Joint étanchéité           | 156              |
| Joint étrier de frein      | 531              |
| Joint haut moteur          | 141-143, 147-149 |
| Joint maître cylindre      | 531              |
| Joint moteur               | 140, 151         |
| Joint pipe d'admission     | 77, 146          |
| Joint plat                 | 156              |
| Joint pompe à eau          | 151              |
| Joint pot échappement      | 145              |
| Joint silencieux           | 152              |
| Joint SPI embiellage/vilo  | 146, 153         |
| Joint SPI fourche          | 455-456 ; 708    |
| Joint SPI moteur           | 140, 152         |
| Joint tendeur de chaîne    | 143              |
| Joint tendeur distribution | 137              |
| Jonction de coque arrière  | 286-288          |
| Joue fixe                  | 203-204          |
| Joue mobile                | 211, 213         |

|                                |               |
|--------------------------------|---------------|
| <b>K</b>                       |               |
| Kick de démarrage              | 439-444       |
| Kit carrosserie                | 276-312 ; 710 |
| Kit chaîne                     | 240-248       |
| Kit entretien                  | 618           |
| Kit purgeur                    | 638           |
| Kit réparation                 | 69-70         |
| Kit réparation maître cylindre | 533           |
| Klaxon                         | 405           |

|                            |                   |
|----------------------------|-------------------|
| <b>L</b>                   |                   |
| Laine silencieux           | 191               |
| Lamelle de clapet          | 82                |
| Lamineuse                  | 658               |
| Lampe                      | 354-357           |
| Lapidaire                  | 650               |
| Lettre                     | 660-663           |
| Levier                     | 389-392           |
| Levier d'embrayage         | 397               |
| Levier de décompresseur    | 400               |
| Levier de frein            | 389-401 ; 714-715 |
| Levier de starter          | 403               |
| Levier poignée             | 389-406           |
| Limiteur régime moteur     | 31                |
| Liquide biologique         | 636               |
| Liquide de frein           | 599, 616          |
| Liquide de refroidissement | 616               |
| Loupe/lentille             | 327               |
| Lubrifiant                 | 597-624           |
| Lubrification              | 160               |
| Lunettes                   | 581-582           |
| Lustreur                   | 635               |

|                          |                    |
|--------------------------|--------------------|
| <b>M</b>                 |                    |
| Mâchoire d'embrayage     | 222                |
| Mâchoire de frein        | 472-523            |
| Maillet                  | 649                |
| Maître cylindre de frein | 531-532            |
| Manchon                  | 583                |
| Manchon filtre à air     | 45                 |
| Manchon sélecteur        | 70                 |
| Marche-pieds             | 435                |
| Masque                   | 581-582            |
| Masque optique           | 282-312            |
| Masselotte               | 211, 213           |
| Mastic                   | 631                |
| Maxi-scooters            | 676-719            |
| Mécanisme de pompe à eau | 157, 161 ; 693-694 |

|                            |             |
|----------------------------|-------------|
| Mèche intérieure           | 625         |
| Mèche/tresse de réparation | 627         |
| Membrane pompe à essence   | 671         |
| Montre                     | 365         |
| Mordache                   | 637         |
| Moteur                     | 92          |
| Mousse de guidon           | 374-376     |
| Mousse de levier de frein  | 402         |
| Mousse filtre à air        | 45-49 ; 684 |
| Moyeu                      | 211, 213    |

|  |                  |
|--|------------------|
| <b>N</b>                               |                  |
| Navette/curseur poignée de gaz         | 403              |
| Nécessaire de réparation               | 625-628          |
| Nécessaire de réparation chambre à air | 628              |
| Néon                                   | 352              |
| Nettoyage gicleur                      | 646              |
| Nettoyant                              | 632-635          |
| Noix de kick                           | 441-442          |
| Numéro                                 | 269-270, 661-663 |

|                              |          |
|------------------------------|----------|
| <b>O</b>                     |          |
| Obturbateur de pompe à huile | 161, 163 |
| Optique                      | 323-237  |
| Ouïe avant                   | 308-311  |
| Outil réparation de valve    | 626      |
| Outil rodage soupape moteur  | 643      |
| Outils                       | 637-651  |

|                               |                |
|-------------------------------|----------------|
| <b>P</b>                      |                |
| Pad latéral                   | 293-294        |
| Pantalon de pluie             | 578            |
| Passage de roue               | 282-303, 313   |
| Pâte à joint                  | 629            |
| Pâte à pneu                   | 626            |
| Pâte à roder                  | 643            |
| Pâte d'étanchéité             | 629            |
| Patin Solex                   | 674            |
| Patte pot d'échappement       | 173-177, 186   |
| Patte/support fixation        | 358            |
| Pédale                        | 438, 674       |
| Pédale de frein               | 436            |
| Pédale lanceur                | 437            |
| Peigne de filetage            | 642            |
| Phare                         | 323-352        |
| Pièces détachées roues        | 571-572        |
| Pierre rodoir de cylindre     | 645            |
| Pige de calage                | 642            |
| Pignon                        | 249-250        |
| Pignon boîte de vitesse       | 239            |
| Pignon lanceur démarreur      | 31 ; 682       |
| Pignon poulie ER2/ER8         | 234-235        |
| Pile                          | 36             |
| Pince à clip                  | 649            |
| Pinceau pâte à pneu           | 625            |
| Pipe carter                   | 91             |
| Pipe d'admission              | 76-79 ; 688    |
| Pistolet de gonflage          | 626            |
| Piston                        | 122-135        |
| Plaque cache numéros          | 304            |
| Plaque d'immatriculation      | 658-667        |
| Plaquette de frein            | 472-523        |
| Plomb                         | 663            |
| Pneu cyclo                    | 562-564        |
| Pneu moto                     | 551-561        |
| Pneu scooter                  | 535-550        |
| Pneumatique                   | 535-572        |
| Pochette de joint haut moteur | 141, 148 ; 690 |
| Pochette de joint moteur      | 140 ; 690      |
| Poignée de frein              | 393-400 ; 716  |
| Poignée de gaz                | 400-402        |
| Poignée levier                | 389-406        |
| Poignée maintien              | 284            |
| Poinçon                       | 644            |
| Pompe à essence               | 73 ; 706       |

|                              |                   |
|------------------------------|-------------------|
| Pompe à huile                | 160, 163          |
| Pompe amortisseur            | 451               |
| Pompe vidange                | 649               |
| Pontet                       | 376               |
| Porte ampoule/lampe          | 358               |
| Porte-bagage                 | 318, 594          |
| Porte-clé                    | 388               |
| Pot                          | 166-189 ; 695-696 |
| Potence                      | 372-374           |
| Poulie                       | 234-235           |
| Poulie d'embrayage           | 234               |
| Poulie motrice               | 221               |
| Poumon                       | 57                |
| Produit anti-fuite radiateur | 629               |
| Produit stop/fuite           | 625               |
| Projecteur                   | 359-360           |
| Protection                   | 589-590           |
| Protection de fourche        | 457               |
| Protection latérale          | 293-294           |
| Protection réservoir         | 271               |
| Protège jambe                | 586-589           |
| Purgeur                      | 638               |

|                                   |                   |
|-----------------------------------|-------------------|
| <b>R</b>                          |                   |
| Raccord/connecteur en T           | 69                |
| Raccord/connecteur/coupe sécurité | 75                |
| Radiateur                         | 158               |
| Raidisseur de cadre               | 320               |
| Rampe                             | 213               |
| Rapeur                            | 625               |
| Recharge cheville                 | 625               |
| Récupérateur cylindre             | 190               |
| Récupérateur d'air                | 307               |
| Récupérateur de fluide            | 623               |
| Refrigerateur                     | 164               |
| Réglage amortisseur               | 637               |
| Réglage culbuteur                 | 642               |
| Régulateur de pression injection  | 688               |
| Régulateur de tension             | 26-27 ; 680       |
| Réhausse d'amortisseur            | 449               |
| Relai de démarreur                | 680               |
| Renfort garde-boue                | 314               |
| Reniflard                         | 315               |
| Réparation pneu spécial ciment    | 625               |
| Réparation/maintenance            | 625-636           |
| Repères bougies d'allumage        | 37                |
| Repose-pied                       | 435-436           |
| Réservoir                         | 705               |
| Réservoir auxiliaire              | 649               |
| Résistance de clignotant          | 340               |
| Ressort disque d'embrayage        | 220               |
| Ressort embrayage                 | 217-218 ; 701     |
| Ressort fourche                   | 457               |
| Ressort kick                      | 441, 444          |
| Ressort levier frein              | 403               |
| Ressort moteur                    | 212               |
| Ressort noix kick                 | 442               |
| Ressort silencieux                | 191               |
| Ressort variateur                 | 205-206 ; 698-699 |
| Rétroviseur                       | 414-429 ; 717-719 |
| Revêtement                        | 407-413           |
| Rivet                             | 658               |
| Robinet essence                   | 71-72 ; 705-706   |
| Rocher de kick                    | 442               |
| Rodoir de cylindre                | 645               |
| Rondelle                          | 652               |
| Rondelle axe de kick              | 442               |
| Rondelle bague support moteur     | 92                |
| Rondelle calage                   | 208               |
| Rondelle pédalier                 | 438               |
| Rotor                             | 17, 21            |
| Rotule                            | 190               |
| Roue-libre démarreur              | 679               |
| Rouleau tendeur de chaîne         | 263               |
| Roulement                         | 97-102            |
| Roulement arbre de roue           | 571               |
| Roulement roue                    | 234               |

|  |              |
|--|--------------|
| Roulement vilo et joint embiellage Solex | 672          |
| Roulement vilo et joint spi embiellage   | 99-102 ; 689 |
| Ruban adhésif                            | 631          |
| Rupteur                                  | 26 ; 682     |
| Rustine                                  | 628          |

|                                   |                  |
|-----------------------------------|------------------|
| <b>S</b>                          |                  |
| Sabot                             | 279-314          |
| Sabot moteur                      | 314              |
| Sacoche cyclo                     | 594              |
| Sangle                            | 594              |
| Savon                             | 636              |
| Segment                           | 103-121 ; 691    |
| Sélecteur de vitesse              | 445-446          |
| Selle                             | 321-322 ; 719    |
| Serre-câble                       | 653-654          |
| Serre-tringle                     | 654              |
| Siège de membrane pompe à essence | 671              |
| Siège enfant                      | 592              |
| Silencieux/cartouche              | 173-177, 185-190 |
| Silentbloc                        | 176-177          |
| Silentbloc bras oscillant         | 434              |
| Sonde de température              | 163              |
| Soufflette                        | 649              |
| Sous gant                         | 580              |
| Starter                           | 64, 70           |
| Stator                            | 17, 19-25, 681   |
| Support moteur                    | 92               |
| Support pour stand                | 651              |
| Support pour vignette assurance   | 590              |
| Support smartphone                | 590              |
| Sur gant                          | 580              |

|                          |                |
|--------------------------|----------------|
| <b>T</b>                 |                |
| Tablier                  | 583-589        |
| Tablier carrosserie      | 589-590        |
| Tambour d'embrayage      | 216, 221 ; 702 |
| Tampon de fourche        | 457            |
| Té de fourche            | 453-456        |
| Tendeur de chaîne        | 263            |
| Testeur de batterie      | 36             |
| Tête de fourche          | 308-319        |
| Tire valve               | 626            |
| Top-case/sacoche         | 591-595        |
| Tour de cou              | 580            |
| Tourillon                | 403            |
| Tournevis                | 646, 649       |
| Transmission d'embrayage | 526            |
| Transmission de compteur | 369-371 ; 712  |
| Transmission de frein    | 524-528 ; 713  |
| Transmission de gaz      | 525-528 ; 713  |
| Transmission de starter  | 526            |
| Trappe essence           | 308-311        |
| Trappe moteur            | 276-308        |
| Tresse de masse          | 30             |
| Tringle de garde-boue    | 673            |
| Turbine                  | 157            |
| Tuyau aspiration         | 671            |
| Tuyau refolement         | 671            |

|                          |                   |
|--------------------------|-------------------|
| <b>V</b>                 |                   |
| Variateur                | 192-213 ; 697-700 |
| Veste de pluie           | 578               |
| Vêtement                 | 577-580           |
| Vis 6 pans               | 652               |
| Vis capotage             | 655               |
| Vis carrosserie          | 655               |
| Vis carter               | 655               |
| Vis cloche d'embrayage   | 222               |
| Vis creuse               | 654               |
| Vis d'embrayage          | 655               |
| Vis épaulement           | 69                |
| Vis et agrafe            | 655               |
| Vis et écrou de carénage | 657               |
| Vis purge                | 531               |
| Visserie                 | 652-657           |

# INDEX ANGLAIS

## A

Admission pipe ..... 76-79 ; 688  
 Admission pipe gasket ..... 77,146  
 Aerosol anti-puncture ..... 625  
 Aerosol paint ..... 273-275  
 Air chamber ..... 57  
 Air filter ..... 44-45 ; 683-684  
 Air filter adaptater ..... 56  
 Air filter collar ..... 50  
 Air filter foam ..... 45-49 ; 684  
 Air filter sleeve ..... 45  
 Air inlet ..... 297-303  
 Air intake front ..... 308-311  
 Air recuperator ..... 307  
 Alarm ..... 388,575  
 Apron ..... 583-589  
 Aspiration pipe ..... 671  
 Awl ..... 644  
 Axle for engine ..... 92  
 Axle for flyweights ..... 211-207  
 Axle for gear selector ..... 239  
 Axle for pedals ..... 438  
 Axle for stand ..... 674

## B

Back rest ..... 291-292,303  
 Back rest passenger ..... 592  
 Back rest top case ..... 592  
 Balaclava ..... 580  
 Ball clutch ..... 213  
 Ball head ..... 190  
 Ball variator ..... 213  
 Battery ..... 32-36  
 Battery (small) ..... 36  
 Battery acid ..... 36  
 Battery tester ..... 36  
 Bearing ..... 97-102  
 Bearing needle ..... 127-135  
 Bearing ring ..... 213  
 Belt ..... 223-233 ; 703-705  
 Belt Oil pump ..... 161  
 Belt water pump ..... 164  
 Bleeder ..... 638  
 Bleeding screw ..... 531  
 Blowgun ..... 649  
 Bodywork ..... 276-320  
 Bodywork screw ..... 655  
 Bodywork apron ..... 589-590  
 Brake caliper gasket ..... 531  
 Brake caliper spacer ..... 452  
 Brake disc ..... 458-471  
 Brake handle/lever ..... 393-400 ; 716  
 Brake lever ..... 389-401 ; 714-715  
 Brake lever foam ..... 402  
 Brake lever spring ..... 403  
 Brake light contactor ..... 358,406  
 Brake liquid ..... 599,616  
 Brake pad ..... 472-523  
 Brake pad retractor ..... 638  
 Brake pad Solex ..... 674  
 Brake pedal ..... 436  
 Brake shoe ..... 472-523  
 Brake transmission ..... 524-528 ; 713  
 Braking ..... 674  
 Breather hose ..... 315  
 Buffer ..... 625  
 Buffer rubber ..... 673  
 Buffer rubber engine bottom ..... 92  
 Buffer rubber engine top ..... 92  
 Bulb socket ..... 235,361,642  
 Bulb socket ..... 358

## C

Cable Brake ..... 524,526 ; 713  
 Cable decompression ..... 528

Cable greaser ..... 623  
 Cable guide bend ..... 60,69  
 Cable speedometer ..... 369-371 ; 712  
 Cable Starter ..... 526  
 Cable Starter ..... 64,70  
 Cable Throttle ..... 525-528 ; 713  
 Cable Universal ..... 527  
 Calculator digimax ..... 19,23  
 Camera onboard ..... 366  
 Camshaft ..... 693  
 Cap air venting ..... 315,386  
 Cap decompression ..... 139  
 Cap key switch ..... 385  
 Cap Oil ..... 238-239  
 Cap petrol ..... 385-387 ; 705  
 Cap sump ..... 140  
 Captor CDI ..... 20,25  
 Captor speed ..... 363  
 Carburetor ..... 58-62 ; 687  
 Carburetor gasket ..... 69  
 Carburetor inlet ..... 58-63 ; 687  
 Carburetor link bend ..... 64  
 Carburetor reservoir ..... 69  
 CDI ..... 28 ; 677  
 CDI coil high tension ..... 28-29 ; 678  
 Chain ..... 259-263  
 Chain link clip ..... 259-262  
 Chain tension roller ..... 263  
 Chain tensioner ..... 263  
 Chain tensioner gasket ..... 143  
 Chain tool ..... 644  
 Charger battery ..... 35  
 Charger cigarette lighter ..... 366  
 Child's seat ..... 592  
 Circuit breaker ..... 388  
 Clamp cable ..... 653-654  
 Clamp rod ..... 654  
 Cleaner ..... 632-635  
 Clip ..... 127  
 Clip clutch ..... 222  
 Clip pedal ..... 438  
 Clips pliers ..... 649  
 Clothing ..... 577-580  
 Clutch ..... 214-222 ; 701-702  
 Clutch bell ..... 215-222 ; 702  
 Clutch bell ..... 216,221 ; 702  
 Clutch bell nut ..... 208,213  
 Clutch bell screw ..... 222  
 Clutch disc ..... 219-222 ; 702  
 Clutch disc spring ..... 220  
 Clutch housing gasket ..... 89  
 Clutch lever ..... 397  
 Clutch link ..... 221  
 Clutch nut ..... 208,213  
 Clutch pulley ..... 234  
 Clutch remover ..... 641  
 Clutch screw ..... 655  
 Clutch shoe ..... 222  
 Clutch spring ..... 217-218 ; 701  
 Clutch transmission ..... 526  
 Cog ..... 249-250  
 Coil ..... 18,25  
 Coil high tension ..... 17,27 ; 677  
 Collar ..... 429  
 Colonette ..... 211  
 Column ring ..... 211  
 Combination switch ..... 404-406 ; 716  
 Condensator ..... 25 ; 682  
 Connector ..... 648  
 Connector T shape ..... 69  
 Connector/security shutoff ..... 75  
 Contact breaker ..... 26 ; 682  
 Coolant ..... 616  
 Coolant hose collar ..... 164  
 Cooler ..... 164  
 Cotter cog ..... 239

Cotter ignition ..... 29-30  
 Counter demultiplier ..... 367-368  
 Counter weights ..... 207,211,213  
 Cover ..... 88  
 Cover air filter ..... 670  
 Cover cog ..... 314  
 Cover engine ..... 159  
 Cover flywheel ..... 30  
 Cover ignition ..... 315  
 Cover kick/variator ..... 209  
 Cover master cylinder ..... 533  
 Cover rear brake ..... 533  
 Cover rivet ..... 658  
 Cover transmission ..... 237  
 Cover turbine ..... 159-160,306  
 Cover/case pipe ..... 91  
 Cover/crankcase screw ..... 655  
 Cowling dashboard ..... 277-305  
 Cowling front ..... 279-316  
 Cowling front apron bottom ..... 293  
 Cowling front apron top ..... 293  
 Cowling motor ..... 291  
 Cowling radio ..... 284  
 Cowling rear ..... 276-312  
 Cowling rear junction ..... 286-288  
 Cowling saddle ..... 291-292  
 Cowling screw ..... 655  
 Cowling side ..... 293-294  
 Cowling underbody ..... 277-304  
 crankcase engine ..... 641  
 Crankcase gasket ..... 144,150  
 Crankcase valve ..... 80-87 ; 687  
 Crankshaft ..... 93-95 ; 688-689  
 Crankshaft/variator oil seal gasket ..... 146,153  
 Cylinder ..... 103-121  
 Cylinder gasket ..... 103-121  
 Cylinder /base gasket ..... 143,145,149  
 Cylinder head ..... 136-139 ; 693  
 Cylinder head gasket ..... 144,149,151  
 Cylinder honing tool ..... 645  
 Cylinder piston gasket set ..... 141,148 ; 690  
 Cylinder recuperator ..... 190

## D

Decompression ..... 653-654  
 Decompression lever ..... 400  
 Decoration ..... 273-275  
 Direction set ..... 454-457 ; 707-708  
 Double visor anti-moisture ..... 582  
 Drive pulley ..... 221

## E

Earthing plait ..... 30  
 Electric connectors ..... 647-648  
 Engine ..... 92  
 Engine axel nut ..... 92  
 Engine gasket ..... 140,151  
 Engine gasket set ..... 140 ; 690  
 Engine hatch ..... 276-308  
 Engine oil seal gasket ..... 140,152  
 Engine spring ..... 212  
 Engine support ..... 92  
 Engine support link ..... 92  
 Engine support ring washer ..... 92  
 Engine top end gasket ..... 141-143,147-149  
 Engine valve grinding tool ..... 643  
 Ensemble 2 parts jacket & trousers ..... 579  
 Epoxy ..... 631  
 Exhaust ..... 166-191 ; 695-696  
 Exhaust fittings ..... 173-177,186  
 Exhaust gasket ..... 145,155  
 Exhaust pipe ..... 166-189 ; 695-696  
 Exhaust ring ..... 185

## F

File ..... 625

Filter/clutch bell/flywheel grip ..... 640  
 Fittings ..... 358  
 Fixed flange nut ..... 211,213  
 Fixed flange star ..... 208-209  
 Flange fixed ..... 203-204  
 Flange mobile ..... 211,213  
 Flat gasket ..... 156  
 Flyweights ..... 211,213  
 Flywheel cover flange ..... 670  
 Foot rests ..... 435-436  
 Footboards ..... 435  
 Fork ..... 452 ; 709  
 Fork head cowling ..... 308-319  
 Fork oil seal gasket ..... 455-456 ; 708  
 fork pad ..... 457  
 Fork protection ..... 457  
 Fork spring ..... 457  
 Fork T ..... 453-456  
 Fountain organic ..... 636  
 Frame reinforcer ..... 320  
 Funnel ..... 649  
 Fuse ..... 646

## G

Gasket ..... 140-156 ; 690-691  
 Gasket paste ..... 629  
 Gasket remover ..... 649  
 Gear box ..... 238  
 Gear box pignon/sprocket ..... 239  
 Gear selector shaft ..... 239  
 Gear Selection barrel ..... 403  
 Gear selector ..... 445-446  
 Gears ..... 236-239  
 Glasses/goggles ..... 581-582  
 Glove (over) ..... 580  
 Glove liner ..... 580  
 Gloves workshop ..... 636  
 Glue ..... 630-631  
 Goggle ..... 581-582  
 Grease ..... 620  
 Grill fork ..... 319  
 Grill protection/decoration ..... 320  
 Grill rear cowling ..... 277-278  
 Grinder disc ..... 650  
 Grinding paste ..... 643  
 Grinding stone cylinder ..... 645  
 Grip ..... 407-413

## H

Half-collar ..... 190,429  
 Handlebar ..... 372-380  
 Handlebar cap ..... 380  
 Handlebar foam ..... 374-376  
 Handlebar mountings ..... 376  
 Handlebar raiser ..... 372-374  
 Headlight ..... 323-352  
 Headlight double ..... 324-326  
 Hexagonal Nut ..... 652  
 Hexagonal screw ..... 652  
 Hollow screw ..... 654  
 Hooter ..... 405  
 Horn ..... 405  
 Horn contactor ..... 405  
 Hose oil pump ..... 164  
 Hose water ..... 159,162,164  
 Housing gasket ..... 90,92  
 Housing calculator ..... 19,23  
 Hub ..... 211,213  
 Hydraulic brake caliper ..... 530

## I

Ignition ..... 16-32 ; 677-682  
 Ignition electronics ..... 16-24  
 Ignition housing gasket ..... 89-90  
 Ignition nut ..... 29  
 Ignition switch barrel ..... 403  
 Indicator ..... 328-340  
 Indicator central control ..... 31,332-340  
 Indicator resistance ..... 340  
 Inflation end piece ..... 627

# INDEX ANGLAIS

Injection pressure regulator ..... 688  
 Inner tube ..... 565-567  
 Inner tube patch ..... 628  
 Inner tube repair kit ..... 628  
 Interference eliminator ..... 41-43

**J**  
 Jacket ..... 578  
 Jacket security ..... 579  
 Jerrycan ..... 649  
 Jet ..... 645  
 Jet cleaner ..... 646  
 Jet reamers ..... 645

**K**  
 Key ring ..... 388  
 Key switch contactor ... 381-384 ; 713-714  
 Kick axel washer ..... 442  
 Kick start ..... 439-444  
 Kick start launcher spring ..... 442  
 Kick start launching screw ..... 441-442  
 Kick start spring ..... 441,444  
 Kick wheel ..... 442  
 Kick/variator housing gasket ..... 144  
 Kit bleeder ..... 638  
 Kit bodywork ..... 276-312 ; 710  
 Kit chain ..... 240-248  
 Kit maintenance ..... 618  
 kit repair ..... 69-70  
 Kit repair master cylinder ..... 533

**L**  
 Laminator ..... 658  
 Lamp/bulb ..... 354-357  
 Lateral protection ..... 293-294  
 Lead ..... 663  
 Leak detector ..... 625  
 Lens indicator ..... 331-335 ; 711  
 Lens rear light ..... 344-350  
 Letter ..... 660-663  
 Lever ..... 389-392  
 Lever handle ..... 389-406  
 Lever handle ..... 389-406  
 Light ..... 323-352 ; 711  
 Light bulb ..... 354-357  
 Lighting ..... 323-361 ; 711  
 Lighting N° plate ..... 327  
 Liquid organic ..... 636  
 Liquid recuperator ..... 623  
 Locks ..... 574-576  
 Lubricant ..... 597-624  
 Lubrication ..... 160  
 Luggage rack ..... 318,594

**M**  
 Magnifier / lens ..... 327  
 Mallet ..... 649  
 Master brake cylinder ..... 531-532  
 Master cylinder cover ..... 533  
 Master cylinder gasket ..... 531  
 Master cylinder jar ..... 533  
 Maxi-scooters ..... 676-719  
 Metal cutter ..... 650  
 Mobile flange ring ..... 211  
 Moped tyre ..... 551-561  
 Mounting bearing ..... 631  
 Mounting for fork cowlings ..... 452  
 Mounting for hand protectors ..... 377  
 Mud guard ..... 277-319  
 Mud guard reinforcer ..... 314  
 Mud guard rod ..... 673  
 Muffler ..... 173-177,185-190  
 Multi-curve box ..... 24

**N**  
 N° plate ..... 658-667  
 N° Plate ..... 658-667  
 N° Plate band ..... 659-667  
 N° Plate printer ..... 658,664  
 Neck warmer ..... 580  
 Neon ..... 352  
 Number ..... 269-270,661-663  
 Nut hexagonal ..... 652  
 Nuts & bolts ..... 652-657

**O**  
 Oil ..... 598-615  
 Oil change pump ..... 649  
 Oil doser ..... 623  
 oil filter ..... 685-687  
 Oil filter remover ..... 643  
 Oil pump ..... 160,163  
 Oil pump body gasket ..... 151  
 Oil pump cover ..... 161,163  
 On/off contactor ..... 357-358,406  
 Optic ..... 323-237  
 Optic bubble ..... 325  
 Optic mask ..... 282-312  
 Outlet pipe ..... 671

**P**  
 Pad side ..... 293-294  
 Paper roll ..... 636  
 Pedal moped tyre ..... 562-564  
 Pedal ring ..... 438  
 Pedal washer ..... 438  
 Pedals ..... 438,674  
 Pencil tyre ..... 275  
 petrol filter ..... 74-75  
 Petrol hatch ..... 308-311  
 petrol hose ..... 73-74  
 Petrol hose collar ..... 74  
 Petrol pump ..... 73 ; 706  
 Petrol pump membrane ..... 671  
 Petrol pump membrane seat ..... 671  
 Petrol tank ..... 705  
 Petrol tank auxiliary ..... 649  
 Petrol tank protection ..... 271  
 petrol tap ..... 71-72 ; 705-706  
 Piston ..... 122-135  
 Piston ring ..... 103-121 ; 691  
 Pneumatics ..... 535-572  
 Polish ..... 635  
 Precision scale ..... 642  
 Press button ..... 406  
 Projector ..... 359-360  
 Protection ..... 589-590  
 Protector leg ..... 586-589  
 Puller bearings ..... 641  
 Puller flywheel ..... 639-640  
 Puller Variator ..... 211  
 Pulley ..... 234-235  
 Pulley sprocket ER2/ER8 ..... 234-235  
 Puncture prevention ..... 625  
 Puncture repair interior ..... 625  
 Puncture repair exterior ..... 627  
 Putty/filler ..... 631

**R**  
 Radiator ..... 158  
 Rain jacket ..... 578  
 Rain suit ..... 577  
 Ramp ..... 213  
 Reed for reed valve ..... 82  
 Reed valve ..... 80-87 ; 687  
 Reed valve box ..... 80-81  
 Reed valve gasket ..... 145,150  
 Reel ..... 649  
 Repair Kit ..... 625-628

Repairs/maintenance ..... 625-636  
 Retaining ring kick axel ..... 442  
 Retention handle/lever ..... 284  
 Rev limiter ..... 31  
 Revometer ..... 365  
 Riisan collar ..... 631  
 rivet ..... 658  
 Rocker arm shaft adjuster ..... 642  
 Rollers ..... 194-199  
 Rotor ..... 17,21  
 Rotor/variator/clutch nut ..... 208  
 Rubber buffer oscillating arm ..... 434

**S**  
 Sabot ..... 279-314  
 Saddle ..... 321-322 ; 719  
 Satchel pedal moped ..... 594  
 Scooter tyre ..... 535-550  
 Scratch remover ..... 635  
 Satchel pedal moped ..... 594  
 Screw & staple ..... 655  
 Screw with fixed washer ..... 69  
 Screwdriver ..... 646,649  
 Selector sleeve ..... 70  
 Self breaking nut ..... 385  
 Serial N° cover ..... 304  
 Sheath ..... 529  
 Sheath cap ..... 653  
 Sheath stopper ..... 653  
 Sheet carbon ..... 83  
 Sheet fibre ..... 156  
 Shock absorber adjuster ..... 637  
 Shock absorber extension ..... 449  
 Shock absorber pump ..... 451  
 Shock absorber spring compressor ..... 637  
 Shock absorbers ..... 447-451 ; 706-707  
 Silencer collar ..... 173-190  
 Silencer gasket ..... 152  
 Silencer spring ..... 191  
 Silencer wool ..... 191  
 Silentbloc ..... 176-177  
 Size & weights of original rollers .. 192-193  
 Sleeve ..... 583  
 Slipcover for protection ..... 589-590  
 Slipcover for saddle ..... 321-322  
 Soap ..... 636  
 Socket set ..... 650  
 Spanner spark plug ..... 638  
 Spanner spoke ..... 637  
 Spark plug ..... 37-43  
 Spark plug brush ..... 638  
 Spark plug marker ..... 37  
 Spark plug wire ..... 670  
 Speed codes ..... 536  
 Speedometer ..... 362-364  
 Speedometer cable cap ..... 371  
 Speedometer commandes adaptator ..... 363  
 Speedometer magnet ..... 363  
 Speedometer transmission ..... 369-371 ; 712  
 Spring remover/remounter ..... 649  
 Sprocket rear ..... 251-258  
 Sprocket starter ..... 208 ; 682  
 Square nut ..... 190  
 Stand vehicle ..... 430-434 ; 709  
 Starter free wheel ..... 679  
 Starter launcher pignon/sprocket. 31 ; 682  
 Starter lever ..... 403  
 Starter motor ..... 31 ; 678  
 Starter pedal ..... 437  
 Starter relay ..... 680  
 Starter transmission ..... 526  
 Starting aid ..... 36  
 Stator ..... 17,19-25,681  
 Sticker ..... 265-272  
 Sticky tape ..... 631  
 Stop leak product ..... 625  
 Stop leak radiator product ..... 629

Strap ..... 594  
 Stud ..... 178  
 Sump protector ..... 314  
 Support for insurance paper ..... 590  
 Support for smartphone ..... 590  
 Support for stand ..... 651  
 Supporting needle ..... 50

**T**  
 Temperature probe ..... 163  
 Tension/torque regulator ..... 26-27 ; 680  
 Thermostat ..... 158  
 Thread brake ..... 630-631  
 Thread comb ..... 642  
 Thread gauge ..... 642  
 Throttle limiter ..... 403  
 Throttle handle/lever ..... 400-402  
 Throttle transmission ..... 525-528 ; 713  
 Timing Chain ..... 137  
 Timing freeland ..... 642  
 Timing tensioner gasket ..... 137  
 Toe clip ..... 435  
 Tool box ..... 675  
 Tools ..... 637-651  
 Top case satchel ..... 591-595  
 Torque corrector ..... 217 ; 699  
 Transmission housing gasket ..... 144  
 Tread mesurer ..... 642  
 Trousers rain ..... 578  
 Trunion ..... 403  
 turbine ..... 157  
 Tyre anchor seal ..... 625  
 Tyre equivalence/dimensions ..... 535  
 Tyre inflating pistol ..... 626  
 Tyre paste ..... 626  
 Tyre paste brush ..... 625  
 Tyre remover ..... 626  
 Tyre repair special cement ..... 625  
 Tyre retractor ..... 626

**V**  
 Valve cap ..... 568-570  
 Valve core remover ..... 626  
 Valve extractor ..... 626  
 Valve non return ..... 638  
 Valve repair tool ..... 626  
 Valve remover ..... 643  
 Variator ..... 192-213 ; 697-700  
 variator & crankshaft  
 oil seal bearing ..... 99-102 ; 689  
 Variator bearing ..... 672  
 Variator cover ..... 208  
 Variator cover nut ..... 211  
 Variator Guide ..... 211  
 Variator nut ..... 29,207,211  
 Variator spring ..... 205-206 ; 698-699  
 Vehicule equipment ..... 583-590  
 Vise pads ..... 637  
 Visor glasses/goggle ..... 581-582

**W**  
 Warning light contactor ..... 357  
 Washer ..... 652  
 Watch ..... 365  
 Water pump gasket ..... 151  
 Water pump repair kit ... 157,161 ; 693-694  
 Waterproofing gasket ..... 156  
 Waterproofing paste ..... 629  
 Wedging washer ..... 208  
 Wheel bearing ..... 234  
 Wheel passage ..... 282-303,313  
 Wheel rim liner ..... 571-572  
 Wheel shaft bearing ..... 571  
 Wheel spare parts ..... 571-572  
 Wing mirror ..... 414-429 ; 717-719  
 Wing mirror adaptater ..... 429  
 Wire electric ..... 647

# INDEX SCOOTER

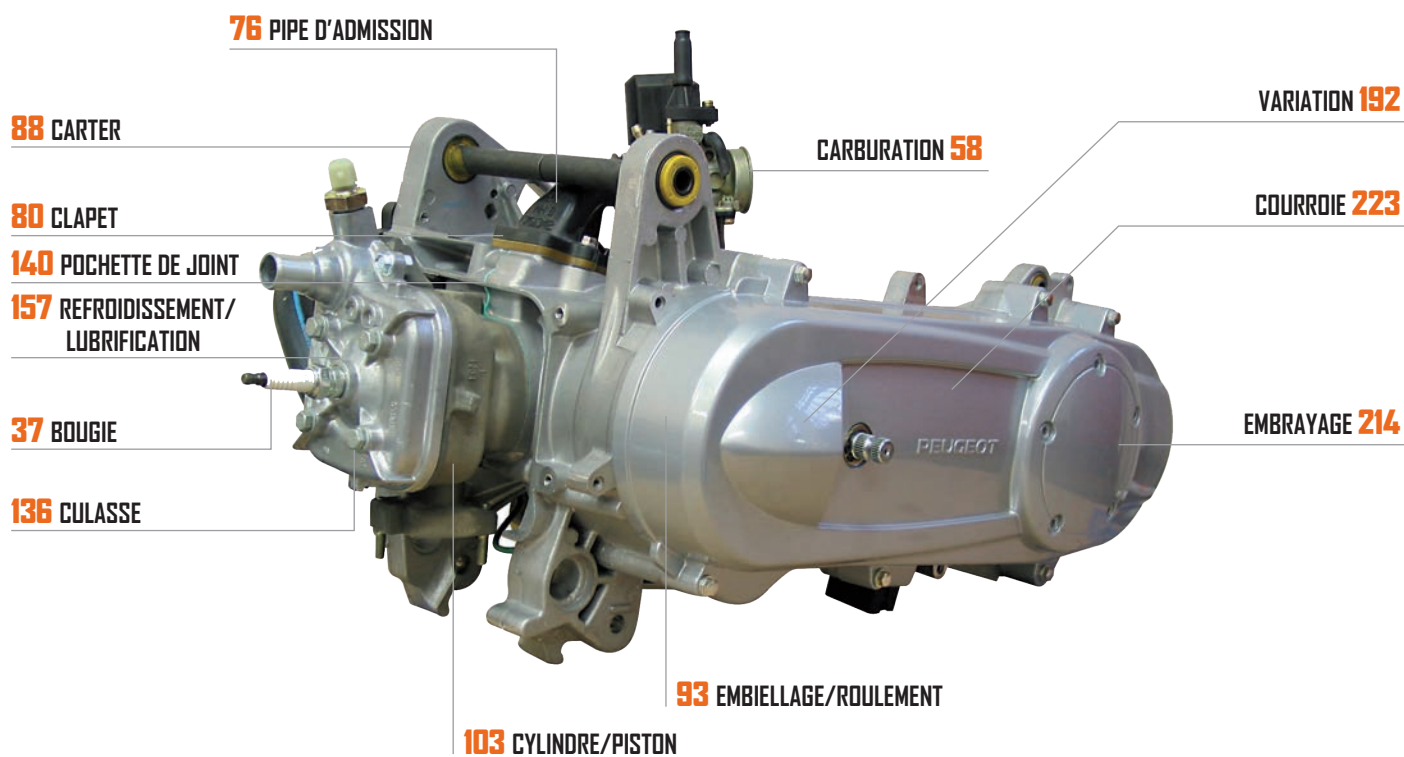

# INDEX 50 À BOÎTE

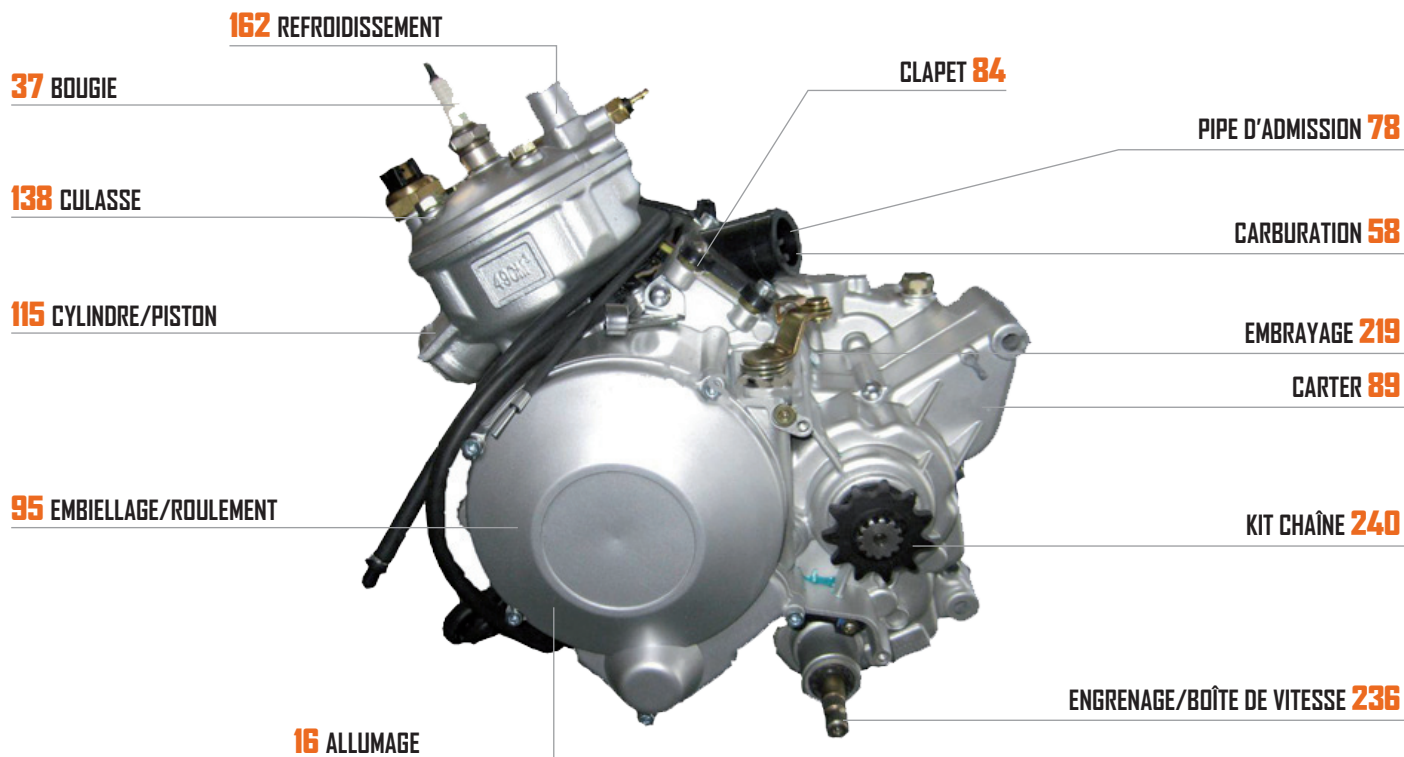

# INDEX CYCLO

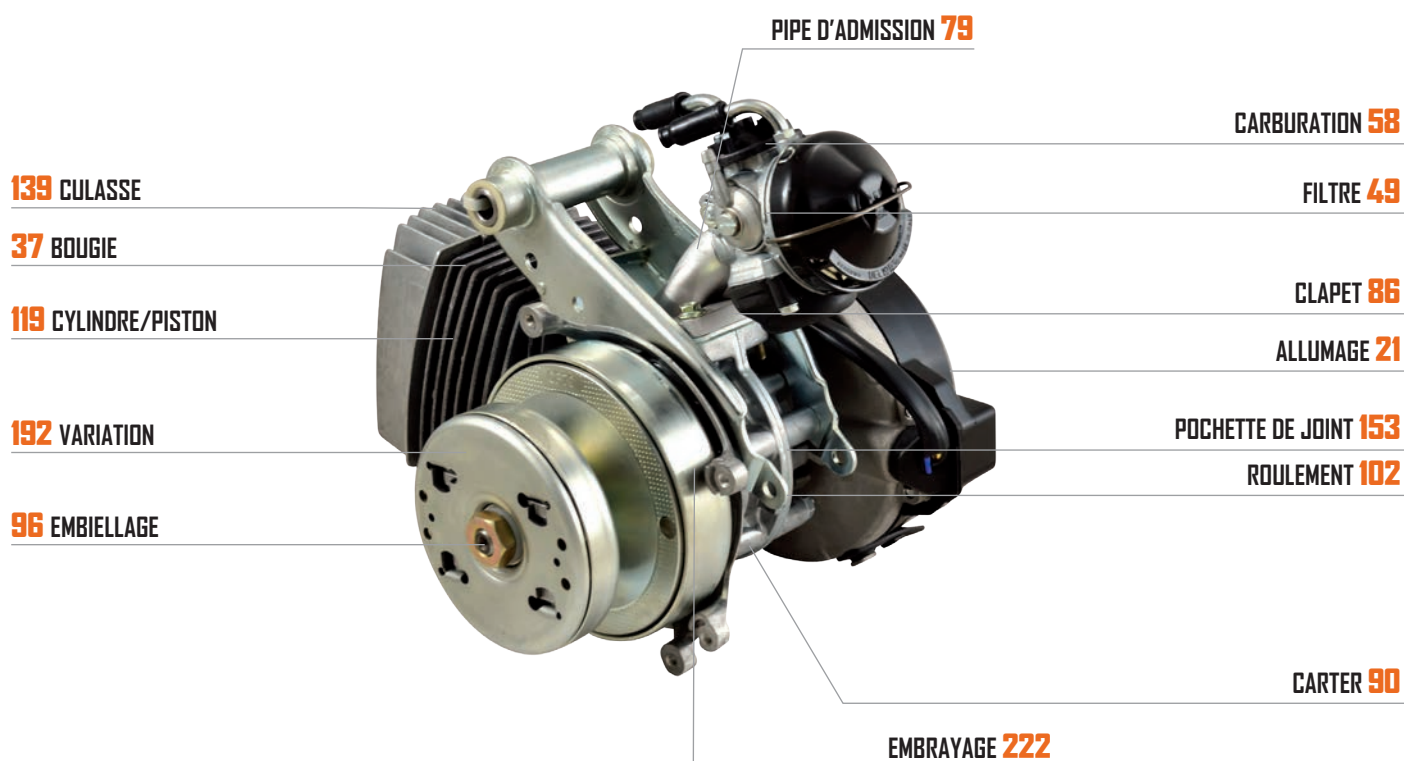

# INDEX MAXI-SCOOTER

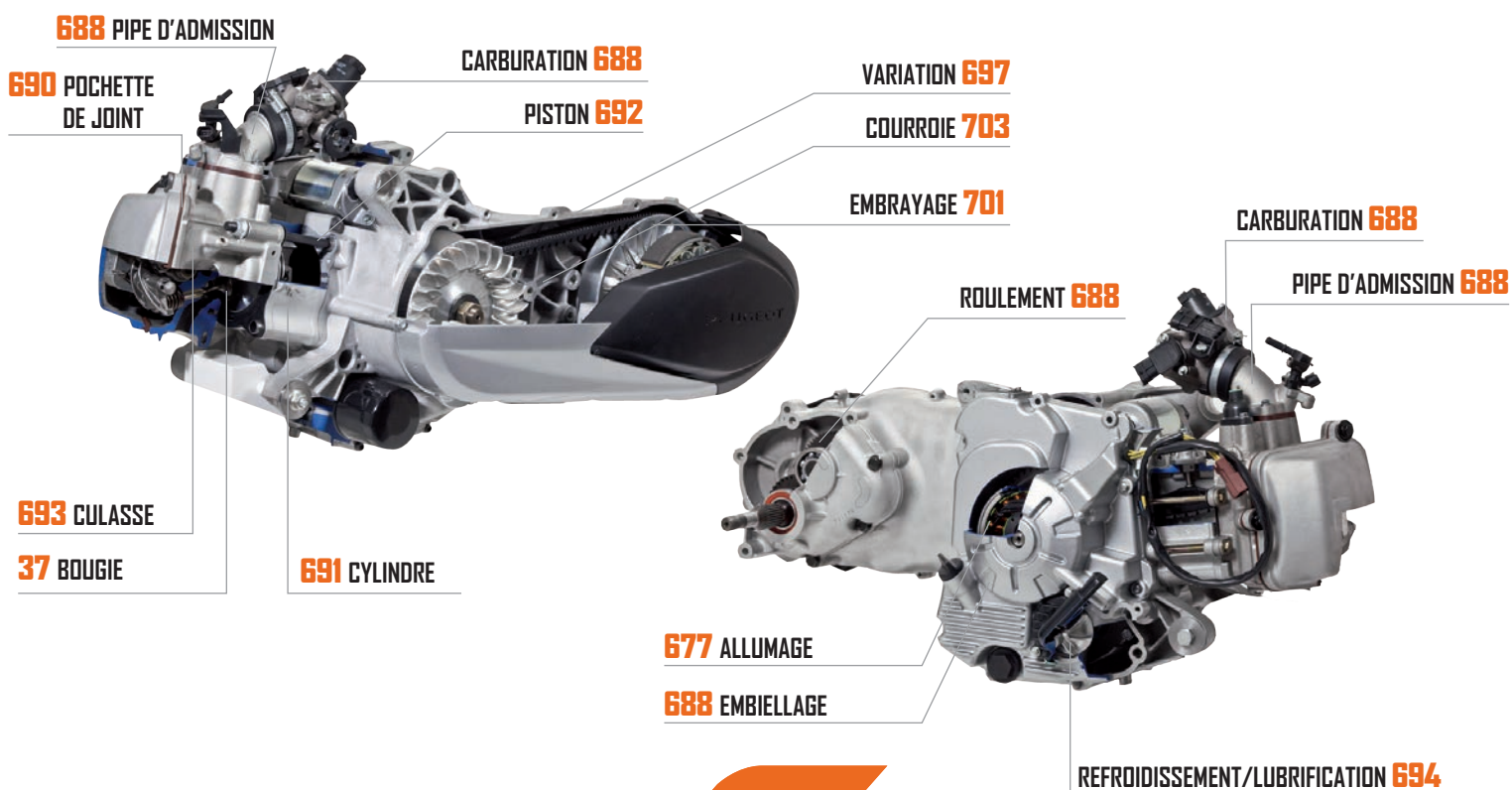

# VOTRE PARTENAIRE AU QUOTIDIEN



↳ **CONSULTER LES INFORMATIONS TECHNIQUES DE VOS PRODUITS**

↳ **DEMANDER DE L'AIDE À WINIX, NOTRE MESSAGERIE INSTANTANÉE**

↳ **AFFICHER LES TARIFS DÉTAILLANTS OU PUBLICS SELON VOTRE PRÉFÉRENCE**

↳ **LA DATE DE DISPONIBILITÉ DE VOS PRODUITS S'AFFICHE AUTOMATIQUEMENT**



# MOTEUR

|                   |     |
|-------------------|-----|
| Allumage          | 16  |
| Batterie          | 32  |
| Bougie            | 37  |
| Carburateur       | 58  |
| Carter            | 88  |
| Chaîne            | 259 |
| Clapet            | 80  |
| Courroie          | 223 |
| Couronne          | 251 |
| Culasse           | 136 |
| Cylindre          | 103 |
| Échappement       | 166 |
| Embiellage        | 83  |
| Embrayage         | 214 |
| Engrenage         | 238 |
| Filtre            | 44  |
| Joint             | 140 |
| Kit chaîne        | 240 |
| Lubrification     | 160 |
| Pignon/Couronne   | 249 |
| Pipes d'admission | 76  |
| Piston            | 122 |
| Poulie            | 234 |
| Refroidissement   | 157 |
| Roulement         | 87  |
| Schéma couronne   | 246 |
| Schéma Pignon     | 245 |
| Variation         | 192 |



## ALLUMAGE / IGNITION

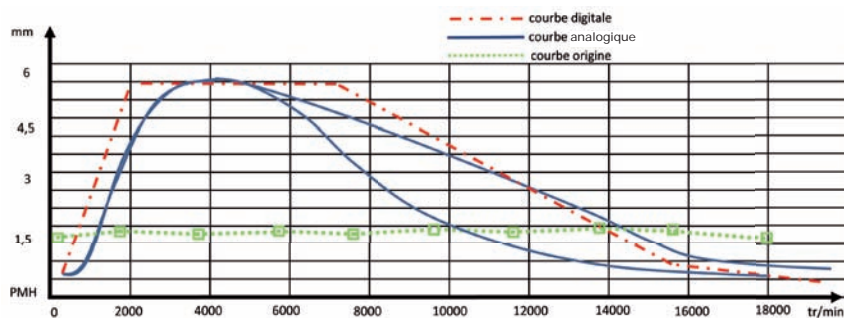

- ↳ L'avantage de l'allumage digital est qu'il bénéficie d'une avance sectorisée.
- ↳ L'avantage de l'allumage analogique est qu'il bénéficie d'une avance linéaire.



### ALLUMAGE DIGITAL DIRECT

|        |                              |
|--------|------------------------------|
| 477230 | NITRO   BOOSTER 2004->       |
| 477234 | NITRO   BOOSTER ->2003       |
| 477229 | LUDIX   SPEEDFIGHT 3   JET   |
| 477231 | SPEEDFIGHT sans transpondeur |
| 477232 | avec éclairage TYPHOON       |



- ↳ L'avantage de l'allumage analogique est qu'il bénéficie d'une avance linéaire.
- ↳ La particularité de ce produit est son faible poids en rotation par rapport au rotor externe, ce qui permet d'avoir une montée en régime franche et un régime de rotation élevé.
- ↳ Il est possible d'alimenter un éclairage et une pompe à eau électriques.



### DIAGRAMME DIGITAL

|        |  |
|--------|--|
| 479759 | NITRO   X LIMIT->2003   SENDA   SPEEDFIGHT |
| 482532 | X-LIMIT   DT50 R   BOOSTER   NITRO 2       |
| 475248 | BOOSTER   STUNT   NITRO                    |



### ALLUMAGE ROTOR INTERNE AVEC ÉCLAIRAGE (ANALOGIQUE)

|        |                                     |
|--------|-------------------------------------|
| 475229 | NITRO   BOOSTER   AEROX catalysé    |
| 475223 | BOOSTER   BW'S non catalysé         |
| 475226 | LUDIX   JET                         |
| 475224 | SPEEDFIGHT sans transpondeur        |
| 475225 | TYPHOON   NRG   STALKER   DNA   ZIP |
| 475231 | CPI   KEEWAY                        |



- ↳ La particularité de ce produit est son faible poids en rotation par rapport au rotor externe, ce qui permet d'avoir une montée en régime franche et un régime de rotation élevé.
- ↳ Il est possible d'alimenter un éclairage et une pompe à eau électriques.
- ↳ L'avantage de l'allumage analogique est qu'il bénéficie d'une avance linéaire.



**DOPPLER**

## DIAGRAMME ANALOGIQUE ROTOR INTERNE

- 475248 BOOSTER | STUNT | NITRO | X LIMIT | DT | DTR 2004->
- 475247 SPEEDFIGHT | TREKKER | BUXY



**DOPPLER**

## BOBINE HAUTE TENSION

- 475232 PIAGGIO TYPHOON | STALKER | ZIP | FLY | NRG | ET2 2 temps



**DOPPLER**

## ROTOR

- 475233 BOOSTER | BW'S | STUNT | SLIDER | NITRO | AEROX tous modèles
- 475236 LUDIX | JET FORCE
- 475234 SPEEDFIGHT | TREKKER | BUXY
- 475235 PIAGGIO TYPHOON | STALKER | NRG
- 475239 CPI | KEEWAY



**DOPPLER**

## STATOR

- 475240 tous modèles





**MVT**

## ALLUMAGE DIGITAL DIRECT

|        |  |
|--------|--|
| 476896 | NITRO   AEROX   BOOSTER   BW'S 2004-> catalysé |
| 476889 | BOOSTER   BW'S   NITRO   AEROX ->2003          |
| 476894 | LUDIX   JET FORCE   VIVACITY 3   SPEEDFIGHT 3  |



**MVT**

## ALLUMAGE PREMIUM AVEC ÉCLAIRAGE (ANALOGIQUE)

|        |   |            |
|--------|---|------------|
| 468795 | NITRO   BOOSTER 2004-> ctalysé              | Prémium 19 |
| 468789 | BOOSTER   BW'S ->2003 non catalysé          | Prémium 6  |
| 468792 | LUDIX   JET FORCE   VIVACITY 3   SPEEDFIGHT | Prémium 10 |
| 468790 | SPEEDFIGHT sans transpondeur                | Prémium 8  |
| 468791 | TYPHOON   NRG   STALKER   ICE   ZIP   DNA   | Prémium 9  |



468795



468789

**MVT**

## ALLUMAGE MILLENIUM

|        |   |
|--------|---|
| 458151 | BOOSTER   BW'S   STUNT   SLIDER 2004->              |
| 388702 | BOOSTER   BW'S   STUNT   SLIDER non catalysé        |
| 458152 | NITRO   AEROX   OVETTO   MACH G   JOG R             |
| 388717 | NITRO   AEROX   SR50                                |
| 388721 | SPEEDFIGHT sans transpondeur   TREKKER              |
| 388736 | TYPHOON   NRG   RUNNER   STALKER   ICE   ZIP 2005-> |
| 466538 | KEEWAY   CPI  |
| 440703 | F10   F12   F15   SR50 allumage DUCATI              |



**MVT**

## BOBINE

|        |                              |
|--------|------------------------------|
| 388899 | pour allumage MVT et DOPPLER |
|--------|------------------------------|





**MVT**

## STATOR MILLENIUM

466202 BOOSTER | STUNT | NITRO | MACH G | JOG R ->2003



**MVT**

## CALCULATEUR DIGIMAX POUR ALLUMAGE MILLENIUM

|        |                                   |           |
|--------|-----------------------------------|-----------|
| 441472 | BOOSTER   STUNT   NITRO   OVETTO  | Digimax 3 |
| 441476 | BOOSTER   NITRO   OVETTO catalysé | Digimax 7 |



**MVT**

## DIAGRAMME MILLENIUM

|        |                                 |       |
|--------|---------------------------------|-------|
| 465609 | BOOSTER   NITRO non catalysé    | DI 04 |
| 465610 | BOOSTER   NITRO 2004-> catalysé | DI 05 |
| 465606 | TYPHOON NRG 2005->   F12        | DI 01 |

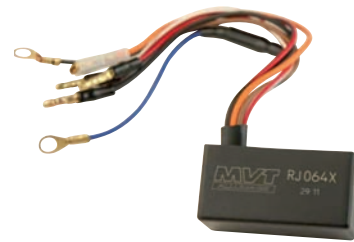

## ALLUMAGE AVEC ÉCLAIRAGE

|        |   |
|--------|---|
| 451405 | BOOSTER   BW'S   NEXT ->2003  |
| 451406 | NITRO   AEROX   SR   OVETTO   NEOS   EVOLIS   MACH G   JOG R ->2003 |
| 491692 | BOOSTER   BW'S   NEXT 2004->  |





### STATOR

|        |   |
|--------|---|
| 472797 | BOOSTER   BW'S ->2003 long fil                        |
| 472545 | BOOSTER   BW'S 2004->   NITRO   AEROX   OVETTO   NEOS |
| 472546 | NITRO   AEROX ->2003   CPI ->2005                     |
| 475174 | LUDIX   SPEEDFIGHT3   VIVACITY 3   KISBEE   DJANGO    |
| 467784 | SPEEDFIGHT   TREKKER   VIVACITY 6 pôles               |
| 476160 | TYPHOON   NRG   ZIP   STALKER 2005->   SR50   MOTARD  |
| 480352 | KEEWAY   CPI 50CC 2 temps                             |
| 480392 | SCOOTER CHINOIS   V CLIC   139QMB   AGILITY   FIDDLE  |
| 480390 | KYMCO DINK   PEOPLE 50CC                              |
| 450773 | TYPHOON   NRG   STALKER   ZIP   RUNNER ->2005         |

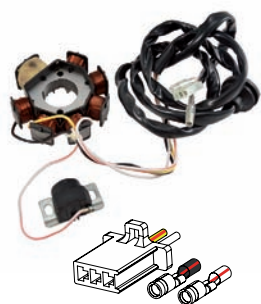

472797



472545



472546



475174



467784

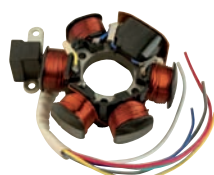

476160



480352



480392



480390



450773



### CAPTEUR CDI

|        |  |
|--------|--|
| 440262 | BOOSTER   BW'S   NITRO   AEROX   OVETTO   NEOS |
|--------|--|



ALLUMAGE / IGNITION



**DOPPLER**

**ALLUMAGE DIGITAL DIRECT AVEC ÉCLAIRAGE**

477233 X-LIMIT | DT50 R 2003->

477235 DERBI | SENDA | GPR



**DOPPLER**

**ALLUMAGE ROTOR INTERNE AVEC ÉCLAIRAGE**

475228 AM6 | XP6 | X-LIMIT démarrage kick, non catalysé

475227 DERBI | SENDA | GPR

475230 X-LIMIT | DT50R 2003->



**DOPPLER**

**DIAGRAMME DIGITAL**

479759 XLIMIT ->2003 | SENDA

482532 XLIMIT | DT50 R



**DOPPLER**

**ROTOR**

475238 XLIMIT | DT | DTR tous modèles

475237 DERBI | SENDA | GPR



**DOPPLER**

**STATOR**

475240 tous modèles



**TEKNIX**  
Digital Quality Controller

**ROTOR**

494807 CPI SM | SX



**TEKNIX**  
Digital Quality Controller

**STATOR**

491740 CPI SM | SX



**DOPPLER**

**DIAGRAMME ROTOR INTERNE**

475248 analogique X LIMIT | DT | DTR 2004->

482532 digital X-LIMIT | DT50 R





**MVT**

## DIAGRAMME MILLENIUM

|        |                                 |       |
|--------|---------------------------------|-------|
| 465606 | 51   TYPHOON NRG 2005->   F12   | DI 01 |
| 465608 | SP   MVL   SPX-RCX   FOX   FXR  | DI 03 |
| 465607 | DAKOTA   KANSAS   MBK PHENIX 20 | DI 02 |



**MVT**

## ALLUMAGE DIGITAL DIRECT AVEC ÉCLAIRAGE\*

|        |  |
|--------|--|
| 476897 | X-LIMIT   DT50 R 2003->                              |
| 476895 | AM6   XP6   X-LIMIT démarrage par kick, non catalysé |
| 476893 | DERBI   SENDA   GPR                                  |

- ↳ 0.4mm avant PMH pour un 50cc
- ↳ 0.35mm avant PMH pour cylindrée au dessus de 50cc
- ↳ 2.9mm avant PMH si boîtier eprom

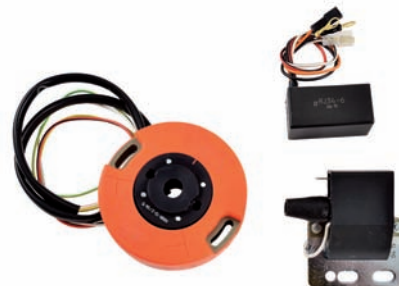

**MVT**

## ALLUMAGE INTÉGRAL SANS ÉCLAIRAGE DIGITAL DIRECT AVEC ÉCLAIRAGE\*

|        |                                     |
|--------|-------------------------------------|
| 335119 | AM6 rotor interne                   |
| 251097 | SENDA   GPR50   DERBI rotor interne |

- ↳ calage à 1.5mm avant PMH



**MVT**

## ALLUMAGE PREMIUM AVEC ÉCLAIRAGE

|        |  |            |
|--------|--|------------|
| 468794 | AM6   XP6   X-LIMIT démarrage par kick, non catalysé | Premium 12 |
| 468793 | DERBI   SENDA   GPR                                  | Premium 11 |
| 468796 | X-LIMIT   DT50 R 2003-> catalysé                     | Premium 21 |



**MVT**

## ALLUMAGE MILLENIUM AVEC ÉCLAIRAGE

|        |   |
|--------|---|
| 388884 | AM6 démarrage par démarreur                             |
| 388870 | AM6   XP6   X-LIMIT démarrage par kick, non catalysé    |
| 388865 | DERBI SENDA   |
| 441469 | DERBI GPR50   GSM EURO 2 ->2006 démarrage par démarreur |
| 458153 | X-LIMIT   DT50 R 2003-> catalysé                        |
| 458154 | X-POWER   TZR 50 2003-> catalysé                        |







Sélection  
**CGN**

## ALLUMAGE OEM

**497489** DERBI SENDA EURO 3 volant magnétique complet pour moteur sans démarreur électrique



## MVT

### STATOR

**482095** Premium tous modèles



## MVT

### BOBINE

**388899** pour allumage MVT et DOPPLER



## MVT

### CALCULATEUR DIGIMAX

**441477** SENDA | GPR50 | GSM pour allumage MILLENIUM

**441474** moteur DERBI 6V

Digimax 5



## MVT

### DIAGRAMME MILLENIUM

**465612** MINARELLI 6V non catalysé

Di 07

**465611** SENDA | GPR | GSM EXT 111 | 115

DI 06



## STATOR TYPE ORIGINE

**468131** AM6 court DUCATI 311013-3110

**468130** AM6 long DUCATI 311013-31102

**468128** SENDA 85W DUCATI 531734380

**468129** GPR DERBI



468130



468129



## STATOR

**482616** AM6 2007-> avec capteur DUCATTI

**480351** AM6 | DERBI SENDA 60W avec capteur DUCATTI

**480404** AM6 | DERBI SENDA | GPR 80W avec capteur DUCATTI



482616

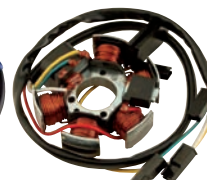

480351



480404



**MVT**

## ALLUMAGE PREMIUM AVEC ÉCLAIRAGE

|        |                         |           |
|--------|-------------------------|-----------|
| 468787 | 103 électronique 6V/12V | Premium 3 |
| 468788 | MBK 51                  | Premium 1 |



**MVT**

## ALLUMAGE MILLENIUM AVEC ÉCLAIRAGE

|        |   |
|--------|---|
| 388664 | 103 SP   MVL 6V ->2000 cône rupteur             |
| 388683 | 103 SPX   RCX   MVL 12V 2000-> CDI bleu         |
| 388679 | 103 SPX   RCX   MVL 6V ->2000 cône électronique |
| 388650 | MBK 51 démarrage à kick                         |
| 388645 | MBK 51 démarrage à pédales                      |



**MVT**

## ALLUMAGE DIGITAL DIRECT AVEC ÉCLAIRAGE\*

|        |        |
|--------|--------|
| 478468 | MBK 51 |
|--------|--------|



**MVT**

## DIAGRAMME MILLENIUM

|        |                                 |       |
|--------|---------------------------------|-------|
| 465606 | 51                              | DI 01 |
| 465608 | SP   MVL   SPX-RCX   FOX   FXR  | DI 03 |
| 465607 | DAKOTA   KANSAS   MBK PHENIX 20 | DI 02 |



**MVT**

## BOÎTIER MULTICOURBE COMPLET

|        |   |         |
|--------|---|---------|
| 476427 | transformateur analogique en digital pour Premium 1/9 12/11 | EPROM 1 |
| 482097 | transformateur analogique en digital pour Premium 2/3/8     | EPROM 2 |

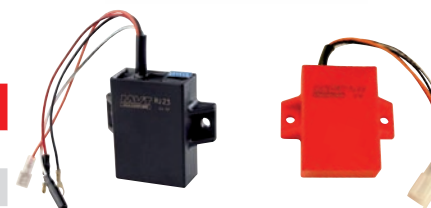

476427

482097



## ALLUMAGE

|        |  |
|--------|--|
| 483088 | 103 électronique 12V gros cône rupteur           |
| 467730 | 103 électronique 12V petit cône, cône électrique |
| 467731 | MBK 51/88 électronique 12V                       |



467730

467731



## STATOR

472544 103 électronique avec capteur sans plaque

480394 103 électronique avec plaque et capteur

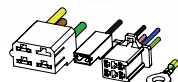

472544

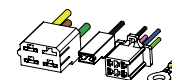
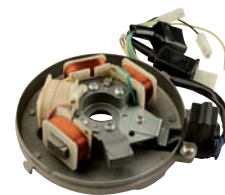

480394



## CAPTEUR CDI

614 103



## BOBINE

483517 éclairage 101 | 102 | 103 MVL | SP rupteur 15W

483518 éclairage 103 | VOGUE 10W stator étoile

1807 haute tension intérieure 103 MVL | SP réf origine 053336

189114 haute tension intérieure 103 allumage électronique

488669 basse tension intérieure AV88 | AV10 | 40 | 50 | 41 | 51

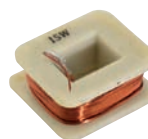

483517



483518



1807



189114



488669



## CONDENSATEUR

605 103 à visser

606 103 étoile

3992 MBK 51

3184 CIAO PX

485689 VESPA 50 réf origine 078937

485690 VESPA 50 réf origine 079697

494388 MBK 88/41 AV7/AV10



605



606



3992



3184



485689



485690



494388



Sélection  
**CGN**

## RUPTEUR

|               |                                     |
|---------------|-------------------------------------|
| <b>479417</b> | 103 inversé                         |
| <b>604</b>    | 103   102   101                     |
| <b>3988</b>   | MBK 51                              |
| <b>178823</b> | MBK inversé                         |
| <b>3183</b>   | CIAO PX                             |
| <b>494387</b> | origine NOVI MBK 88   41 AV7   AV10 |

## ALLUMAGE / IGNITION



479417



604



3988



178823



3183



494387



## RUPTEUR

**485691** VESPA 50/125 réf origine 101761



## RÉGULATEUR DE TENSION



**467040**

BOOSTER | NITRO 2004-> | BETA



**478413**

BOOSTER | BW'S | NITRO | AEROX



**477420**

LUDIX | KYMCO | SYM | V CLIC



**487832**

OVETTO | NEOS | NITRO | AEROX 4 temps



**450776**

TYPHOON ->1997 | NRG ->1998



**482114**

ZIP 4 temps | LX | LIBERTY | FLY



**485915**

CPI | KEEWAY



**484666**

AGILITY | SUPER 8 4 temps



**485692**

50 | 125 VESPA



**484668**

SENDA DERBI type FACOMSA ->2004



**482116**

SENDA DERBI DUCATI ->2008



**482115**

SENDA DERBI LEONELLI ->2008



**467789**

X-LIMIT | DT50 | X-POWER | TZR

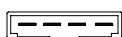

**480413**

103 PGT 12V



**485346**

103 6V lettre G



**276981**

51 MBK 12V 2 fils





## RÉGULATEUR DE TENSION

- 484667** SENDA DERBI type GUILERA 2 temps
- 494761** BOOSTER | BW'S | NITRO | AEROX
- 494762** BOOSTER | NITRO 2004->



484667



494761



494762



## RÉGULATEUR DE TENSION

- 482638** ZIP | TYPHOON 1999-> | NRG 1999->



## RÉGULATEUR DE TENSION

- 487058** RIEJU RMX | SMX 2009->
- 486298** RMX | RR | RS2 | SMX | SPIKE -->2002
- 486297** RMX | RR | RS2 | SMX | SPIKE 2003->
- 482138** SENDA DERBI 2009-> | RS4 | GPR
- 494173** DERBI SENDA DERBI 2004-> noir
- 491487** DERBI SENDA DERBI 2009-> | GSM | RS4
- 494368** DERBI SENDA DERBI 2009-> | GSM | RS4



487058

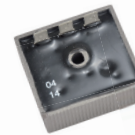

486298



486297



482138



494173



491487



494368



## BOBINE HAUTE TENSION EXTÉRIEUR

- 207733** BOOSTER | BW'S | NITRO | AEROX
- 450771** BOOSTER | NITRO | SR50 | F12
- 466788** CPI | KEEWAY
- 467786** BOOSTER | NITRO | SR50 | F12
- 1806** 101 | 102 | 103 MVL | SP rupteur
- 270285** MBK 51 électronique
- 4000** MBK 51 rupteur
- 451408** MBK type novi rupteur
- 168386** PEUGEOT tous modèles | X9 | X8



207733



450771



466788



467786



1806



270285



4000



451408



168386



## BOBINE CDI HAUTE TENSION

|        |   |
|--------|---|
| 450446 | AM6   DERBI ->2002 type DUCATI            |
| 483639 | DERBI type LEONELLI                       |
| 478411 | PIAGGIO TYPHOON   STALKER ->2000          |
| 478410 | TYPHOON ->1999   APRILIA ->2002           |
| 467424 | TYPHOON ->1999   VESPA LX   ZIP   STALKER |
| 440149 | TYPHOON 1999->   APRILIA ->2002           |
| 487001 | PIAGGIO 4 temps 50cc                      |
| 485685 | VESPA 50   125 PX                         |



## BOBINE CDI HAUTE TENSION

|        |                                 |
|--------|---------------------------------|
| 460531 | AM6 15000 tours allumage DUCATI |
| 494593 | AM6 origine allumage DUCATI     |

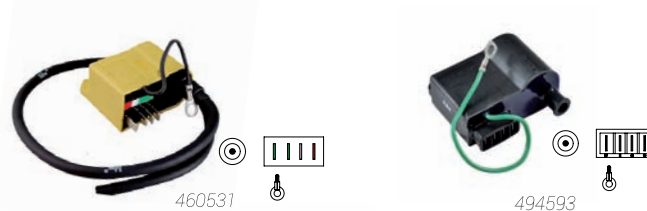

## BLOC CDI

|        |   |
|--------|---|
| 477445 | BOOSTER 2004->   NITRO   STUNT   OVETTO 2004->              |
| 207748 | BOOSTER   BW'S ->2004                                       |
| 477435 | BOOSTER   BW'S ->2003                                       |
| 482615 | type DELLORTO LUDIX   VIVACITY 3 UCE avant gauche           |
| 612    | avec capteur PEUGEOT 103   TREKKER   SPEEDFIGHT             |
| 441296 | bleu SPEEDFIGHT   TREKKER   BUXY   FOX 103 sans capteur 12V |
| 475870 | CPI   KEEWAY OLIVER   HUSSARD   F-ACT   MATRIX              |
| 479210 | SCOOTER CHINOIS 50 139QMB 4 temps   V-CLIC                  |
| 485996 | 50 CHINOIS   139QMB   GY6   4 temps                         |
| 485997 | BAOTIAN 50  |
| 485998 | BAOTIAN 50 avancé variable                                  |
| 490080 | CPI SM   SX   |
| 283664 | 51 MBK électronique   |
| 497119 | KYMCO 50 4 temps AGILITY R10   R12   ONE                    |
| 494808 | SPEEDFIGHT   VIVACITY 3 et 4   KISBEE   DJANGO              |

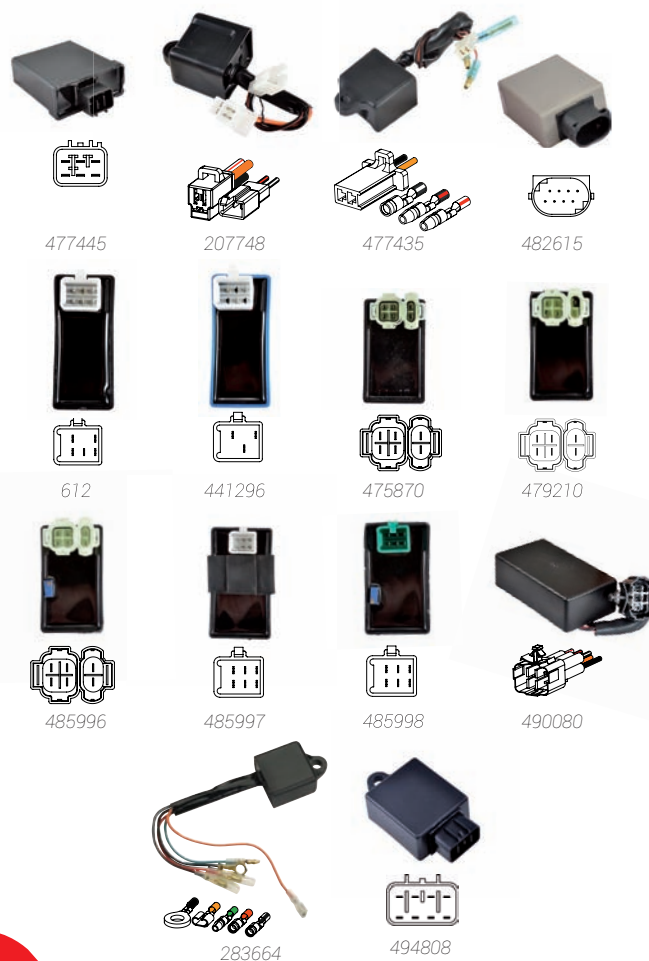



## DELEORTO

### BOBINE CDI

480447 LUDIX | VIVACITY 3 UCE avec gestion pompe à huile

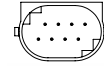

### BOBINE CDI

- 488116 VESPA 50 PK
- 467226 BOOSTER | NITRO avance fixe
- 460571 BOOSTER | BW'S | NITRO | AEROX avance variable
- 467787 BOOSTER | NITRO | SR50 | F12 monté origine

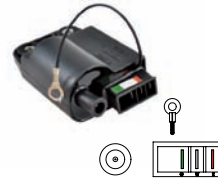

488116

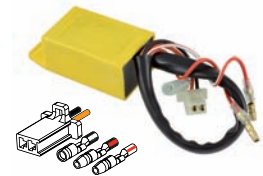

467226

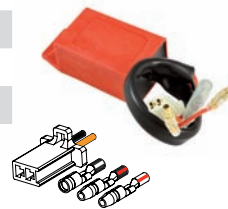

460571

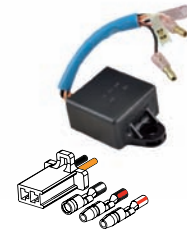

467787



### ÉCROU VARIATEUR, ALLUMAGE

461205 BOOSTER | BW'S | NITRO | AEROX | OVETTO | NEOS | SLIDER avec rondelle M10x1.25



### ÉCROU ALLUMAGE

- 484557 AM6 M10 X 1.25 M10x1.25
- 484558 SENDA | DERBI EURO 2 et 3 M10x100
- 484556 MVL | VOGUE | SP | SPX | RCX M10 X 100 M10x100
- 489602 MBK pas à droite (kick) M11X100



484557



484558



484556



489602



### CLAVETTE ALLUMAGE (X5)

460627 AM6 type origine

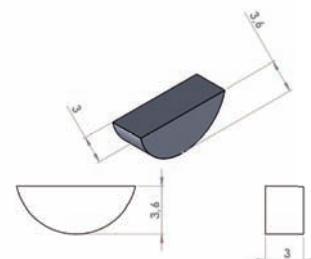



Sélection  
**CGN**

## CLAVETTE ALLUMAGE (X5)

- 484299** BOOSTER | STUNT | NITRO | TYPHOON | ZIP | STALKER
- 482377** 103 | VOGUE | FOX | SPX | VIVACITY | TKR | SPEEDFIGHT | KISBEE | VIVACITY
- 3187** CIAO PX
- 484300** DERBI SENDA EURO 2 et 3, 2.5x3.7mm

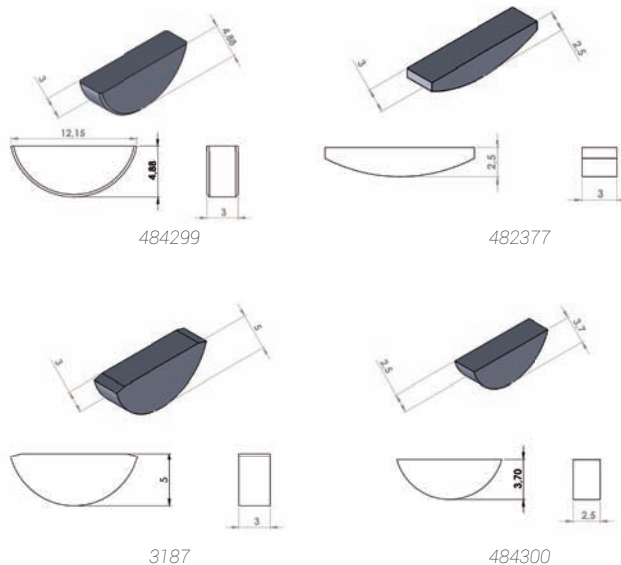

**TEKNIX**  
Original Quality Controller

## FIL DE BOUGIE

- 3996** MBK 51 court



Sélection  
**CGN**

## FIL DE BOUGIE 5M

- 1910** Ø5mm noir
- 491478** Ø5mm transparent
- 169000** Ø7mm noir



Sélection  
**CGN**

## TRESSE DE MASSE

- 3998** 51, longueur 300mm



Sélection  
**CGN**

## CACHE VOLANT NOIR LIVRÉ AVEC DEUX ATTACHES

- 478783** 103 PEUGEOT allumage électronique
- 478782** magnétique pour allumage rupteur NOVI MBK
- 494094** MBK 51 AV10 490510
- 497048** magnétique pour allumage rupteur MBK chrome



478782



494094

Sélection  
**CGN**

## BRIDE, SANGLE CACHE VOLANT

- 608** 103 MVL | VOGUE | SPX | RCX |
- 4011** MBK 51







## DÉMARREUR

|        |   |
|--------|---|
| 264522 | BOOSTER   BW'S   STUNT   SLIDER   OVETTO   NEOS       |
| 451378 | SPEEDFIGHT   TKR   VIVACITY   TYPHOON   ZIP   KISBEE  |
| 451379 | BUXY   SPEEDAKE   ZENITH                              |
| 478414 | OVETTO   NEOS   BOOSTER X   BOX X   AEROX 4 temps     |
| 479328 | CPI 50   KEEWAY 50                                    |
| 466793 | SCOOTER CHINOIS 50CC   V CLIC   AGILITY   139         |
| 478415 | SYM   KYMCO 50 AGILITY   DINK   PEOPLE                |
| 478426 | SYM 50   VIVACITY 3   SPEEDFIGHT 3 et 4   LUDIX       |
| 467781 | AM6   CPI   GENERIC   KSR   TZR   X-POWER   XPS   XP6 |
| 481749 | ZIP   TYPHOON   STALKER   NRG   FLY   LYBERTY         |

# ALLUMAGE / IGNITION

# MOTEUR



264522



478415



467781



481749



## DÉMARREUR

|        |                              |
|--------|------------------------------|
| 450767 | SPEEDFIGHT   TREKKER   LUDIX |
|--------|------------------------------|



## PIGNON LANCEUR DÉMARREUR

|        |                                   |
|--------|-----------------------------------|
| 482117 | SCOOTER CHINOIS 139 QMB   AGILITY |
| 489496 | SR 2004->   LIBERTY   TYPHOON     |
| 489497 | PIAGGIO 4 temps   GPR             |



## CENTRALE CLIGNOTANT

|        |   |
|--------|---|
| 486295 | RS2   NKD   MATRIX   MRX   SMX   RR   SPIKE |
| 486296 | TZR   X POWER 2004->                        |
| 479345 | OVETTO   NITRO   BOOSTER 2004->   RIEJU     |

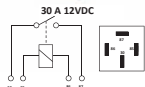

486295

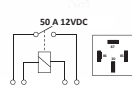

486296

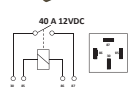

479345



## CENTRALE CLIGNOTANT

|        |   |
|--------|---|
| 207752 | BOOSTER ->2003   TMAX500   F12   MAJESTY          |
| 450782 | PIAGGIO 50   125                                  |
| 450780 | PEUGEOT tous modèles   SR50   F10   X8R   ADDRESS |
| 484655 | tous modèles 4 temps 12V 100AH                    |



207752

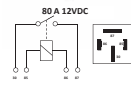

450782



450780



484655



## LIMITEUR RÉGIME MOTEUR

|        |           |
|--------|-----------|
| 481855 | universel |
|--------|-----------|



## BATTERIE 12V CLASSICS

## SLA

| Modèle   | FULBAT | YUASA | Longueur | Largeur | Hauteur |  | Livraison avec acide | Ampères (AH) | Polarité            |
|----------|--------|-------|----------|---------|---------|--|----------------------|--------------|---------------------|
| SLA 12-4 | 489939 |       | 110      | 68      | 89      |  | non GEL              | 4            | [-][ ][ ][ ][ ][ ]+ |

## YT

| Modèle      | FULBAT | YUASA  | Longueur | Largeur | Hauteur |                | Livraison avec acide | Ampères (AH) | Polarité          |
|-------------|--------|--------|----------|---------|---------|----------------|----------------------|--------------|-------------------|
| YT4B-BS     | 494764 |        | 114      | 39      | 86      | sans entretien | oui                  | 2.3          | [-][ ][ ][ ][ ]+  |
| YT7B-4 (BS) | 491434 |        | 150      | 65      | 93      | sans entretien | non                  | 6.5          | +[ ][ ][ ][ ][ ]- |
| YT7B-BS     |        | 488128 | 150      | 65      | 93      |                | oui                  | 6.5          | +[ ][ ][ ][ ][ ]- |
| YT9B-4 (BS) | 490564 |        | 150      | 68      | 105     | sans entretien | non GEL              | 8            | +[ ][ ][ ][ ][ ]- |
| YT12A-BS    | 490561 |        | 150      | 88      | 105     | sans entretien | oui                  | 10           | +[ ][ ][ ][ ][ ]- |
|             |        | 481623 | 150      | 87      | 105     |                | oui                  | 10           | +[ ][ ][ ][ ][ ]- |
| YT12B-BS    |        | 472408 | 150      | 69      | 130     | sans entretien | non                  | 10           | +[ ][ ][ ][ ][ ]- |
| YT12B-4     | 493803 |        | 150      | 69      | 130     | sans entretien | non GEL              | 10           | +[ ][ ][ ][ ][ ]- |
| YT14B-4     | 493804 |        | 150      | 69      | 145     | sans entretien | non GEL              | 12           | +[ ][ ][ ][ ][ ]- |

## YTR

| Modèle   | FULBAT | YUASA | Longueur | Largeur | Hauteur |                | Livraison avec acide | Ampères (AH) | Polarité            |
|----------|--------|-------|----------|---------|---------|----------------|----------------------|--------------|---------------------|
| YTR4A-BS | 490563 |       | 114      | 49      | 86      | sans entretien | oui                  | 2.3          | [-][ ][ ][ ][ ][ ]+ |

## YTX

| Modèle    | FULBAT | YUASA  | Longueur | Largeur | Hauteur |                             | Livraison avec acide | Ampères (AH) | Polarité            |
|-----------|--------|--------|----------|---------|---------|-----------------------------|----------------------|--------------|---------------------|
| YTX4L-BS  | 489937 | 465833 | 114      | 71      | 86      | sans entretien              | oui                  | 3            | [-][ ][ ][ ][ ][ ]+ |
|           | 489947 |        | 114      | 71      | 86      | surpuissante sans entretien | oui                  | 5            | [-][ ][ ][ ][ ][ ]+ |
| YTX5L-BS  | 489944 | 465835 | 114      | 71      | 106     | sans entretien              | oui                  | 4            | [-][ ][ ][ ][ ][ ]+ |
| YTX7A-BS  | 489941 | 465834 | 148      | 84      | 92      | sans entretien              | oui                  | 6            | +[ ][ ][ ][ ][ ]-   |
| YTX7L-BS  | 489942 | 465840 | 114      | 71      | 131     | sans entretien              | oui                  | 6            | [-][ ][ ][ ][ ][ ]+ |
| YTX9-BS   | 489940 |        | 152      | 88      | 106     | sans entretien              | oui                  | 8            | +[ ][ ][ ][ ][ ]-   |
|           |        | 465836 | 150      | 87      | 105     |                             | oui                  | 8            | +[ ][ ][ ][ ][ ]-   |
| YTX12-BS  | 489943 | 465837 | 152      | 88      | 131     | sans entretien              | oui                  | 10           | +[ ][ ][ ][ ][ ]-   |
| YTX14-BS  | 489946 | 465838 | 148      | 84      | 147     | sans entretien              | oui                  | 12           | +[ ][ ][ ][ ][ ]-   |
| YTX16-BS  | 490560 | 478136 | 150      | 87      | 161     | sans entretien              | oui                  | 14           | +[ ][ ][ ][ ][ ]-   |
| YTX20L-BS | 489948 |        | 172      | 84      | 164     | sans entretien              | oui                  | 18           | [-][ ][ ][ ][ ][ ]+ |

## BATTERIE 12V CLASSICS

| YTZ    |        |        |          |         |         |                |                      |              |           |
|--------|--------|--------|----------|---------|---------|----------------|----------------------|--------------|-----------|
| Modèle | FULBAT | YUASA  | Longueur | Largeur | Hauteur |                | Livraison avec acide | Ampères (AH) | Polarité  |
| YTZS   | 497360 |        | 113      | 70      | 85      |                |                      |              | - _ _ _ + |
| YTZ5S  | 497360 |        | 113      | 70      | 85      | sans entretien | non GEL              | 4            | - _ _ _ + |
| YTZ7S  | 493802 | 483662 | 113      | 70      | 105     | sans entretien | non GEL              | 6            | - _ _ _ + |
| YTZ10S | 490331 |        | 150      | 88      | 93      | sans entretien | non GEL              | 6            | + _ _ _ - |
|        |        | 483849 | 150      | 87      | 93      | sans entretien | non GEL              | 6            | + _ _ _ - |
| YTZ12S | 490330 |        | 150      | 88      | 110     | sans entretien | non GEL              | 11           | + _ _ _ - |
|        |        | 490511 | 150      | 87      | 110     | sans entretien | non GEL              | 11           | + _ _ _ - |
| YTZ14S | 490556 |        | 150      | 88      | 110     | sans entretien | non GEL              | 11           | + _ _ _ - |
|        |        | 490512 | 150      | 87      | 110     | sans entretien | non GEL              | 11           | + _ _ _ - |

| YB        |        |        |          |         |         |                      |              |           |  |
|-----------|--------|--------|----------|---------|---------|----------------------|--------------|-----------|--|
| Modèle    | FULBAT | YUASA  | Longueur | Largeur | Hauteur | Livraison avec acide | Ampères (AH) | Polarité  |  |
| YB3L-A    | 489945 |        | 95       | 54      | 110     | oui                  | 3            | - _ _ _ + |  |
|           |        | 465832 | 98       | 56      | 110     | non                  | 3            | - _ _ _ + |  |
| YB3L-B    | 490557 |        | 95       | 54      | 110     | non                  | 3            | - _ _ _ + |  |
|           |        | 467892 | 98       | 56      | 110     | non                  | 3            | - _ _ _ + |  |
| YB4L-B    |        | 462567 | 120      | 70      | 92      | non                  | 4            | - _ _ _ + |  |
|           |        | 483973 | 120      | 70      | 92      | oui                  | 4            | - _ _ _ + |  |
|           | 489936 |        | 121      | 71      | 93      | non                  | 4            | - _ _ _ + |  |
|           | 489949 |        | 121      | 71      | 93      | oui                  | 4            | - _ _ _ + |  |
| YB5L-B    | 489935 |        | 121      | 91      | 131     | oui                  | 5            | - _ _ _ + |  |
|           |        | 462568 | 120      | 60      | 130     | non                  | 5            | - _ _ _ + |  |
| YB7-A     | 493812 |        | 135      | 75      | 133     | oui                  | 8            | + _ _ _ - |  |
|           |        | 462571 | 133      | 74      | 132     | non                  | 8            | + _ _ _ - |  |
| YB7L-B2   | 490559 |        | 135      | 75      | 133     | oui                  | 8            | - _ _ _ + |  |
|           |        | 462572 | 135      | 75      | 133     | non                  | 8            | - _ _ _ + |  |
| YB9-B     | 489938 |        | 137      | 76      | 140     | oui                  | 9            | - _ _ _ + |  |
|           |        | 462573 | 137      | 76      | 140     | non                  | 9            | - _ _ _ + |  |
| YB10L-BP  | 493813 |        | 135      | 90      | 145     | oui                  | 11           | - _ _ _ + |  |
|           |        | 465841 | 135      | 90      | 145     | non                  | 12           | - _ _ _ + |  |
| YB10L-B2  | 497358 |        | 135      | 90      | 154     | non                  | 11           | - _ _ _ + |  |
|           |        | 467893 | 135      | 90      | 145     | non                  | 11           | - _ _ _ + |  |
| YB12AL-A  | 497359 | 467894 | 131      | 77      | 160     | non                  | 12           | - _ _ _ + |  |
| YB12AL-A2 | 491025 |        | 132      | 77      | 160     | oui                  | 12           | - _ _ _ + |  |
|           |        | 462574 | 132      | 77      | 160     | non                  | 12           | - _ _ _ + |  |
| YB14L-A2  | 490558 |        | 134      | 89      | 166     | oui                  | 14           | - _ _ _ + |  |
|           |        | 465842 | 134      | 89      | 166     | non                  | 14           | - _ _ _ + |  |

## BATTERIE 12V CLASSICS

## AUTRES

| Modèle     | FULBAT | YUASA  | Longueur | Largeur | Hauteur |                | Livraison avec acide | Ampères (AH) | Volts (V) | Polarité |
|------------|--------|--------|----------|---------|---------|----------------|----------------------|--------------|-----------|----------|
| 6N4-2A     | 491024 |        | 70       | 70      | 94      |                | oui                  | 4            | 6         |          |
| 12N7-3B    |        | 472409 | 135      | 75      | 134     |                | non                  | 7            | 12        |          |
| FCP18-12   | 493806 |        | 182      | 77      | 168     | sans entretien | non GEL              | 18           | 12        |          |
| YHD14HL-BS | 493807 |        | 150      | 87      | 145     | sans entretien | non GEL              | 14           | 12        |          |
| YHD20HL-BS | 493808 |        | 175      | 87      | 155     | sans entretien | non GEL              | 20           | 12        |          |
| 12N5.5-3B  | 493810 |        | 135      | 60      | 130     |                | oui                  | 5.5          | 12        |          |
| 12N5.5-4A  | 493811 |        | 135      | 60      | 130     |                | oui                  | 5.5          | 12        |          |
| 53030      | 493814 |        | 186      | 130     | 171     |                | oui                  | 30           | 12        |          |

## MOTOCULTURE

| Modèle    | FULBAT | YUASA | Longueur | Largeur | Hauteur |                | Ampères (AH) |
|-----------|--------|-------|----------|---------|---------|----------------|--------------|
| U1-9      | 492329 |       | 195      | 130     | 180     | sans entretien | 28           |
| U1R-9     | 492330 |       | 195      | 130     | 180     | sans entretien | 28           |
| SLA 12-18 | 492331 |       | 182      | 77      | 68      | sans entretien | 18           |
| SLA 12-20 | 492332 |       | 182      | 177     | 168     | sans entretien | 20           |

BATTERIE / BATTERIE

CHARGEUR DE BATTERIE



CHARGEUR DE BATTERIE FULLLOAD 750

497058 | 6V/12V | 0.75A | pour batterie de 2A à 20A

- ↳ Chargeur mainteneur intelligent
- ↳ 3 phases: charge principale, charge de maintien, charge de maintien à long terme
- ↳ Pour toutes batteries: GEL, SLA, MF et DRY
- ↳ Idéal pour la maintenance à long-terme
- ↳ Sûr et facile d'utilisation
- ↳ Ne surcharge jamais la batterie
- ↳ Protection interne contre la surchauffe et la surcharge
- ↳ Livré avec des pinces et un kit de connexion protégé par fusible



CHARGEUR DE BATTERIE FULLLOAD 1000

489933 | 6V/12V | 1A | pour batterie de 2A à 20A

- ↳ Chargeur mainteneur intelligent
- ↳ 3 phases: charge principale, charge de maintien, charge de maintien à long terme
- ↳ Pour toutes batteries: GEL, SLA, MF et DRY
- ↳ Idéal pour la maintenance à long-terme
- ↳ Sûr et facile d'utilisation
- ↳ Ne surcharge jamais la batterie
- ↳ Protection interne contre la surchauffe et la surcharge
- ↳ Livré avec des pinces et un kit de connexion protégé par fusible



CHARGEUR DE BATTERIE FULLLOAD 1500

487732 | 12V | 1.5A | pour batterie de 2A à 30A

- ↳ Chargeur intelligent avec fonction de réjuvenation
- ↳ 8 phases
- ↳ Idéal pour la maintenance à long-terme
- ↳ Sûr et facile d'utilisation
- ↳ Ne surcharge jamais la batterie
- ↳ Protection interne contre la surchauffe et la surcharge
- ↳ Livré avec des pinces et un kit de connexion protégé par fusible



CHARGEUR DE BATTERIE FULBANK 1500

493815 | 12V | 1.5A | pour batterie de 2A à 30A

- ↳ Chargeur intelligent à 5 entrées avec fonction de réjuvenation
- ↳ 8 phases
- ↳ Idéal pour la maintenance à long-terme
- ↳ Sûr et facile d'utilisation
- ↳ Ne surcharge jamais la batterie
- ↳ Protection interne contre la surchauffe et la surcharge
- ↳ Livré avec des pinces et un kit de connexion protégé par fusible



CHARGEUR DE BATTERIE

461203 | 12V | 0.3A | 3.6W



## TESTEUR DE BATTERIE



### TESTEUR DE BATTERIE FULTEST

489934 12V 0.3A 3.6W

- ↳ Teste l'état de la batterie et de l'alternateur
- ↳ Contrôle la capacité du véhicule à démarrer
- ↳ Vérifie et analyse l'état de charge de la batterie
- ↳ Confirme la bonne marche de l'alternateur
- ↳ Facile d'utilisation
- ↳ Résistant à l'eau
- ↳ Diagnostic immédiat



## BATTERIE / BATTERIE

## ACCESSOIRE



### AIDE AU DÉMARRAGE FULBOOST

497057

- ↳ Capacité: 15000mAh
- ↳ Courant en crête: 600A
- ↳ Courant de démarrage: 300A
- ↳ FULBOOST est un booster pour les véhicules qui sont équipés d'une batterie 12 V WET, MF, SLA, GEL, Ca/Ca, AGM ou EFB
- ↳ Il peut démarrer des moteurs allant jusqu'à 5.0L essence et 3.0L Diesel
- ↳ C'est également un chargeur puissant pour tout types d'applications électriques: GPS, tablette, appareil photo...
- ↳ C'est enfin une lampe torche LED très puissante qui fonctionne avec trois modes
- ↳ La technologie Smart Cable protège la batterie et l'électronique embarqué
- ↳ Il est équipé de la technologie anti-étincelle, d'une protection contre le court-circuit et d'une protection contre l'inversion de polarité
- ↳ Son inclus: une valise de protection, un Smart Cable, un câble USB multi-adaptateurs, une prise allume-cigare, un chargeur domestique 12V et 8 adaptateurs pour chargeur PC



### ACIDE DE BATTERIE

162297 1L



### PILE LITHIUM

|        |        |    |     |
|--------|--------|----|-----|
| 488539 | CR1616 | 3V | x1  |
| 227580 | CR1620 | 3V | x1  |
| 497357 | CR2    | 3V | x1  |
| 263822 | CR2016 | 3V | x1  |
| 382283 | CR2025 | 3V | x1  |
| 176649 | CR2032 | 3V | x1  |
| 492584 | CR2032 | 3V | x1  |
| 492585 | CR2032 | 3V | x20 |
| 227594 | CR2320 | 3V | x1  |
| 473119 | CR2450 | 3V | x1  |



### PILE ALCALINE

|        |             |      |    |
|--------|-------------|------|----|
| 479093 | CR2430      | 3V   | x1 |
| 476149 | LR03 NX AAA | 1.5V | x2 |
| 476148 | LR06 AA     | 1.5V | x4 |
| 7794   | LR12        | 4.5V | x1 |
| 7799   | LR14        | 1.5V | x2 |
| 188562 | LR20        | 1.5V | x2 |
| 479092 | LR23        | 12V  | x1 |
| 492073 | LR27A       | 12V  | x1 |
| 465672 | LR43        | 1.5V | x2 |
| 466058 | LR44        | 1.5V | x2 |
| 491244 | LR61        | 9V   | x1 |



### PILE SALINE

|        |      |      |    |
|--------|------|------|----|
| 476150 | 3R12 | 4.5V | x1 |
|--------|------|------|----|

## BOUGIE STANDARD

**INFO + :**

Retrouvez les affectations des bougies dans le catalogue NGK.

## Repères Bougies d'allumage

La désignation du type standard est indiquée ici. Il existe par ailleurs quelques autres désignations particulières.

| Diamètre de filetage / Hexagone |              | Structure |   | Résistance antiparasitage |                     | Indice thermique |                          |
|---------------------------------|--------------|-----------|---|---------------------------|---------------------|------------------|--------------------------|
| <b>A</b>                        | 18 mm / 25,4 | <b>P</b>  | Isolant proéminent                                    | <b>R</b>                  | Résistance          | <b>2</b>         | Type chaud<br>Type froid |
| <b>B</b>                        | 14 mm / 20,8 | <b>M</b>  | Bougie compacte                                       | <b>Z</b>                  | Inductance intégrée | <b>4</b>         |                          |
| <b>C</b>                        | 10 mm / 16,0 | <b>U</b>  | Décharge superficielle ou à étincelle semi-surfacique |                           |                     | <b>5</b>         |                          |
| <b>D</b>                        | 12 mm / 18,0 |           |   |                           |                     | <b>6</b>         |                          |
| <b>E</b>                        | 8 mm / 13,0  |           |   |                           |                     | <b>7</b>         |                          |
| <b>AB</b>                       | 18 mm / 20,8 |           |   |                           |                     | <b>8</b>         |                          |
| <b>BC</b>                       | 14 mm / 16,0 |           |   |                           |                     | <b>9</b>         |                          |
| <b>BK</b>                       | 14 mm / 16,0 |           |   |                           |                     | <b>10</b>        |                          |
| <b>DC</b>                       | 12 mm / 16,0 |           |   |                           |                     |                  |                          |

**B P R 5 E S - 11**

| Longueur du filetage |   | Caractéristiques de conception |  | Ecartement |  |
|----------------------|---|--------------------------------|--|------------|--|
| <b>E</b>             | 19,0 mm   | <b>B</b>                       | Olive SAE monbloque (CR8EB)  | vide       | Moto : 0.7-0.8 mm, Automobile : 0.8-0.9 mm |
| <b>EH</b>            | 19,0 mm, semi-filetage<br>Culot 19 mm Filetage 12,7                               | <b>CM</b>                      | Electrode de masse oblique<br>Type compact (longueur isolant : 18.5 mm)    | -8         | 0,8 mm                                     |
| <b>H</b>             | 12,7 mm   | <b>CS</b>                      | Electrode de masse oblique<br>Type compact (longueur insulateur : 18.5 mm) | -9         | 0,9mm                                      |
| <b>L</b>             | 11,2 mm   | <b>G, GV</b>                   | Bougie d'allumage de course  | -10        | 1,0mm                                      |
| <b>F</b>             | Siège conique<br>A-F---10,9 mm<br>B-F---11,2 mm<br>B-EF--17,5 mm<br>BM-F --7,8 mm | <b>I</b>                       | Electrode Iridium  | -11        | 1,1mm                                      |
|                      |   | <b>IX</b>                      | Gamme Iridium IX   | -13        | 1,3mm                                      |
|                      |   | <b>J</b>                       | 2 électrodes de masse  | -14        | 1,4mm                                      |
|                      |   | <b>K</b>                       | 2 électrodes de masse à effet semi-surfacique                              | -15        | 1,5mm                                      |
|                      |   | <b>-L</b>                      | Semi indice thermique (+ chaud)  |            |  |
| vide                 | Bougie compacte<br>BM---9,5 mm<br>BPM--9,5 mm<br>CM---9,5 mm                      | <b>-LM</b>                     | Type compact (longueur isolant : 14,5 mm)                                  |            |  |
|                      |   | <b>N</b>                       | Electrode de masse spéciale  | -S         | Joint spécifique                           |
|                      |   | <b>P</b>                       | Electrode centrale en Platine  | -E         | Résistance spéciale                        |
|                      |   | <b>Q</b>                       | 4 électrodes de masse  |            |  |
|                      |   | <b>S</b>                       | Electrode centrale en cuivre   |            |  |
|                      |   | <b>T</b>                       | 3 électrodes de masse  |            |  |
|                      |   | <b>U</b>                       | à décharge semi-surfacique   |            |  |
|                      |   | <b>VX</b>                      | Electrode centrale en Platine  |            |  |
|                      |   | <b>Y</b>                       | Electrode centrale à gorge en V - Proéminence sup. à 1mm                   |            |  |
|                      |   | <b>Z</b>                       | Conception spéciale  |            |  |



## Repères Bougies d'allumage

La désignation du type standard est indiquée ici. Il existe par ailleurs quelques autres désignations particulières.

| Type  |   | Dimensions du filetage / Hexagone |       |         |               |             |
|---|---|-----------------------------------|-------|---------|---------------|-------------|
| <b>D</b>  | Haute capacité d'allumage : technologie DFE | KA                                | Ø12.0 | 19,0mm  | Joint         | 14,0        |
| <b>I</b>  | Bougie Iridium                              | KB                                | Ø12.0 | 19,0 mm | Joint         | Bi-Hex 14.0 |
| <b>L</b>  | Filetage extra-long de 26,5mm               | MA                                | Ø10.0 | 19,0 mm | Joint         | 14,0        |
| <b>P</b>  | Bougie Platine                              | NA                                | Ø12.0 | 17,5 mm | Siège conique | 14,0        |
| <b>S</b>  | Haute capacité d'allumage : insert platine  | F                                 | Ø14.0 | 19,0 mm | Joint         | 16,0        |
| <b>Z</b>  | Isolant proéminent                          | G                                 | Ø14.0 | 19,0 mm | Joint         | 20,8        |
| Les caractéristiques citées ci-dessus peuvent être combinées, par ex. ILFR..., PLZFR...<br>"L", pour filetage long, placé devant toutes les autres lettres de l'identification de longueur.<br>ex.<br>• Bougie avec joint d'étanchéité<br>FR5AP-11 ; longueur de filetage 19.0 mm<br>LFR5AP-11 ; longueur de filetage 26.5 mm<br>• Bougie à siège conique<br>PTR5C-13 ; longueur de filetage 17.5 mm<br>PLTR6A-10G ; longueur de filetage 25.0 mm |   | J                                 | Ø12.0 | 19,0 mm | Joint         | 18,0        |
|   |   | K                                 | Ø12.0 | 19,0 mm | Joint         | 16,0        |
|   |   | L                                 | Ø10.0 | 12,7 mm | Joint         | 16,0        |
|   |   | M                                 | Ø10.0 | 19,0 mm | Joint         | 16,0        |
|   |   | T                                 | Ø14.0 | 17,5 mm | Siège conique | 16,0        |
|   |   | U                                 | Ø14.0 | 11,2 mm | Siège conique | 16,0        |
|   |   | W                                 | Ø18.0 | 10,9 mm | Siège conique | 20,8        |
|   |   | X                                 | Ø14.0 | 9,5 mm  | Joint         | 20,8        |
|   |   | Y                                 | Ø14.0 | 11,2 mm | Siège conique | 16,0        |

P F R 5 A - 11

| Résistance antiparasitage |            | Indice thermique |            | Conception |                               | Distance entre les électrodes                |  |
|---------------------------|------------|------------------|------------|------------|-------------------------------|--|--|
| <b>R</b>                  | Résistance | 2                | Type chaud | A, B, C... | Caractéristique spéciales     | vide   | Moto : 0,7-0,8 mm<br>Automobile : 0,8-0,9 mm |
|                           |            | 4                |            |            |                               | - 7  | 0,7mm  |
|                           |            | 5                |            |            |                               | - 9  | 0,9mm  |
|                           |            | 6                |            | I          | Electrode centrale Iridium    | -10  | 1,0mm  |
|                           |            | 7                |            | P          | Electrode centrale en Platine | -11  | 1,1mm  |
|                           |            | 8                |            |            |                               | -13  | 1,3mm  |
|                           |            | 9                |            |            |                               | -14  | 1,4mm  |
|                           |            | 10               |            |            |                               | -15  | 1,5mm  |
|                           |            |                  |            |            |                               | -A   | Sans joint d'étanchéité                      |
|                           |            |                  |            |            |                               | -D   | Traitement surface spécial du culot          |
|                           |            |                  |            |            |                               | -E   | Résistance spéciale                          |
|                           |            |                  |            |            | -G                            | Electrode de masse à noyau en cuivre         |  |
|                           |            |                  |            |            | -H                            | Filetage spécial                             |  |
|                           |            |                  |            |            | -J                            | 2 électrodes de masse                        |  |
|                           |            |                  |            |            | -K                            | Electrode de masse résistante aux vibrations |  |
|                           |            |                  |            | -N         | Electrode de masse spéciale   |  |  |
|                           |            |                  |            | -Q         | 4 électrodes de masse         |  |  |
|                           |            |                  |            | -S         | Joint spécifique              |  |  |
|                           |            |                  |            | -T         | 3 électrodes de masse         |  |  |





# BOUGIE / SPARK PLUG

MOTEUR



## CULOT A (Ø FILETAGE 18MM, CLÉ 25,4)

1864 AB-6

## CULOT B (Ø FILETAGE 14MM, CLÉ 21)

|        |          | Nickel | Platinum |        |        |
|--------|----------|--------|----------|--------|--------|
| 487537 | B2LM     |        |          |        |        |
| 490451 | B4H      |        |          |        |        |
| 221892 | B4LM     |        |          |        |        |
| 1833   | B5HS     |        |          |        |        |
| 1841   | B6ES     |        |          |        |        |
| 1834   | B6HS     |        |          |        |        |
| 1866   | B6S      |        |          |        |        |
| 1842   | B7ES     |        |          |        |        |
| 1835   | B7HS     |        |          |        |        |
| 1843   | B8ES     | 198244 | B8EG     |        |        |
| 1837   | B8HS     |        |          |        |        |
| 1844   | B9ES     | 1869   | B9EG     | 214234 | B9EGV  |
| 1838   | B9HS     |        |          |        |        |
| 213879 | B10ES    | 1870   | B10EG    | 1874   | B10EGV |
| 213883 | B10HS    |        |          |        |        |
| 478787 | B11EGP   |        |          |        |        |
| 1875   | B11EGV   |        |          |        |        |
| 485574 | BCPR5ES  |        |          |        |        |
| 485575 | BCPR6ES  |        |          |        |        |
| 490452 | BKR5E    |        |          |        |        |
| 490454 | BKR6E    |        |          |        |        |
| 496386 | BKR6E-11 |        |          |        |        |
| 496385 | BKR7EKC  |        |          |        |        |
| 1877   | BM6A     |        |          |        |        |
| 1876   | BM6F     |        |          |        |        |
| 279737 | BM7A     |        |          |        |        |
| 1879   | BMR6A    |        |          |        |        |
| 490455 | BMR6F    |        |          |        |        |
| 485576 | BMR7A    |        |          |        |        |
| 490456 | BP5ES    |        |          |        |        |
| 490457 | BP6ES    |        |          |        |        |
| 490458 | BP6HS    |        |          |        |        |
| 490459 | BP7ES    |        |          |        |        |
| 490460 | BP7HS    |        |          |        |        |
| 490461 | BP8ES    |        |          |        |        |
| 490462 | BP8HS    |        |          |        |        |
| 1847   | BP9ES    |        |          |        |        |

|        |          | Nickel | Iridium |         |          |
|--------|----------|--------|---------|---------|----------|
| 1881   | BPM6A    |        |         |         |          |
| 279722 | BPM7A    |        |         |         |          |
| 1882   | BPMR6A   |        |         |         |          |
| 1880   | BPMR7A   |        |         |         |          |
| 486689 | BPMR8Y   |        |         |         |          |
| 214139 | BPR4HS   |        |         |         |          |
| 198191 | BPR5ES   |        |         |         |          |
| 497111 | BPR5HS   |        |         |         |          |
| 198187 | BPR6ES   |        |         |         |          |
| 1886   | BPR6HS   |        |         |         |          |
| 1885   | BPR6HSA  |        |         |         |          |
| 280134 | BPR6HVX  |        |         |         |          |
| 1848   | BPR7ES   |        |         |         |          |
| 1887   | BPR7HS   |        | 497112  | BPR7HIX |          |
| 280149 | BPR7HVX  |        |         |         |          |
| 496395 | BPR8ES   |        |         |         |          |
| 1888   | BPR8HS   |        |         |         |          |
| 485577 | BR2LM    |        |         |         |          |
| 490464 | BR4LM    |        |         |         |          |
| 490465 | BR5HS    |        |         |         |          |
| 487542 | BR6FS    |        |         |         |          |
| 198206 | BR6HS    | 490466 | BR6HSA  | 497114  | BR6HIX   |
| 490467 | BR6S     |        |         |         |          |
| 455372 | BR7ES    |        |         | 497115  | BR7EIX   |
| 172707 | BR7HS    |        |         | 497113  | BR7HIX   |
| 217305 | BR7HS-10 |        |         |         |          |
| 496394 | BR8ECM   |        |         |         |          |
| 1889   | BR8ES    | 214162 | BR8EG   | 381507  | BR8EIX   |
| 195431 | BR8HS    | 367128 | BR8HSA  | 381492  | BR8HIX   |
| 214181 | BR9ECM   |        |         | 496382  | BR9ECMIX |
| 214196 | BR9ECS   | 1892   | BR9EG   | 381511  | BR9EIX   |
| 1890   | BR9ES    |        |         | 381511  | BR9EIX   |
| 198217 | BR9HS    |        |         | 1851    | BR9HIX   |
| 467624 | BR10ES   | 198172 | BR10EG  | 381617  | BR10EIX  |
|        |          |        |         | 476353  | BR10HIX  |



**CULOT C (Ø FILETAGE 10MM, CLÉ 16)**

|        |          | Iridium |           |
|--------|----------|---------|-----------|
| 465600 | C7HSA    |         |           |
| 485968 | CMR6H    |         |           |
| 487540 | CMR7A    |         |           |
| 490468 | CMR7H    |         |           |
| 496389 | CPR7EA-9 |         |           |
| 336134 | CPR8E    |         |           |
| 496384 | CPR8EA-9 |         |           |
| 490493 | CPR8EB9  |         |           |
| 465889 | CPR9EA-9 |         |           |
| 213947 | CR10EK   |         |           |
| 374805 | CR5HSB   |         |           |
| 213898 | CR6HSA   |         |           |
| 213902 | CR7E     |         |           |
| 450804 | CR7EB    |         |           |
| 496392 | CR7EH-9  | 490469  | CR7EIX    |
| 462112 | CR7EKA   | 490469  | CR7EIX    |
| 450805 | CR7EKB   | 490469  | CR7EIX    |
| 1861   | CR7HSA   | 496398  | CR7HIX    |
| 1862   | CR8E     | 490470  | CR8EIX    |
| 384085 | CR8EB    | 490470  | CR8EIX    |
| 198263 | CR8EH9   | 496404  | CR8EHIX-9 |
| 461666 | CR8EK    |         |           |
| 496381 | CR8EKB   |         |           |
| 213917 | CR8HSA   |         |           |
| 1863   | CR9E     | 381550  | CR9EIX    |
| 328861 | CR9EB    | 381550  | CR9EIX    |
| 198278 | CR9EH9   | 496391  | CR9EHIX-9 |
| 496379 | CR9EIA-9 |         |           |
| 213936 | CR9EK    |         |           |
| 496397 | CR9EKB   |         |           |



**CULOT D (Ø FILETAGE 12MM, CLÉ 18)**

|        |           |
|--------|-----------|
| 1855   | D8EA      |
| 1856   | D8HA      |
| 214067 | D9EA      |
| 496387 | DCPR7E    |
| 496380 | DCPR8E    |
| 213989 | DCPR9E    |
| 214029 | DP8EA-9   |
| 490471 | DPR6EA9   |
| 198282 | DPR7EA9   |
| 1857   | DPR8EA9   |
| 496403 | DPR8EIX   |
| 496388 | DPR8EIX-9 |
| 496383 | DPR8EKC   |
| 1860   | DPR9EA9   |
| 496396 | DR7EA     |
| 198225 | DR8EA     |
| 493825 | DR8EIX    |
| 1858   | DR8ES     |
| 1859   | DR8ESL    |
| 214048 | DR9EA     |
| 497116 | LB05EPK   |
| 497117 | LB05FG    |
| 497118 | RC-X140   |



**CULOT I (Ø FILETAGE 10MM, CLÉ 16)**

|        |            |
|--------|------------|
| 496406 | IMR9C-9H   |
| 496407 | IMR9C-9HES |



**CULOT J (Ø FILETAGE 12MM, CLÉ 18)**

|        |      |
|--------|------|
| 1893   | JR9B |
| 496390 | JR9C |



**CULOT L (Ø FILETAGE 10MM, CLÉ 16)**

|        |          |
|--------|----------|
| 496405 | LMAR8A-9 |
| 496402 | LR8B     |



**CULOT M (Ø FILETAGE 10MM, CLÉ 16)**

|        |           |
|--------|-----------|
| 496393 | MAR8B-JDS |
|--------|-----------|



**CULOT P (Ø FILETAGE 10MM, CLÉ 16)**

|        |       |
|--------|-------|
| 490472 | PMR7A |
|--------|-------|



**CULOT R (Ø FILETAGE 14MM, CLÉ 21)**

|        |           |
|--------|-----------|
| 487805 | R016-10   |
| 166087 | R6252E105 |
| 1854   | R6254E105 |



**CULOT Z (Ø FILETAGE 10MM, CLÉ 16)**

|        |        |
|--------|--------|
| 490473 | ZMR7AP |
|--------|--------|

## ANTIPARASITE

## SIGNIFICATION DES RÉFÉRENCES

**L**

| Apparence |                      |
|-----------|----------------------|
| L         | Coude 90°            |
| S         | Droit                |
| X         | Coude à 102°         |
| V         | Coude à 120° (long)  |
| Y         | Coude à 120° (court) |
| T         | Type "T"             |

**B**

| Filetage bougie |                 |
|-----------------|-----------------|
| B               | Ø 14 mm         |
| C               | Ø 10 mm         |
| D               | Ø 10 & 12 mm    |
| Z               | Ø 10, 12, 14 mm |

**10**

| Résistance |       |
|------------|-------|
| Vide       | 0 kΩ  |
| 01         | 1 kΩ  |
| 05         | 5 kΩ  |
| 10         | 10 kΩ |

**E**

| Embout bougie |            |
|---------------|------------|
| E             | Avec olive |
| F             | Sans olive |

**H F**

| Apparence |                               |
|-----------|-------------------------------|
| A         | Design spécial                |
| F         | Pour câble HT Ø 5 mm          |
| G         | Avec joint pour volute moteur |
| H         | Type compact                  |
| K         | Joint silicone étanche        |
| L         | Résistance bobinée            |
| M         | Gaine caoutchouc              |
| P         | Joint spécial étanche         |
| S         | Blindé                        |
| Y         | Avec ergot de préhension      |
| Z         | Forme spéciale                |

## TECHNOLOGIES

Corps en phénol  
(Isolation optimum  
Meilleure longévité)

Connecteur bougie  
clip ou vis (Meilleur  
contact Connexion facile)

Joint caoutchouc  
(Meilleure étanchéité)



Connecteur bougie clip  
ou vis (Meilleur contact,  
Connexion facile)

Corps en phénol (Isolation -  
meilleure longévité)



Lèvres d'étanchéité évitent l'introduction d'eau  
en conditions extrêmes (Enduro, Cross, Endurance)

Vis de fixation du câble haute tension  
(Meilleure conductibilité)

Connecteur bougie clip ou vis  
(Meilleur contact - Connexion facile)

Résistance en céramique  
(Protection électrique  
optimum)

Corps en phénol  
(Isolation électrique optimum)



## ANTIPARASITE

## BOUGIE / SPARK PLUG

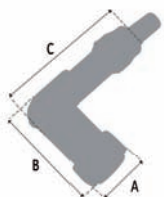

1802

A: 22mm | B: 41mm | C: 52mm  
LB05E



1805

A: 17mm | B: 47mm | C: 36mm  
LB05EMH (caoutchouc)



166637

A: 22mm | B: 41mm | C: 52mm  
LB05F



483627

A: 22mm | B: 41mm | C: 52mm  
LB10E



1804

A: 14mm  
LB10EH



1803

A: 22mm | B: 41mm | C: 52mm  
LB10F



490479

A: 22mm | B: 35mm | C: 34mm  
LZEH



490476

A: 22mm | B: 37mm | C: 35mm  
LZFH



481195

A: 24mm | B: 83mm | C: 35mm  
XD05F



214317

A: 24mm | B: 83mm | C: 35mm  
XD10F



490477

A: 24mm | B: 68mm | C: 46mm  
VB05E



490478

A: 24mm | B: 68mm | C: 46mm  
VB05F



214291

A: 24mm | B: 68mm | C: 46mm  
VB10F



214306

A: 24mm | B: 68mm | C: 46mm  
VD10F



214272

A: 24mm | B: 83mm  
SB10F



214287

A: 24mm | B: 83mm  
SD10F

BOUGIE / SPARK PLUG

ANTIPARASITE

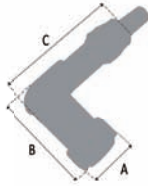

493932

A: 20mm | B: 36mm | C: 46mm  
caoutchouc souple noir



493933

A: 20mm | B: 36mm | C: 46mm  
caoutchouc souple rouge



496459

A: 20mm | B: 36mm | C: 46mm  
caoutchouc souple jaune fluo



496460

A: 20mm | B: 36mm | C: 46mm  
caoutchouc souple vert fluo



496461

A: 20mm | B: 36mm | C: 46mm  
caoutchouc souple orange fluo



479211

A: 21mm | B: 43mm | C: 75mm  
transparent rouge éclairant



484136

A: 50mm | B: 50mm | C: 37mm  
silicone étanche pour scooter  
Chinois 139QMB / KYMCO



281150

A: 18mm | B: 33mm | C: 55mm  
adaptable scooter MBK



603

A: 26mm | B: 58mm | C: 57mm  
adaptable 103 (électronique)



3995

A: 26mm | B: 58mm | C: 57mm  
adaptable MBK 51 (électronique)

ANTIPARASITE RACING



279767



A: 19mm | B: 49mm | C: 59mm |  
longueur 570mm  
CR4 coudé pour bougie avec olive  
(livré avec fil)



279354



A: 19mm | B: 49mm | C: 59mm |  
longueur 570mm  
CR2 coudé pour bougie sans olive  
(livré avec fil)



279369



longueur: 61mm Ø18mm  
adaptateur antiparasite



## FILTRE À AIR

|        |  |
|--------|--|
| 455407 | BOOSTER   BW'S 2004->   STUNT   SLIDER 2004-> type origine avec caoutchouc               |
| 375558 | BOOSTER   BW'S ->2003   STUNT   SLIDER ->2004   ROCKET   NG type origine avec caoutchouc |
| 372271 | NITRO   AEROX   OVETTO   NEOS NOIR type origine  |
| 462540 | LUDIX   JET FOCE C TECK type origine, démontable   |
| 480266 | TREKKER   VIVACITY   SPEEDFIGHT   TKR   BUXY type origine                                |
| 480267 | TYPHOON   RUNNER   NRG 1998->2004 2 temps type origine                                   |
| 487239 | PIAGGIO TYPHOON   ZIP 2 temps 2000->   STALKER   SR 2005->   NRG   DNA (B013227)         |
| 485934 | CPI   KEEWAY type origine  |
| 468832 | SCOOTER CHINOIS 50CC 10" 4 temps   |
| 468831 | SCOOTER CHINOIS 50CC 139QMB 12" 4 temps  |
| 468842 | SCOOTER CHINOIS 50CC   V CLIC   139QMB D732 grille 4 temps                               |



## FILTRE À AIR

|        |  |                                      |
|--------|--|--------------------------------------|
| 480263 | BOOSTER   BW'S 2004->   STUNT 2004-> type origine                | blanc                                |
| 473346 | BOOSTER   BW'S ->2003   STUNT   SLIDER BLANC ->2004 type origine | blanc                                |
| 458455 | BOOSTER   BW'S ->2003   STUNT   SLIDER ->2004   NG   ROCKET      | couverture transparent, mousse rouge |
| 480264 | NITRO   AEROX   OVETTO   NEOS type origine                       | blanc                                |
| 480265 | LUDIX   JET FORCE C TECK type origine                            | blanc                                |
| 480268 | TREKKER   VIVACITY   SPEEDFIGHT   BUXY   TKR type origine        | blanc                                |





**TEKNIX**  
Original Quality Controlled

### FILTRE À AIR CARTOUCHE

|        |  |
|--------|--|
| 484983 | OVETTO   NEOS   NITRO   AEROX 4 temps                        |
| 488150 | KISBEE 4 temps   |
| 482352 | AGILITY 10" KYMCO 4 temps                                    |
| 482351 | AGILITY 12"   VITALITY KYMCO 4 temps                         |
| 482353 | AGILITY 16"   DINK   PEOPLE   SUPER 8 KYMCO 4 temps          |
| 484207 | TWEET 50 et 125   SYM 125                                    |
| 493328 | SYM ORBIT 2   VIVACITY 3   SPEEDFIGHT 3 et 4   LUDIX 4 temps |



484983



488150



482352



482351



482353



484207

Sélection  
**CGN**

### MANCHON DE FILTRE À AIR

|        |  |
|--------|--|
| 372297 | BOOSTER   BW'S   STUNT   SLIDER   ROCKET |
|--------|--|



**DOPPLER**

### MOUSSE FILTRE À AIR DOUBLE DENSITÉ

|        |  |
|--------|--|
| 485242 | BOOSTER   BW'S   STUNT   SLIDER   ROCKET   NG  |
| 485243 | NITRO   AEROX   OVETTO   NEOS   JOG R   MACH G   |
| 485246 | SPEEDFIGHT 3   VIVACITY 3   KISBEE 2 temps   |
| 485245 | SPEEDFIGHT   VIVACITY   BUXY   TREKKER   TKR   |
| 485247 | TYPHOON   STALKER   ZIP   LX   FLY 2005-> 50CC   SR 2005->   NRG   SR motord   boulevard vespa |
| 485251 | TYPHOON ->1999   NRG MC1   STROM   NTT   |
| 485249 | CPI   POPCORN   HUSSARD   OLIVER   KEEWAY  |
| 485250 | SCOOTER CHINOIS 50CC 4 temps V CLIC 139QMB   |



485242



485243



485246



485245



485247



485251



485249



485250

FILTRE / FILTER

MOTEUR



**MOUSSE FILTRE À AIR**

|        |  |
|--------|--|
| 461227 | BOOSTER   BW'S   STUNT   SLIDER   NG   ROCKET  |
| 461228 | NITRO   AEROX   OVETTO   NEOS   MACH G   JOG R   ARK   |
| 461229 | SPEEDFIGHT   TREKKER   VIVACITY   BUXY   TKR   |
| 482634 | TYPHOON   STALKER   ZIP   LX   FLY 2005-> 50CC   SR 2005->   NRG   SR motord   boulevard vespa |
| 482635 | NRG MC1   TYPHOON ->1999   NTT   STROM 50CC ancien modèle                                      |
| 482636 | STALKER -> 2004   RUNNER 50CC ancien modèle  |



461227



461228



461229



482634



482635



482636



**MOUSSE FILTRE À AIR**

|        |  |
|--------|--|
| 492997 | BOOSTER   BW'S   STUNT   SLIDER   NG   ROCKET  |
| 492998 | NITRO   AEROX   OVETTO   NEOS   MACH G   JOG R   |
| 492999 | SPEEDFIGHT   TREKKER   VIVACITY   BUXY   TKR   |
| 493000 | TYPHOON   STALKER   ZIP   LX   FLY 2005-> 50CC   SR 2005->   NRG   SR motord   boulevard vespa |



492997



492998



492999



493000





## MOUSSE FILTRE À AIR

|        |   |
|--------|---|
| 247570 | BOOSTER   BWS   STUNT   SLIDER   NG   ROCKET  |
| 460458 | NITRO   AEROX   OVETTO   NEOS   FLIPPER   MACH G   F10                              |
| 466573 | LUDIX   JET FORCE C TECK  |
| 482666 | SPEEDFIGHT 3   VIVACITY 3   KISBEE 2 temps  |
| 287765 | TREKKER   BUXY   SPEEDFIGHT   VIVACITY   TKR  |
| 479805 | TYPHOON   STALKER   ZIP   LX   FLY 2005->   VESPA   NRG   SR 50 2005-> 50CC 2 temps |
| 251378 | TYPHOON ->1999   NRG MC1   NTT   STROM  |
| 478111 | PIAGGIO ZIP 4 temps 50 et 125   ZIP FAST RIDER 1993                                 |
| 482111 | VESPA LX   S   LIBERTY   FLY   125LX   LXV   X8                                     |
| 482109 | CPI   POPCORN   HUSSARD   OLIVER   KEEWAY   APRILIA                                 |
| 494791 | CPI   GENERIC   |
| 441467 | STALKER   RUNNER->2005   NRG MC2   non catalysé                                     |
| 468202 | SCOOTER CHINOIS 50CC 4 temps V CLIC 139QMB  |
| 485674 | SYM MIO 50/100  |
| 494790 | KYMCO SUPER 9   DINK   VITALITY   TOP BOY   |
| 494793 | PGO BIG MAX   |
| 494794 | KYMCO SNIPER   HEROISM   DJ   CX  |



247570



460458



466573



482666



287765



479805



251378



478111



482111



482109



494791



441467



468202



485674



494790



494793



494794



**DOPPLER**

## MOUSSE FILTRE À AIR DOUBLE DENSITÉ

|        |   |
|--------|---|
| 485253 | DERBI SENDA EURO 3 sauf DRD RACING 2009-> |
| 485244 | DERBI SENDA                               |
| 485254 | RIEJU RR   SPIKE                          |
| 485248 | TZR   X-POWER                             |



485253



485244



485254



485248



## MOUSSE FILTRE À AIR

|        |  |
|--------|--|
| 482110 | DERBI SENDA EURO 3 2006-> sauf DRD RACING 2009->   |
| 460457 | DERBI SENDA  |
| 482667 | RIEJU RR   SPIKE                                   |
| 482106 | X POWER   TZR                                      |
| 494792 | DERBI GPR ->2002   GP1                             |
| 497431 | PEUGEOT XP6   XPS   XP7                            |
| 497432 | DERBI GPR 2004 -> 2010   APRILIA   RS 2006 -> 2010 |



482110



460457



482667



482106



494792



## FILTRE À AIR

|        |                      |
|--------|----------------------|
| 626    | 103 SP   MVL complet |
| 480673 | 103 VOGUE complet    |
| 480672 | MBK 51 complet       |
| 3199   | CIAO PX complet      |
| Mousse |                      |
| 441466 | FOX   FXR            |



626



480673



480672



3199



441466



## FILTRE À AIR

|      |                                 |
|------|---------------------------------|
| 1379 | carburateur SHA 15   15 14   16 |
|------|---------------------------------|





**DOPPLER**

**MOUSSE FILTRE À AIR UNIVERSELLE DOUBLE DENSITÉ**

485252 200x300mm à découper



**MOUSSE FILTRE À AIR UNIVERSELLE DOUBLE DENSITÉ**

482645 21x29.7cm à découper



**MOUSSE FILTRE À AIR UNIVERSELLE DOUBLE DENSITÉ**

493001 42x29.7cm à découper



**MOUSSE FILTRE À AIR UNIVERSELLE**

484132 21x30cm à découper

490405 33x66x1 cm à découper

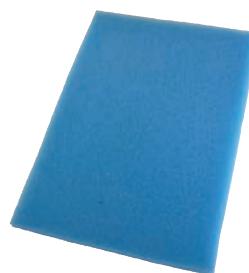

**FILTRE À AIR AIR BOX Ø28-35MM**

468867 moteur MINARELLI/PIAGGIO noir

468871 moteur MINARELLI/PIAGGIO gris

468864 moteur MINARELLI/PIAGGIO bleu



468867



468871



468864



**DOPPLER**

### FILTRE À AIR TUNING Ø28-35MM

|        |        |
|--------|--------|
| 458371 | noir   |
| 458370 | chrome |
| 473483 | blanc  |
| 458369 | bleu   |
| 458372 | rouge  |



458371



458370



473483



458369



458372

**DOPPLER**

### FILTRE À AIR AIR SYSTEM Ø28-35MM

|        |       |
|--------|-------|
| 324521 | noir  |
| 476297 | gris  |
| 473482 | blanc |
| 324517 | bleu  |
| 324547 | rouge |



324521



476297



473482



324517



324547

**DOPPLER**

### PIÈCES DÉTACHÉES

|        |   |
|--------|---|
| 376664 | mouss filtre à air pour filtre DOPPLER Tuning   |
| 368636 | mousse e filtre à air rouge avec grille chromée |
| 368674 | collier filtre à air (x1)                       |
| 461830 | épingle de support                              |
| 368660 | manchon Ø28-35mm avec collier de fixation       |



376664



368636



368674



461830



368660



**PIÈCES DÉTACHÉES**

|        |   |
|--------|---|
| 290707 | E5 PHBG Ø28mm couvercle noir                          |
| 290715 | E5 PHBG Ø28mm noir mousse rouge                       |
| 290677 | E5 PHBN/PHVA (sauf PEUGEOT) Ø35mm noir mousse rouge   |
| 290681 | E5 PHBN/PHVA (sauf PEUGEOT) Ø35mm chrome mousse rouge |
| 290696 | E5 PHBN/PHVA (sauf PEUGEOT) Ø35mm couvercle chrome    |
| 1394   | E5 PHBN/PHVA (sauf PEUGEOT) Ø35mm couvercle noir      |
| 461226 | E5 SPEEDFIGHT   TREKKER noir mousse rouge             |
| 475421 | E14 Ø28-35mm  |



290707



290715



290677



290681



290696



1394



461226



475421



**FILTRE À AIR TYPE KN**

|        |       |
|--------|-------|
| 486400 | Ø39mm |
| 485340 | Ø42mm |



486400



485340



**FILTRE À AIR COOL Ø28-35MM**

|        |                 |
|--------|-----------------|
| 480883 | noir coudé 90°  |
| 480884 | rouge coudé 90° |
| 480879 | noir droit      |
| 480880 | rouge droit     |
| 480881 | bleu droit      |
| 480882 | jaune droit     |



480883



480884



480879



480880



480881



480882



**FILTRE À AIR ÉVOLUTION 2 FIXATION COUDÉE 30°  
Ø28-35MM**

- 467765 corps noir mousse rouge
- 467766 corps blanc mousse noire
- 467767 corps bleu mousse noire



467765



467766



467767



**FILTRE À AIR HÉXAGONAL FIXATION COUDÉE 30°  
Ø28-35MM**

- 467760 corps blanc mousse noire
- 467759 corps blanc mousse bleue
- 467761 corps blanc mousse rouge



467760



467759



467761



**FILTRE À AIR E5 FIXATION COUDÉE 45°  
Ø28-35MM**

- 462154 carbone brillant mousse rouge
- 462155 carbone mat mousse rouge
- 466743 chrome
- 440956 noir



462154



462155



466743



440956



**FILTRE À AIR MUFFLER FIXATION COUDÉE 45°  
Ø28-35MM**

- 475816 bleu
- 475817 rouge



475816



475817



**FILTRE À AIR GPI FIXATION COUDÉE 45°  
Ø28-35MM**

- 475825 bleu





**FILTRE À AIR RÉACTEUR FIXATION COUDÉE 45°  
Ø28-35MM**

- 477408 blanc
- 477409 rouge



**FILTRE À AIR CONIQUE KN GM FIXATION COUDÉE  
90° Ø28-35MM**

- 482502 carbone
- 482503 chrome
- 482501 rouge
- 482499 bleu
- 482500 blanc



**FILTRE À AIR CONIQUE KN PM FIXATION COUDÉE  
90° Ø28-35MM**

- 482337 carbone
- 482336 chrome
- 328091 rouge
- 328087 bleu
- 482338 blanc



**FILTRE À AIR PERFO FIXATION COUDÉE 90°  
Ø28-35MM**

- 333613 carbone



**FILTRE À AIR CONIQUE FIXATION DROITE  
Ø28-35MM**

- 291802 chrome
- 268619 noir/chrome
- 327975 rouge/chrome
- 327967 bleu/chrome





**FILTRE À AIR CONIQUE KN GM FIXATION DROITE  
Ø28-35MM**

- 322108 carbone
- 482333 chrome
- 322093 rouge
- 480761 rouge brillant
- 322112 bleu
- 480760 blanc
- 480762 jaune brillant



322108

482333

322093

480761

322112

480760

480762



**FILTRE À AIR CONIQUE KN PM FIXATION DROITE  
Ø28-35MM**

- 482335 carbone
- 451734 chrome
- 480759 rouge brillant
- 482334 bleu
- 480758 blanc

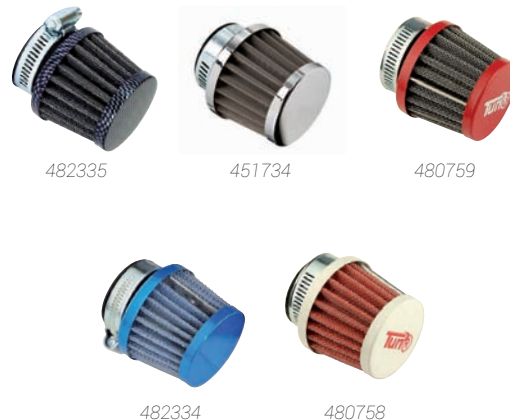

482335

451734

480759

482334

480758



**FILTRE À AIR CYLINDRIQUE FIXATION DROITE  
Ø28-35MM**

- 282801 extra plat chrome
- 328053 grille bleue
- 328068 grille rouge
- 328072 grille violette



282801

328053

328068

328072



**FILTRE À AIR DÉBIT VARIABLE PM FIXATION  
DROITE Ø28-35MM**

- 292450 carbone
- 291817 bleu



292450

291817





**FILTRE À AIR HÉLICE FIXATION DROITE Ø28-35MM**

334309 chrome



**FILTRE À AIR ES FIXATION DROITE Ø28-35MM**

440805 noir



**FILTRE À AIR CONIQUE KN GM ORIENTABLE 0° À 90° Ø28-35MM**

480756 noir filtre vert



**FILTRE À AIR CONIQUE KN PM ORIENTABLE 0° À 90° Ø28-35MM**

480757 noir filtre vert



**FILTRE À AIR ES FIXATION COUDÉE ANGLE VARIABLE Ø28-35MM**

466741 noir

466742 chrome



466741



466742



**FILTRE À AIR HÉXAGONAL FIXATION COUDÉE ANGLE VARIABLE Ø28-35MM**

466739 chrome mousse rouge



**FILTRE À AIR CYLINDRIQUE KN ANGLE VARIABLE 0° À 90° Ø28-35MM**

497407 noir/noir

497408 noir/violet



497407



497408



## FILTRE À AIR DIVERS Ø28-35MM

- 268623** KN soucoupe droit chrome
- 467902** obus fixation coudée 30° corps blanc mousse rouge
- 467817** double mousse fixation coudée 30° double mousse rouge/noir
- 460013** phonique fixation droite mousse rouge
- 477406** big filter fixation coudée 45° vert



268623



467902



467817



460013



477406



## FILTRE À AIR CHROME

- 1382** carburateur PHBG conique kn fixation coudée 90°
- 1381** carburateur SHA cornet chrome
- 260269** carburateur SHA cornet chrome + élément filtrant
- 478327** carburateur SHA racing
- 1387** E8 PHBG coudé Ø28mm
- 3198** E12 PHBG Ø28mm



1382



1381



260269



478327



1387



3198



## ADAPTATEUR FILTRE À AIR Ø28-35MM

- 440073** coudé
- 292437** droit



440073



292437



### FILTRE À AIR AIR BOX ÉTANCHE

- 461842** 50 coudé 30° PHBH 203.0092 Ø42mm
- 462347** 50 DROIT PHVA 203.0081 Ø37mm
- 461841** BT fixation coudée 30° D37 PHVA 203.0091 Ø37mm
- 461849** BX/TY fixation coudée 30° PHBG 203.0090 Ø32mm
- 468396** fixation coudée 90° PHBG 203.0093 Ø32mm
- 468397** fixation coudée 90° PHVA 203.0094 Ø37mm
- 468398** fixation coudée 90° PHBG 203.0095 Ø32mm
- 468399** PM fixation coudée 90° PHVA 203.0096 Ø37mm
- 483208** 50 droit PHVA 203.0082 Ø46mm
- 495864** 50 coudé 90° PHVA 203.0098 Ø46mm

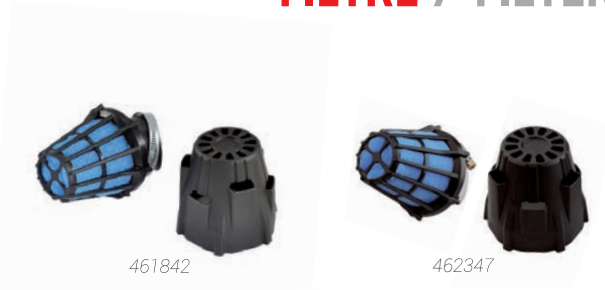

461842

462347



461841

461849



468396



468397



468398



468399



483208



495864



### FILTRE À AIR MOUSSE

- 1393** PHVA/PHBN court droit Ø36mm 203.0032



### FILTRE À AIR RAPTOR

- 481247** corps chromé et cache vis noir



### POUMON ALU A.S.C AVEC FIXATION

- 292775** poli



### POUMON

- 472428** rouge
- 472427** bleu



472428

472427

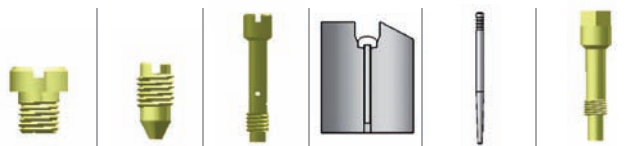

**CARBURATEUR PHBN**

|        |   | Principale | Ralenti | Starter | Boisseau | Aiguille | Diffuseur |
|--------|---|------------|---------|---------|----------|----------|-----------|
| 450442 | 12 BT   AM 5 dépression, graissage, starter câble         | 93         | 36      | 40      | 40       | A21      | 211GA     |
| 1230   | 16 BT dépression, graissage, starter câble                | 72         | 34      | 50      | 40       | A21      | 210FA     |
| 461503 | 16 BT avec réchauffeur                                    | 76         | 34      | 45      | 40       | A39      | 210HA     |
| 1231   | 17.5 BT dépression, graissage, réchauffeur, starter câble | 90         | 34      | 50      | 40       | A12      | 214GA     |



**A: GICLEUR**

| N°     |     |
|--------|-----|
| 480444 | 54  |
| 480443 | 58  |
| 208510 | 60  |
| 208524 | 62  |
| 208539 | 64  |
| 437977 | 65  |
| 208543 | 66  |
| 208558 | 68  |
| 208562 | 70  |
| 1256   | 72  |
| 174794 | 75  |
| 174809 | 78  |
| 174813 | 80  |
| 174828 | 82  |
| 174832 | 83  |
| 174847 | 84  |
| 174851 | 85  |
| 174866 | 88  |
| 174877 | 90  |
| 174885 | 91  |
| 174890 | 92  |
| 174904 | 93  |
| 174919 | 94  |
| 174923 | 95  |
| 174938 | 96  |
| 174942 | 98  |
| 174957 | 100 |
| 174976 | 102 |
| 174987 | 103 |
| 174995 | 104 |
| 175001 | 105 |
| 175016 | 106 |
| 175027 | 107 |

**A: GICLEUR**

| N°     |     |
|--------|-----|
| 175035 | 108 |
| 175040 | 109 |
| 175054 | 110 |
| 175069 | 112 |
| 175073 | 114 |
| 297485 | 115 |
| 175088 | 118 |
| 175092 | 120 |
| 175107 | 122 |
| 175111 | 125 |
| 175126 | 128 |
| 175137 | 130 |
| 451817 | 132 |
| 451818 | 134 |
| 451819 | 135 |
| 472421 | 136 |
| 451820 | 138 |
| 451821 | 140 |
| 451822 | 142 |
| 197305 | 145 |
| 197310 | 148 |
| 197324 | 150 |
| 197339 | 152 |
| 451824 | 160 |
| 451825 | 166 |

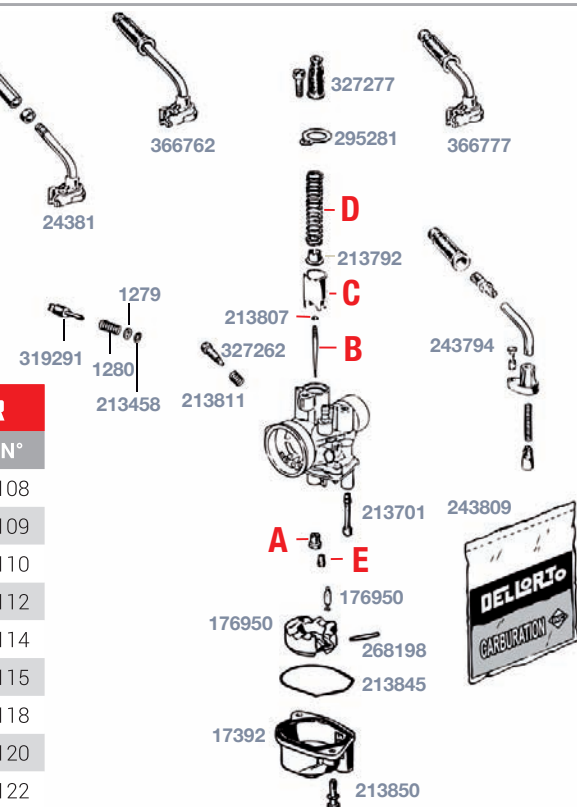

**E: GICLEUR RALENTI PHBN/PHVA**

|        |    |
|--------|----|
| 450504 | 32 |
| 176277 | 34 |
| 450503 | 40 |
| 451815 | 42 |

**PIÈCES CARBURATEUR**

|        |   |
|--------|---|
| 327277 | vis de couvercle boisseau PHBN/PHVA                                 |
| 295281 | joint de couvercle boisseau PHBN                                    |
| 243813 | couvercle de boisseau PHBN avec raccord complet, sans joint ni vis  |
| 366762 | couvercle de boisseau PHBN 17.5 complet, sans joint ni vis          |
| 366777 | couvercle de boisseau PHBN 16 complet, sans joint ni vis            |
| 213792 | rondelle fond boisseau PHBN/PHVA                                    |
| 213807 | clips aiguille PHBN/PHVA  |
| 327262 | vis d'air PHBN/PHVA   |
| 213811 | ressort vis air PHBN/PHVA   |
| 319291 | vis de ralenti PHBN/PHVA BX   |
| 1280   | ressort de vis richesse PHBG, vis ralenti PHBN, vis ralenti PHVA BX |
| 1279   | rondelle vis richesse PHBG, vis ralenti PHBN, vis ralenti PHVA BX   |
| 213458 | joint vis richesse PHBG, vis ralenti PHBN, vis ralenti PHVA BX      |
| 243794 | starter PHBN complet manuel à câble                                 |
| 243809 | joint PHBN pochette   |
| 213701 | gicleur starter PHBN/PHVA   |
| 176950 | flotteur PHBN/PHVA 3.5G, kit réparation axe et pointeau             |
| 268198 | axe flotteur PHBN/PHVA  |
| 213845 | joint cuve PHBN/PHVA  |
| 173927 | cuve PHBN/PHVA noir   |
| 213850 | vis de cuve PHBN/PHVA avec rondelle                                 |
| 491157 | pointeau PHVA   |

**B: AIGUILLE PHBN/PHVA**

|        |     |
|--------|-----|
| 295167 | A2  |
| 295186 | A7  |
| 366724 | A12 |
| 295171 | A13 |
| 213410 | A20 |

**C: BOISSEAU PHBN**

|        |  |
|--------|--|
| 295133 | 16 (Ø15   H29   C30)                       |
| 175729 | 17.5   PHVA adaptable BX (Ø16   H31   C40) |

**D: RESSORT BOISSEAU PHBN**

|        |                                      |
|--------|--------------------------------------|
| 295152 | 16 (Ø12   L50)                       |
| 295148 | 17.5   PHVA adaptable BX (Ø12   L57) |

# CARBURATION / CARBURATION

## PHVA

### DELEORTO

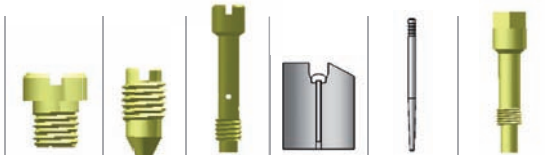

### TUN'R

#### CARBURATEUR PHVA

|        |   | Principale | Ralenti | Starter | Boisseau | Aiguille | Diffuseur |
|--------|---|------------|---------|---------|----------|----------|-----------|
| 479671 | 12 BOOSTER   BW'S 2004 (starter électrique)             | 78         | 38      | 48      | 40       | A12      | 211GA     |
| 191288 | 17.5 BX/BT 2004 dépression, graissage, réchauffeur      | 80         | 38      | 45      | 40       | A20      | 211GA     |
| 252192 | 17.5 SD dépression, graissage, réchauffeur              | 83         | 34      | 50      | 40       | A07      | 212FA     |
| 3194   | 17.5 TY   | 65         | 34      | 50      | 40       | A07      | 211FA     |
| 495281 | 17.5 TS LUDIX   TKR   VIVACITY   TREKKER montage souple | 95         | 38      | 45      | 40       | A2       | 209EGA    |

#### CARBURATEUR PHVA

492301 17.5 dépression, graissage, starter tirette, avec 6 gicleurs



### DELEORTO

#### A: GICLEUR PHVA/PHBN

| N°     | N°  |
|--------|-----|
| 480444 | 54  |
| 480443 | 58  |
| 208510 | 60  |
| 208524 | 62  |
| 208539 | 64  |
| 437977 | 65  |
| 208543 | 66  |
| 208558 | 68  |
| 208562 | 70  |
| 1256   | 72  |
| 174794 | 75  |
| 174809 | 78  |
| 174813 | 80  |
| 174828 | 82  |
| 174832 | 83  |
| 174847 | 84  |
| 174851 | 85  |
| 174866 | 88  |
| 174877 | 90  |
| 174885 | 91  |
| 174890 | 92  |
| 174904 | 93  |
| 174919 | 94  |
| 174923 | 95  |
| 174938 | 96  |
| 174942 | 98  |
| 174957 | 100 |
| 174976 | 102 |
| 174987 | 103 |
| 174995 | 104 |
| 175001 | 105 |
| 175016 | 106 |
| 175027 | 107 |

#### A: GICLEUR PHVA/PHBN

| N°     | N°  |
|--------|-----|
| 175035 | 108 |
| 175040 | 109 |
| 175054 | 110 |
| 175069 | 112 |
| 175073 | 114 |
| 297485 | 115 |
| 175088 | 118 |
| 175092 | 120 |
| 175107 | 122 |
| 175111 | 125 |
| 175126 | 128 |
| 175137 | 130 |
| 451817 | 132 |
| 451818 | 134 |
| 451819 | 135 |
| 472421 | 136 |
| 451820 | 138 |
| 451821 | 140 |
| 451822 | 142 |
| 197305 | 145 |
| 197310 | 148 |
| 197324 | 150 |
| 197339 | 152 |
| 451824 | 160 |
| 451825 | 166 |
| 295167 | A2  |
| 295186 | A7  |
| 366724 | A12 |
| 295171 | A13 |
| 213410 | A20 |

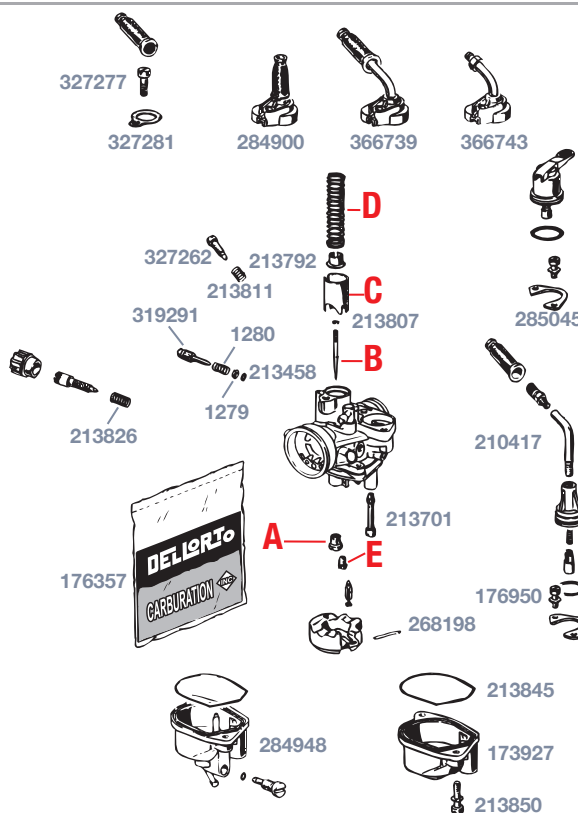

#### PIÈCES CARBURATEUR

|        |   |
|--------|---|
| 327277 | vis de couvercle boisseau PHBN/PHVA                               |
| 327281 | joint couvercle boisseau PHVA                                     |
| 366739 | couvercle boisseau PHVA TY  |
| 366743 | couvercle boisseau PHVA BX  |
| 284900 | couvercle boisseau PHVA SD  |
| 213792 | rondelle fond boisseau PHBN/PHVA                                  |
| 213807 | clips aiguille PHBN / PHVA  |
| 327262 | vis d'air PHBN/PHVA   |
| 213811 | ressort vis air PHBN/PHVA   |
| 319291 | vis de ralenti PHBN/PHVA BX                                       |
| 1280   | ressort vis richesse PHBG, vis ralenti PHBN, vis ralenti PHVA BX  |
| 1279   | rondelle vis richesse PHBG, vis ralenti PHBN, vis ralenti PHVA BX |
| 213458 | joint vis richesse PHBG, vis ralenti PHBN, vis ralenti PHVA BX    |
| 285045 | starter PHVA BX/TY/SD à gachette                                  |
| 210417 | starter PHVA manuel à câble complet                               |
| 176357 | joint PHVA (pochette)   |
| 213701 | gicleur starter PHBN/PHVA 50                                      |
| 176950 | flotteur PHBN/PHVA 3.5G, kit réparation axe et pointeau           |
| 268198 | axe flotteur PHBN/PHVA  |
| 213845 | joint cuve PHBN/PHVA  |
| 173927 | cuve PHBN/PHVA noir   |
| 284948 | cuve PHVA BX noir avec joint                                      |
| 213850 | vis de cuve PHBN/PHVA avec rondelle                               |

#### C: BOISSEAU PHVA

|        |                                       |
|--------|---------------------------------------|
| 175729 | PHBN 17.5   PHVA BX (Ø16   H31   C40) |
| 284790 | PHVA TY   SD (Ø16   H25   C40)        |

#### D: RESSORT BOISSEAU PHVA

|        |                                 |
|--------|---------------------------------|
| 284933 | PHVA TY   SD (Ø12   L53)        |
| 295148 | PHBN 17.5   PHVA BX (Ø12   L57) |

#### E: GICLEUR RALENTI PHBN/PHVA

|        |    |
|--------|----|
| 450504 | 32 |
| 176277 | 34 |
| 450503 | 40 |
| 451815 | 42 |

#### DIFFUSEUR PHVA

|        |                                    |
|--------|------------------------------------|
| 485306 | HA208 DERBI EURO 3 montage origine |
| 485498 | HM208 DERBI EURO 3                 |



CARBURATEUR SHA

|        |            | Principale |
|--------|------------|------------|
| 3191   | 12/12 CIAO | 48         |
| 3193   | 13/13 CIAO | 66         |
| 1222   | 15/15      | 68         |
| 477487 | 16/16      | 70         |

A: GICLEUR  
SHA/PHBG

| N°     | N°  |
|--------|-----|
| 1255   | 50  |
| 174043 | 52  |
| 174058 | 55  |
| 174062 | 56  |
| 174077 | 57  |
| 174081 | 58  |
| 174107 | 60  |
| 174115 | 61  |
| 174120 | 62  |
| 174134 | 63  |
| 174149 | 64  |
| 497107 | 65  |
| 174153 | 66  |
| 174168 | 68  |
| 174172 | 69  |
| 174187 | 70  |
| 174206 | 72  |
| 174217 | 73  |
| 174225 | 74  |
| 174230 | 75  |
| 174244 | 76  |
| 174259 | 78  |
| 174263 | 79  |
| 174278 | 80  |
| 174282 | 81  |
| 174297 | 82  |
| 174301 | 83  |
| 174316 | 84  |
| 174327 | 85  |
| 174335 | 86  |
| 174340 | 87  |
| 174354 | 88  |
| 174369 | 89  |
| 174373 | 90  |
| 174388 | 91  |
| 174392 | 92  |
| 174407 | 94  |
| 174411 | 95  |
| 174426 | 96  |
| 174437 | 97  |
| 174445 | 98  |
| 174450 | 100 |
| 174464 | 101 |
| 174479 | 102 |
| 174483 | 103 |
| 174498 | 104 |
| 174502 | 105 |
| 174517 | 106 |
| 174521 | 107 |
| 174536 | 108 |
| 174547 | 109 |
| 174555 | 110 |
| 174560 | 112 |
| 174574 | 115 |
| 174589 | 118 |
| 174593 | 120 |
| 174608 | 122 |
| 174612 | 124 |
| 174627 | 128 |
| 174631 | 130 |
| 174646 | 132 |
| 174657 | 135 |
| 174665 | 138 |
| 174670 | 140 |
| 174684 | 142 |
| 174699 | 145 |
| 174703 | 150 |

B: BOISSEAU

1311 SHA

PIÈCES CARBURATEUR

- 1341 coude guide câble SHA (jeu)
- 1262 caoutchouc étanchéité gaine, câble PHBG/SHA/PHBN/PHVA
- 1263 vis tendeur câble boisseau PHBG/SHA

- 1315 couvercle boisseau SHA complet, ressort et joint
- 1317 joint couvercle boisseau SHA
- 1318 ressort boisseau SHA
- 213496 écrou collier serrage SHA
- 1320 vis de pipette essence SHA
- 1321 pipette essence SHA
- 1322 filtre essence, crepine pipette carbu SHA
- 1330 ressort vis ralenti SHA
- 1326 bague d'étanchéité SHA 15
- 1329 vis de ralenti SHA
- 1328 vis de collier serrage SHA
- 1286 pointeau PHBG/SHA
- 1332 axe flotteur SHA
- 1312 flotteur SHA
- 1333 joint cuve SHA
- 1334 cuve SHA noir avec joint
- 1337 vis de cuve SHA avec rondelle
- 1338 filtre à air SHA élément filtrant
- 1379 filtre à air SHA 15/15

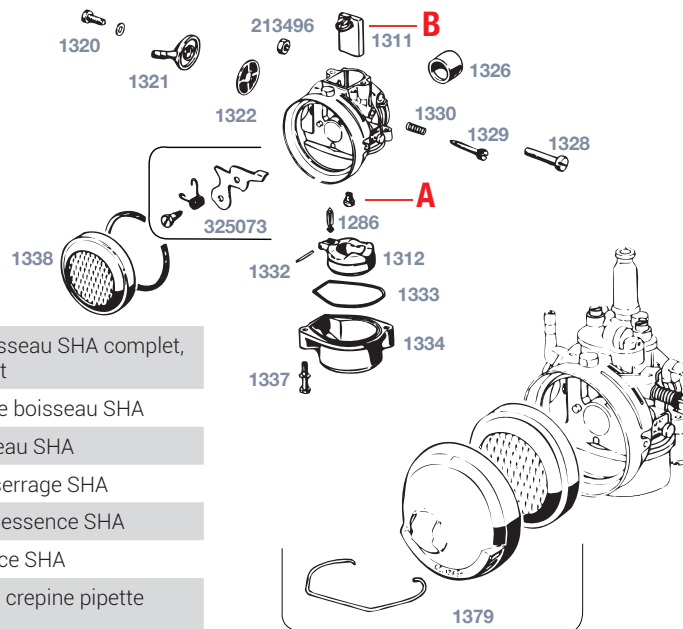
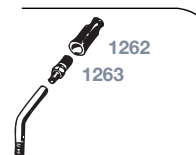

KIT DE TRANSFORMATION

- 482548 montage souple venturisé SHA
- 491146 bague montage souple venturisé SHA 14/15/16



# CARBURATION / CARBURATION

**DELEORTO**

## CARBURATEUR PHBL

|               |  | Principale | Ralenti | Starter | Boisseau | Aiguille | Diffuseur |
|---------------|--|------------|---------|---------|----------|----------|-----------|
| <b>450121</b> | 25 AM/SD montage souple, starter tirette                   | 108        | 52      | 70      | 40       | D37      | 264K      |
| <b>441293</b> | 25 BT montage souple, starter tirette                      | 102        | 70      | 60      | 40       | D22      | AQ266     |
| <b>Pièces</b> |  |            |         |         |          |          |           |
| <b>175695</b> | commande starter PHBG manuel avec collier RS50   GPR   RS1 |            |         |         |          |          |           |
| <b>325862</b> | prise dépression Ø5mm                                      |            |         |         |          |          |           |
| <b>491088</b> | starter PHBL manuel à câble, complet                       |            |         |         |          |          |           |



450121



441293

**DELEORTO**

## CARBURATEUR PHBL

|               |       | Principale | Ralenti | Starter | Boisseau | Aiguille | Diffuseur |
|---------------|-------|------------|---------|---------|----------|----------|-----------|
| <b>477591</b> | 28 BS | 105        | 55      | 70      | 40       | X2       | AV264     |



**DELEORTO**

## CARBURATEUR PHVB

|               |  | Principale | Ralenti | Boisseau |
|---------------|--|------------|---------|----------|
| <b>491087</b> | 19 DD montage souple avec graissage starter auto | 85         | 45      | 40       |
| <b>491085</b> | 22 CD montage souple avec dépression graissage   | 95         | 45      | 40       |
| <b>491086</b> | 22 CD montage souple avec dépression graissage   | 45         | 45      | 40       |



491087



491085



491086

**DELEORTO**

## CUVE PHVB

**496446** Cuve PHVB noir



**CARBURATION / CARBURATION**

**DELEORTO**

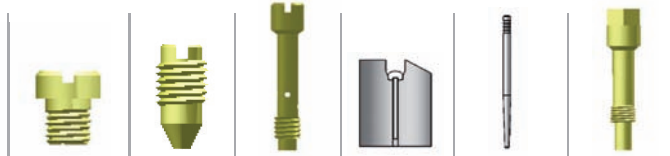

**CARBURATEUR VHST**

|               |   | Principale | Ralenti | Starter | Boisseau | Aiguille | Diffuseur |
|---------------|---|------------|---------|---------|----------|----------|-----------|
| <b>491083</b> | 26 BS montage souple sans graissage et boisseau | 182        | 436     | 80      | 45       | D563     | AQ269     |
| <b>491084</b> | 28 BS montage souple sans graissage et boisseau | 184        | 436     | 80      | 45       | D563     | AQ269     |



**PHBG**

**DELEORTO**

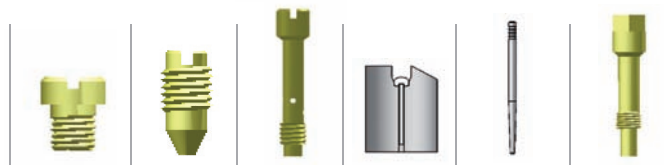

**CARBURATEUR PHBG**

|               |  | Principale | Ralenti | Starter | Boisseau | Aiguille | Diffuseur |
|---------------|--|------------|---------|---------|----------|----------|-----------|
| <b>1228</b>   | 15 montage souple starter câble                        | 72         | 50      | 60      | 40       | W7       | 262AU     |
| <b>477491</b> | 17 montage souple graissage                            | 70         | 45      | 65      | 50       | W16      | 258AN     |
| <b>1225</b>   | 17 montage rigide starter par tirette                  | 78         | 50      | 60      | 40       | W7       | 262AU     |
| <b>1226</b>   | 19 montage rigide starter tirette                      | 85         | 50      | 60      | 40       | W7       | 262AU     |
| <b>297686</b> | 19 montage souple                                      | 95         | 50      | 60      | 40       | W6       | 262AU     |
| <b>460858</b> | 19 AM montage souple avec graissage et dépression      | 75         | 45      | 60      | 30       | W9       | 262AN     |
| <b>252207</b> | 19 AM montage rigide avec graissage starter tirette    | 75         | 45      | 60      | 30       | W9       | 262AN     |
| <b>450116</b> | 19 BT montage souple graissage, dépression             | 75         | 45      | 60      | 30       | W9       | 262AN     |
| <b>477489</b> | 21 montage rigide avec graissage starter tirette       | 92         | 50      | 60      | 40       | W7       | 262AU     |
| <b>1227</b>   | 21 AS montage rigide                                   | 100        | 50      | 60      | 40       | W3       | 262AU     |
| <b>1233</b>   | 21 BT montage souple dépression graissage              | 92         | 50      | 60      | 40       | W7       | 262AU     |
| <b>491082</b> | 21 DS RACING montage souple, graissage et dépression   | 92         | 50      | 60      | 40       | W7/2A    | 262AU     |
| <b>495299</b> | 15 AS, montage rigide, starter par tirette             |            |         |         |          |          |           |
| <b>121177</b> | 19.5 AD, montage rigide, starter à câble               |            |         |         |          |          |           |
| <b>494788</b> | 21 AD, montage rigide, sans graissage, starter à câble |            |         |         |          |          |           |





## PHBG

### DELLORTO

#### A: GICLEUR PHBG/SHA

| N°     | N° |
|--------|----|
| 1255   | 50 |
| 174043 | 52 |
| 174058 | 55 |
| 174062 | 56 |
| 174077 | 57 |
| 174081 | 58 |
| 174107 | 60 |
| 174115 | 61 |
| 174120 | 62 |
| 174134 | 63 |
| 174149 | 64 |
| 497107 | 65 |
| 174153 | 66 |
| 174168 | 68 |
| 174172 | 69 |
| 174187 | 70 |
| 174206 | 72 |
| 174217 | 73 |
| 174225 | 74 |
| 174230 | 75 |
| 174244 | 76 |
| 174259 | 78 |
| 174263 | 79 |
| 174278 | 80 |
| 174282 | 81 |
| 174297 | 82 |
| 174301 | 83 |
| 174316 | 84 |
| 174327 | 85 |
| 174335 | 86 |
| 174340 | 87 |
| 174354 | 88 |
| 174369 | 89 |
| 174373 | 90 |
| 174388 | 91 |
| 174392 | 92 |
| 174407 | 94 |
| 174411 | 95 |
| 174426 | 96 |
| 174437 | 97 |
| 174445 | 98 |

#### A: GICLEUR PHBG/SHA

| N°     | N°  |
|--------|-----|
| 174450 | 100 |
| 174464 | 101 |
| 174479 | 102 |
| 174483 | 103 |
| 174498 | 104 |
| 174502 | 105 |
| 174517 | 106 |
| 174521 | 107 |
| 174536 | 108 |
| 174547 | 109 |
| 174555 | 110 |
| 174560 | 112 |
| 174574 | 115 |
| 174589 | 118 |
| 174593 | 120 |
| 174608 | 122 |
| 174612 | 124 |
| 174627 | 128 |
| 174631 | 130 |
| 174646 | 132 |
| 174657 | 135 |
| 174665 | 138 |
| 174670 | 140 |
| 174684 | 142 |
| 174699 | 145 |
| 174703 | 150 |

#### B: AIGUILLE PHBG

|        |     |
|--------|-----|
| 472558 | W1  |
| 1245   | W2  |
| 1246   | W4  |
| 1247   | W5  |
| 1248   | W6  |
| 1249   | W7  |
| 1250   | W8  |
| 1251   | W9  |
| 451826 | W11 |
| 451827 | W12 |
| 451828 | W13 |
| 280043 | W16 |

#### C: BOISSEAU PHBG

|      |    |
|------|----|
| 1244 | 30 |
| 1243 | 40 |

#### D: GICLEU RALENTI PHBG

|        |    |
|--------|----|
| 477189 | 35 |
| 1259   | 40 |
| 213549 | 45 |
| 213553 | 50 |
| 213568 | 55 |
| 213572 | 60 |

#### PIÈCES CARBURATEUR PHBG

|        |   |
|--------|---|
| 1267   | joint couvercle boisseau PHBG                               |
| 1266   | couvercle boisseau PHBG avec vis                            |
| 1269   | rondelle fond boisseau PHBG                                 |
| 1268   | ressort boisseau PHBG                                       |
| 1270   | clips aiguille PHBG   |
| 1284   | vis de ralenti PHBG avec ressort                            |
| 1282   | ressort vis ralenti PHBG                                    |
| 265677 | vis de richesse PHBG complet                                |
| 1279   | rondelle vis richesse PHBG, vis ralenti PHBN et PHVA BX     |
| 1280   | ressort vis richesse PHBG, vis ralenti PHBN et PHVA BX      |
| 213458 | joint vis richesse PHBG, vis ralenti PHBN et PHVA BX        |
| 1271   | starter PHBG manuel à tirette                               |
| 1272   | joint starter PHBG à tirette                                |
| 1295   | starter PHBG manuel à câble (complet)                       |
| 1262   | caoutchouc étanchéité gaine, câble PHBG   SHA   PHBN   PHVA |
| 1263   | vis tendeur de câble boisseau PHBG/SHA                      |
| 1305   | coude PHBG 90°  |

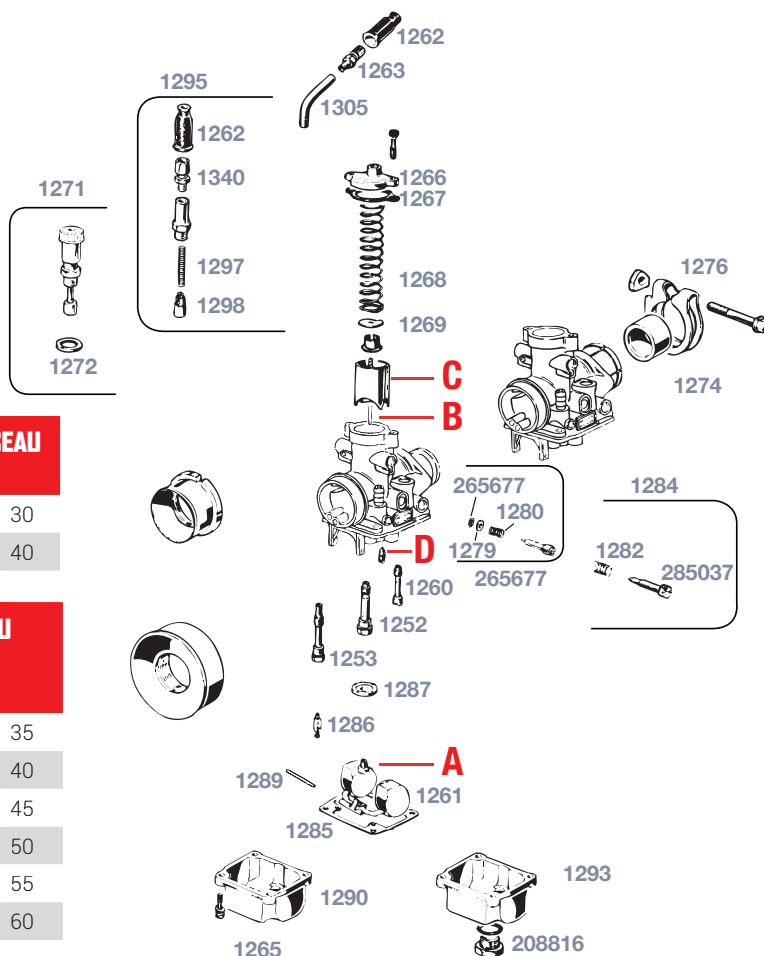

|        |  |
|--------|--|
| 1340   | vis tendeur câble starter, boisseau PHBG 6 pans        |
| 1297   | ressort starter PHBG                                   |
| 1298   | valve starter PHBG                                     |
| 1260   | gicleur starter PHBG 55                                |
| 1252   | diffuseur PHBG AN262                                   |
| 1253   | diffuseur PHBG AU264                                   |
| 1287   | rondelle diffuseur PHBG anti-émulsion                  |
| 1286   | pointeau PHBG/SHA                                      |
| 1261   | flotteur PHBG 4G                                       |
| 1289   | axe flotteur PHBG                                      |
| 1285   | joint cuve PHBG  |
| 1265   | vis de cuve, couvercle boisseau PHBG/SHA avec rondelle |
| 1290   | cuve PHBG noir plastique                               |
| 1293   | cuve PHBG alu nue                                      |
| 208816 | bouchon cuve PHBG alu                                  |
| 1274   | bague d'étanchéité Ø24 pour PHBG 19                    |
| 1276   | collier serrage PHBG                                   |
| 1300   | cornet VENTURI PHBG Ø40                                |
| 1301   | cornet VENTURI PHBG Ø60                                |
| 494878 | couvercle de boisseau PHBG à visser                    |

PHBG



PIÈCES CARBURATEUR

495197 couvercle de boisseau PHBG extra palt spécial 103 | MBR KOMOS



**INFO + :**  
Retrouvez les câbles de gaz **page 527.**



CARBURATEUR CP

- 483794 15 dépression, graissage, starter à câble
- 483202 15 dépression, graissage, starter à câble
- 483201 17.5 dépression, graissage, starter à câble
- 483795 17.5 dépression, graissage, starter à câble
- 483796 17.5 dépression, graissage, starter à tirette
- 483203 19 dépression, graissage, starter à câble
- 485918 19 103 complet, avec pipe, filtre et mousse double densité
- 483204 21 dépression, graissage, starter à câble
- 483205 23 dépression, graissage, starter à câble



483795



485918

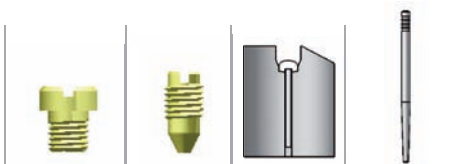

CARBURATEUR PWK

479495 24mm, dépression, starter tirette

Principale Ralenti Boisseau Aiguille

120 38 N68E



CARBURATEUR PWK AVEC POWER JET

- 496088 Ø21mm
- 496089 Ø24mm
- 496090 Ø26mm
- 496091 Ø28mm

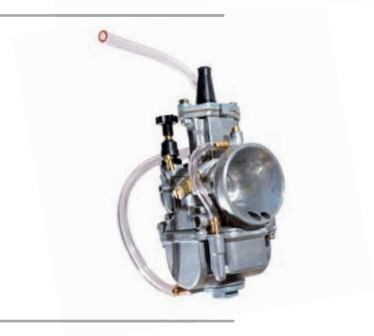

PIÈCES CARBURATEUR

- 483206 starter CP/PWK manuel à tirette
- 483850 coude CP 45°
- 483851 coude CP 90°



483206



483850

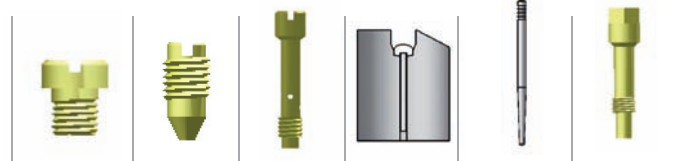

## CARBURATEUR 1/1

|               | Principale   | Ralenti | Starter | Boisseau | Aiguille | Diffuseur |
|---------------|--|---------|---------|----------|----------|-----------|
| <b>481467</b> | PHBN 12 BT avec dépression, graissage, starter à câble |         |         |          |          |           |
| <b>468460</b> | 82   |         |         |          |          |           |
| <b>478708</b> | 82   | 55      | 55      | 30       | W6       | 262AU     |
| <b>467793</b> | 72   | 48      | 60      | 40       | W16      | 262AU     |
| <b>467791</b> | 72   | 48      | 60      | 40       | W16      | 262AU     |
| <b>473460</b> | 72   | 48      | 60      | 50       | W16      | 262AU     |
| <b>466778</b> | 88   | 38      | 50      |          | A12      | 209       |
| <b>467792</b> | 92   | 50      | 60      | 40       | W7       |           |
| <b>478740</b> | PHBL 25  |         |         |          |          |           |
| <b>475871</b> | 102  | 70      | 60      | 40       | D22      |           |
| <b>472645</b> | 180  | 48      |         |          | JJH      |           |
| <b>478722</b> | 105  | 55      | 70      | 40       | X2       | AV264     |



481467



468460



478708



467793



467791



473460



466778



467792



478740



475871



472645



478722

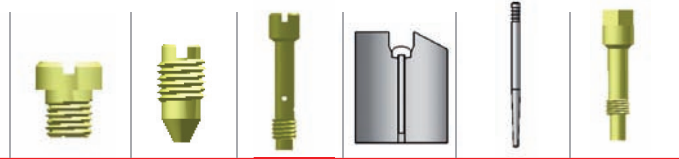

CARBURATEUR 2/2

|  | Principale | Ralenti | Starter | Boisseau | Aiguille | Diffuseur |
|--|------------|---------|---------|----------|----------|-----------|
| <b>481466</b> PHVA 12 BOOSTER   NITRO 2004->   SPEEDFIGHT<br>dépression, graissage |            |         |         |          |          |           |
| <b>477399</b> BOOSTER   BW'S 2004 type origine avec starter<br>électrique          |            |         |         |          |          |           |
| <b>165812</b> SHA 15/15  |            |         |         |          |          |           |
| <b>479230</b> PHBN 16 BT avec dépression, graissage, starter câble                 | 72         | 34      | 50      | A02      | 210FA    |           |
| <b>462489</b> PHBN 17.5 BT avec dépression, graissage, réchauffeur                 | 93         |         |         |          |          |           |
| <b>477383</b> PHBN 17.5 BT rouge avec dépression, graissage,<br>réchauffeur        | 90         | 34      |         |          | A12      |           |
| <b>466776</b> PHVA 17.5 BX/BT 2004 5, dépression, graissage,<br>réchauffeur        | 95         | 38      |         |          | A2       |           |
| <b>473029</b> PHVA 17.5 5SD dépression, graissage, starter tirette                 | 83         | 34      |         |          | A7       |           |
| <b>466091</b> PHVA 17.5 TY dépression graissage                                    | 65         | 34      |         |          | A7       |           |
| <b>477455</b> PHVA 17.5 SENDA rouge  | 83         | 34      |         |          | A7       |           |
| <b>477454</b> PHVA 17.5 BUXY   SPEEDFIGHT rouge                                    | 95         | 38      |         |          | A2       |           |
| <b>478707</b> PHVA 17.5 BOOSTER   BW'R   NITRO   AEROX 2004->  <br>SPEEDFIGHT      |            |         |         |          |          |           |



481466



477399



165812



479230



462489



477383



466776



473029



466091



477455



477454



478707

# CARBURATION / CARBURATION

MOTEUR

**GURTNER**

## CARBURATEUR

|        |                           |       |
|--------|---------------------------|-------|
| 494770 | 103 SP   MVL              | Ø12mm |
| 495699 | 103 VOGUE   102           | Ø12mm |
| 494768 | MBK 51V   51S moteur AV10 |       |
| 494769 | MBK 88 AV7                | Ø12mm |



**TEKNIX**  
Original Quality Carburetors

## CARBURATEUR

|        |   |
|--------|---|
| 622    | 103 SP   MVL                                |
| 466775 | 103 SPX   RCX   VOGUE VS2                   |
| 466314 | 103 VOGUE   103 Z                           |
| 4031   | MBK 51V   51S moteur AV10                   |
| 4035   | MBK 88 AV7                                  |
| 480419 | PEUGEOT TREKKER   SPEEDFIGHT   BUXY   KYMCO |



Sélection  
**CGN**

## CARBURATEUR

|        |  |
|--------|--|
| 483340 | LUDIX   SPEEDFIGHT 3   TREKKER   VIVACITY 2 et 3   KYMCO Ø12mm |
| 468830 | 4 temps CHINOIS 50CC   139QMB   SYM   KYMCO   KISBEE Ø18mm     |



**polini**  
motocross

## GICLEUR (COFFRET DE 10)

PHBN/PHVA

|        |           |
|--------|-----------|
| 477568 | 60 à 78   |
| 477569 | 80 à 98   |
| 477570 | 100 à 118 |
| 477571 | 120 à 138 |
| 477572 | 140 à 158 |
| 477573 | 160 à 178 |
| 477574 | 180 à 198 |

PHBG/SHA

|        |           |
|--------|-----------|
| 477563 | 60 à 78   |
| 477564 | 80 à 89   |
| 477565 | 90 à 99   |
| 477566 | 100 à 109 |
| 477567 | 110 à 128 |

MIKUNI

|        |           |
|--------|-----------|
| 477581 | 130 à 175 |
| 477582 | 180 à 270 |
| 477583 | 280 à 370 |

POLINI/KE IHIN

|        |           |
|--------|-----------|
| 484274 | 60 à 78   |
| 484275 | 80 à 98   |
| 477575 | 100 à 118 |
| 477576 | 120 à 138 |
| 477577 | 140 à 158 |
| 477578 | 160 à 178 |
| 477579 | 180 à 198 |





**GICLEUR (COFFRET)**

|        |                      |                    |     |
|--------|----------------------|--------------------|-----|
| 483337 | PWK   OKO            | 35 à 58            | x10 |
| 472623 | PHBG   SHA           | 50 à 72            | x10 |
| 466752 | PHBG   SHA           | 60 à 120 de 5 en 5 | x72 |
| 466753 | KEIHIN   GURTNER     | 70 à 94 de 2 en 2  | x72 |
| 466751 | PHBN   PHVA          | 70 à 120 de 5 en 5 | x72 |
| 483338 | CVK 5mm 4 temps 50CC | 75 à 98            | x10 |
| 472624 | PHBG   SHA           | 75 à 98            | x10 |
| 472626 | PHBN   PHVA          | 75 à 98            | x10 |
| 472625 | PHBG   SHA           | 100 à 122          | x10 |
| 472627 | PHBN   PHVA          | 100 à 122          | x10 |
| 475687 | PWK   OKO            | 100 à 122          | x10 |
| 475688 | PWK   OKO            | 125 à 148          | x10 |
| 483336 | PWK   OKO            | 150 à 172          | x10 |

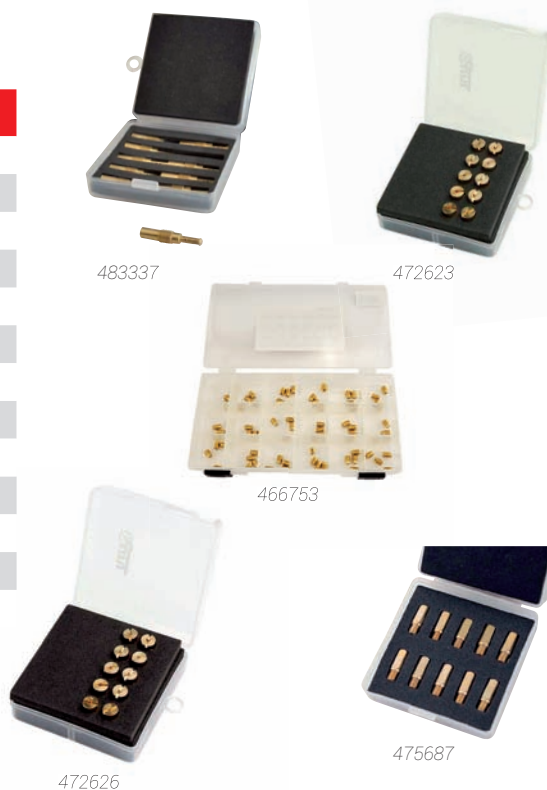

**GURTNER**

**GICLEUR (X1)**

|        |    |
|--------|----|
| 476735 | 50 |
| 476736 | 52 |
| 476739 | 54 |
| 476740 | 56 |
| 476741 | 58 |
| 458950 | 60 |
| 476742 | 62 |
| 455022 | 64 |
| 455024 | 66 |
| 455025 | 68 |
| 455026 | 70 |
| 455027 | 72 |
| 455029 | 74 |
| 455030 | 76 |
| 455032 | 78 |
| 455034 | 80 |
| 455035 | 82 |
| 455036 | 84 |
| 455037 | 86 |
| 455038 | 88 |
| 455039 | 90 |
| 455040 | 92 |



Sélection  
**CGN**

**GICLEUR 4 TEMPS  
GY6/139 QMB  
ØMM (X1)**

|        |     |
|--------|-----|
| 484996 | 80  |
| 484997 | 82  |
| 484998 | 85  |
| 484999 | 88  |
| 485000 | 90  |
| 485001 | 92  |
| 485002 | 95  |
| 485003 | 98  |
| 484993 | 100 |
| 484994 | 103 |
| 484995 | 105 |



# CARBURATION / CARBURATION

MOTEUR



## PIÈCES CARBURATEUR

- 473258 coude guide câble SHA (jeu)
- 494455 BOOSTER | BW'S 2004-> joint, vis, flotteur
- 493928 PEUGEOT TREKKER | SPEEDFIGHT | BUXY | KYMCO | BOOSTER
- 487826 kit de réparation 125 CC 4 temps chinois,GY6, 13 pièces



## PIÈCES CARBURATEUR

- 473464 cuve PHBG plastique transparent avec joint et vis
- 473465 cuve PHVA plastique transparent



## PIÈCES CARBURATEUR

- 482139 coude 250°



## PIÈCES CARBURATEUR

- 484326 raccord, connecteur en T pour durite essence/air Ø6mm
- 494136 raccord en T pour durite essence/air Ø8mm



## PIÈCES CARBURATEUR

- 10179 joint de carburateur 103
- 18718 vis épaulée de carburateur
- 495807 joint de cuve MBK 88 AV7









## STARTER AUTOMATIQUE

- 482020 scooter pour carburateur 477399/TK
- 484643 scooter type GURTNER TREKKER
- 297007 scooter PHVA moteur MINARELLI | MORINI type DELLORTO
- 296948 scooter PHVA AEROX | NITRO type DELLORTO
- 482021 scooter PHVA PIAGGIO type DELLORTO



## STARTER MANUEL

|        |                               |   |
|--------|-------------------------------|---|
| 477584 | avec câble, complet, bleu     |  |
| 477585 | sans câble, chrome            |  |
| 460573 | avec câble, complet           |  |
| 482746 | universel                     |  |
| 472621 | kit starter à câble pour PHVA |  |
| 472622 | PHVA BX   TY   SD à gachette  |  |
| 473466 | PHBN, à câble, complet        |  |



477585

472622

### INFO TECHNIQUE

Retrouvez les bouchons d'essence **page 385**.



## KIT DE RÉPARATION

|        |  |           |
|--------|--|-----------|
| 487823 | TK et type PHVA origine MBK   YAMAHA   PEUGEOT | 14 pièces |
| 487824 | PEUGEOT   HONDA   SYM 2 temps origine          | 15 pièces |
| 487825 | 50CC 4 temps CHINOIS   GY6 (13 PCS)            | 13 pièces |
| 472628 | PHVA ou PHBN                                   |           |

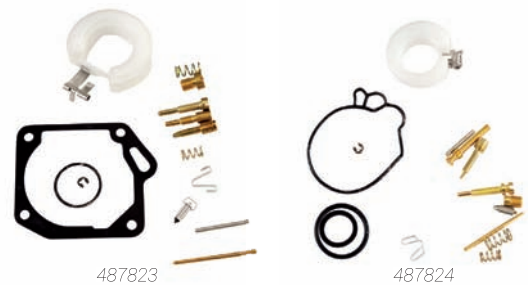

487823

487824



487825

472628

## MANCHON

|        |  |   |
|--------|--|---|
| 291582 | BOOSTER   SPEEDFIGHT   SR50   NITRO        |  |
| 293370 | TYPHOON   103   51 MBK 24/24               |  |
| 460578 | 29/34                                      |  |
| 177    | PHBG 24/24                                 |  |
| 477452 | PEUGEOT PHBN   PHVA BUXY   FIGHT   TREKKER |  |
| 477451 | universel 24/24                            |  |
| 497484 | DERBI SENDA EURO 3 (OEM 871319)            |  |



291582

293370

460578

177

477452

477451

497484





## ROBINET ESSENCE

|        |  |                                 |
|--------|--|---------------------------------|
| 247557 | BOOSTER SPIRIT   BW'S ->2003               |                                 |
| 252279 | NITRO   TYPHOON   PEUGEOT   ZIP   BOOSTER  |                                 |
| 252719 | BOOSTER NG ->1999                          |                                 |
| 479168 | LUDIX                                      | Ø15mm, manuel, made in CEE      |
| 479169 | LUDIX   VIVACITY                           | Ø15mm, dépression               |
| 484559 | ZIP 2 temps 2008->                         | dépression                      |
| 466576 | RUNNER 2003->                              |                                 |
| 483301 | CPI   SCOOTER CHINOIS                      | 14x1.5mm                        |
| 481602 | SCOOTER CHINOIS                            | 14x1.00mm, dépression, à visser |
| 484645 | SCOOTER CHINOIS                            | réservoir plastique 4 sorties   |
| 481521 | KYMCO   SCCOTER CHINOIS                    | dépression, à visser            |
| 484650 | DAX  | 3 sorties                       |
| 483299 | DERBI SENDA   PIAGGIO   PEUGEOT            |                                 |
| 483299 | DERBI SENDA   PIAGGIO   PEUGEOT            |                                 |
| 481743 | RIEJU RR   MRX   SMX   SPIKE   MATRIX      |                                 |
| 484644 | universel                                  | Ø6mm                            |
| 634    | 103 réservoir 3L7 et 101   102   104   105 |                                 |
| 449770 | 103 réservoir 5L FOX   MVL   VOGUE   RCX   | Ø12mm                           |
| 4068   | MBK 51                                     | indicateur de position          |
| 484519 | MBK 51                                     | avec renfort et indicateur      |
| 4069   | MBK 88                                     |                                 |
| 462500 | universel                                  | Ø6mm                            |
| 483302 | universel                                  | Ø7mm                            |
| 483767 | universel                                  | Ø8mm                            |

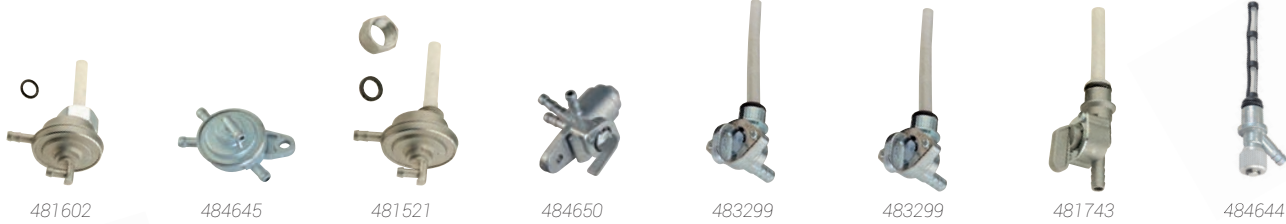



## ROBINET ESSENCE

**478748** universel, racing ON/OFF, suppression de la dépression, Ø intérieur 8mm



## ROBINET ESSENCE

- 3201** CIAO PX | PUCH made in CEE
- 480233** NITRO | TYPHOON | PEUGEOT | ZIP dépression
- 483721** à vis, Øfixation 10mm pour durite de 6mm
- 485123** universel avec fixation cadre Ø6mm
- 484521** universel avec fixation cadre Ø8mm, made in CEE
- 496617** MBK 51 made in CEE
- 496615** 103 réservoir 3L7 et 101 | 102 | 104 | 105
- 496614** 103 réservoir 3L7 et 101 | 102 | 104 | 105
- 496618** MBK 88 | AV40 | AV50 made in CEE
- 496629** BETA RR Ø8mm entraxe 34mm made in CEE
- 496616** HONDA HME | CRE made in CEE
- 496625** RIEJU RR | MRX | SMX | SPIKE made in CEE
- 496626** RIEJU RS2 | RX made in CEE
- 496628** DERBI SENDA | PIAGGIO | PEUGEOT
- 496623** LUDIX | VIVACITY Ø15mm made in CEE
- 496624** PEUGEOT VIVACITY made in CEE
- 496619** SCOOTER CHINOIS dépression, à visser
- 496620** SCOOTER CHINOIS dépression, à visser
- 496622** ZIP 2 temps 2008-> dépression, made in CEE
- 496631** universel Ø8mm, made in CEE
- 496630** universel Ø8mm avec fixation cadre, made in CEE
- 497521** réservoir huile OEM DERBI SENDA EURO 3 (OEM 00H03704081)



3201

480233



483721

485123

484521



496617

496615

496614



496618



496629



496616



496625



496626



496628



496623



496624



496619



496620



496622



496631



496630



497521



## POMPE À ESSENCE

484649 50 SCOOTER CHINOIS (GY6)



## POMPE À ESSENCE

496331 universelle



## DURITE ESSENCE 1M AVEC 5 COLLIERS

483417 5x10

483418 6x10

483419 8x13



## DURITE ESSENCE NBR 5M

491334 textile renforcé haute qualité noir 4x10

491333 textile haute qualité noir 4x9.5

493407 textile haute qualité noir 5x10

491335 acier inoxydable haute qualité noir 6x10.5



## DURITE ESSENCE 1MX5MM

483687 noir

478262 blanc

478265 gris

487293 bleu

478267 jaune fluo

478268 orange fluo

479280 rose fluo

478263 rouge

479180 transparent

478266 vert fluo

479178 violet



483687



478262



478265



487293



478267



478268



479280



478263



479180



478266



479178



**DURITE ESSENCE 10M**

|               |                        |                   |
|---------------|------------------------|-------------------|
| <b>285477</b> | 3x5mm huile et essence | jaune             |
| <b>1418</b>   | 4x7.5mm                | transparent       |
| <b>1419</b>   | 4x7.6mm                | noir              |
| <b>293881</b> | 4x7.6mm                | élastomère        |
| <b>1421</b>   | 5x8.5mm                | transparent       |
| <b>1420</b>   | 5x8.6mm                | noir              |
| <b>441906</b> | 5x8.6mm                | élastomère        |
| <b>489462</b> | 5x8.0mm                | jaune transparent |
| <b>489460</b> | 5x8.0mm                | rose transparent  |
| <b>489463</b> | 5x8.0mm                | rouge transparent |
| <b>489465</b> | 5x8.0mm                | vert transparent  |
| <b>489468</b> | 5x8.0mm                | bleu transparent  |
| <b>1422</b>   | 6x9.6mm                | noir              |
| <b>293877</b> | 6x9.6mm                | élastomère        |
| <b>320757</b> | 7x11mm                 | noir              |
| <b>320803</b> | 8x12mm                 | noir              |



285477



1418



1419



**COLLIER DURITE ESSENCE (X1)**

|               |     |
|---------------|-----|
| <b>320765</b> | 3x6 |
| <b>320770</b> | 4x7 |
| <b>320784</b> | 5x8 |
| <b>320799</b> | 6x9 |
| <b>467538</b> | 7x8 |
| <b>494796</b> | 8x9 |



**FILTRE ESSENCE**

|               |      |
|---------------|------|
| <b>477637</b> | Ø6mm |
| <b>477638</b> | Ø8mm |



Polisport

## FILTRE ESSENCE RECTANGULAIRE Ø6MM

|        |     |
|--------|-----|
| 484093 | x1  |
| 484424 | x50 |



TUN'R

## FILTRE ESSENCE

|             |   |      |
|-------------|---|------|
| 1395        | cylindrique transparent                             | Ø6mm |
| 1396        | rectangulaire transparent                           | Ø8mm |
| 270247      | conique transparent                                 | Ø8mm |
| 270251      | cylindrique transparent                             | Ø6mm |
| 270266      | cylindrique transparent/chrome                      | Ø8mm |
| 487569      | cylindrique transparent/chrome insert alu CNC noir  | Ø8mm |
| 487568      | cylindrique transparent/chrome insert alu CNC rouge | Ø8mm |
| Boîte de 50 |   |      |
| 492288      | rond  | Ø6mm |
| 492290      | rectangulaire transparent                           | Ø6mm |



1395



1396



270247



270251



270266



487569



487568



492288



492290

Sélection CGN

## FILTRE ESSENCE

|        |                          |              |
|--------|--------------------------|--------------|
| 483724 | cyclo, moto, motoculture | Ø6mm et Ø8mm |
| 484517 | embout acier             | Ø6mm         |



483724



484517

Sélection CGN

## CONNECTEUR SÉCURITÉ RAPIDE DURITE ESSENCE

|        |      |
|--------|------|
| 460034 | bleu |
|--------|------|



## PIPE D'ADMISSION / ADMISSION PIPE



### INFO TECHNIQUE

Retrouvez les manchons **page 70.**



### PIPE D'ADMISSION S2R

- 277830** BOOSTER | BW'S | STUNT | SLIDER
- 277863** NITRO | AEROX | NEOS | OVETTO | SR50 | F12 | MACH G | JOG R
- 465278** LUDIX | SPEEDFIGHT 3 | VIVACITY 3 | KISBEE | STREET ZONE
- 277844** SPEEDFIGHT | TREKKER | VIVACITY | BUXY
- 277859** TYPHOON | NRG | STALKER | DNA | SR50 ->2005 | ICE | RUNNER



277830



277863



465278



277844



277859



### PIPE D'ADMISSION TYPE ORIGINE

- 490304** BOOSTER | BW'S | STUNT | SLIDER | NG | NEXT | ROCKET
- 490306** NITRO | SR50 | F12 | OVETTO | JOG R | KEEWAY
- 490307** LUDIX | SPEEDFIGHT 3 | VIVACITY 3 | KISBEE | STREET ZONE | JET
- 490305** TYPHOON | NRG | ZIP | FLY | STALKER | RUNNER 50CC 2 temps
- 490308** CHINOIS 50CC | V CLIC | 139QMB | AGILITY 4 temps



490304



490306



490307



490305



490308



### PIPE D'ADMISSION

- 260091** BOOSTER | BW'S | STUNT | SLIDER | NG | NEXT | ROCKET
- 335597** NITRO | SR50 | F12 | OVETTO | JOG R | KEEWAY
- 466746** LUDIX | SPEEDFIGHT 3 | VIVACITY 3 | KISBEE | STREET ZONE | JET
- 270228** TYPHOON | NRG | ZIP | FLY | STALKER | RUNNER | LX | DNA 50 | 125CC
- 468835** CHINOIS 50CC | V CLIC | 139QMB | AGILITY | FIGHT3 4 temps
- 485722** PIAGGIO 50 MOTEUR 4 temps
- 497355** SPEEDFIGHT | TREKKER | VIVACITY | BUXY



260091



335597



466746



270228



468835



485722

# PIPE D'ADMISSION / ADMISSION PIPE



## PIPE D'ADMISSION

|        |   |       |
|--------|---|-------|
| 477424 | TYPHOON   NRG   DNA   ICE   STALKER                       | Ø30mm |
| 477428 | TYPHOON   NRG   DNA   ICE   STALKER                       | Ø30mm |
| 477425 | NITRO   AEROX   OVETTO   NEOS   SR   JOG R   MACH G   F12 | Ø30mm |



477424



477428



477425



## PIPE D'ADMISSION

472629 NITRO | AEROX | OVETTO | NEOS | SR50 | F12 | MACH G | JOG R | angle réglable



## JOINT PIPE D'ADMISSION

472122 4 temps CHINOIS 50CC | V CLIC | 139QMB

496101 GY6



472122



496101

PIPE D'ADMISSION / ADMISSION PIPE



PIPE D'ADMISSION

|        |  |          |
|--------|--|----------|
| 269801 | AM6  | Ø15-21mm |
| 467798 | AM6 alu avec manchon montage souple (MIKUNI) | Ø30mm    |
| 467795 | DERBI   SENDA   GPR monage souple            |          |



269801



467798



467795



PIPE D'ADMISSION

|        |   |         |
|--------|---|---------|
| 467799 | AM6 kit bride et manchon angle différent                |         |
| 477414 | AM6 livré avec adapateur                                | Ø24mm   |
| 487209 | HONDA CR80   DERBI   SENDA   GPR                        | Ø32.8mm |
| 467800 | SEDA   GPR   DERBI kit bride et manchon angle différent |         |



467799



477414



487209



467800



PIPE D'ADMISSION

|        |                        |       |
|--------|------------------------|-------|
| 477427 | AM6   DERBI orientable | Ø30mm |
|--------|------------------------|-------|



PIPE D'ADMISSION

|        |                    |       |
|--------|--------------------|-------|
| 461350 | AM6 montage rigide | Ø21mm |
|--------|--------------------|-------|





# PIPE D'ADMISSION / ADMISSION PIPE

MOTEUR



**DOPPLER**

## PIPE D'ADMISSION ER2

|        |                       |
|--------|-----------------------|
| 365641 | 103 montage souple    |
| 365952 | 51 MBK montage souple |



365641



365952

**TEKNIX**  
Original Quality Controller

## PIPE D'ADMISSION

|        |   |          |
|--------|---|----------|
| 496075 | PEUGEOT 103 MVL   SP   VOGUE type origine | Ø12mm    |
| 1399   | PEUGEOT 103 SP   MVL                      | Ø15mm    |
| 1400   | PEUGEOT 103 SP   MVL                      | Ø15-17mm |
| 1402   | PEUGEOT 103 SPX   RCX                     | Ø15mm    |
| 1415   | MBK 51 coudé                              | Ø15mm    |
| 1414   | MBK 51 coudé                              | Ø17-19mm |
| 1408   | MBK 51 droit                              | Ø15mm    |
| 1411   | MBK 51 droit                              | Ø17-19mm |
| 491390 | MBK 88   89   AV7                         | Ø12mm    |
| 1412   | MBK 88   89   AV7                         | Ø15mm    |



496075



1399



1400



1402



1415



1414



1408



1411



491390



1412

**polini**  
motocross

## PIPE D'ADMISSION

|      |               |          |
|------|---------------|----------|
| 2422 | 103 SPX   RCX | Ø15mm    |
| 2423 | 103 SPX   RCX | Ø17-19mm |



2422



2423



**DOPPLER**

**CLAPET S2R FIBRE RENFORCÉE**

|        |   |
|--------|---|
| 231756 | BOOSTER   BW'S   STUNT   SLIDER   ROCKET   NG               |
| 231775 | NITRO   AEROX   SR50   F12   NEOS   OVETTO   JOG R   MACH G |
| 460944 | LUDIX   JET   KISBEE   SPEED FIGHT 3   VIVACITY 2008->      |
| 231741 | SPEEDFIGHT   TREKKER   VIVACITY                             |
| 231767 | TYPHOON   NRG   STALKER   ZIP   DNA   ICE   SR50 2005->     |



**DOPPLER**

**CLAPET S3R CARBONE**

|        |   |
|--------|---|
| 365130 | BOOSTER   BW'S   STUNT   SLIDER   ROCKET   NG               |
| 365159 | NITRO   AEROX   SR50   F12   NEOS   OVETTO   JOG R   MACH G |
| 494809 | LUDIX   JET   KISBEE   SPEEDFIGHT 3   VIVACITY 2008->       |
| 365144 | SPEEDFIGHT   TREKKER   VIVACITY                             |
| 365163 | TYPHOON   NRG   STALKER   ZIP   DNA   SR50 2005->           |

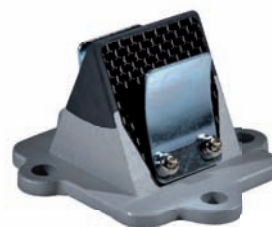

**DOPPLER**

**BOÎTE À CLAPET SIR**

|        |  |
|--------|--|
| 333135 | BOOSTER   BW'S   STUNT   SLIDER   ROCKET   NEXT   NG |
|--------|--|



**MALLOSI**

**CLAPET CARBONE**

|        |   |
|--------|---|
| 2820   | BOOSTER   BW'S   STUNT   SLIDER   ROCKET                                    |
| 482141 | NITRO   AEROX   SR50   F12   OVETTO   NEOS   MACH G   JOGR   2 lamelles 45° |
| 287378 | NITRO   AEROX   SR50   F12   OVETTO   NEOS   MACH G   JOGR   4 lamelles     |
| 287382 | NRG   TYPHOON   STALKER   RUNNER   DNA   ICE   ZIP   SR50 2005->            |



**polini**

**CLAPET**

|        |   |
|--------|---|
| 450478 | BOOSTER   BW'S   STUNT   SLIDER   ROCKET                    |
| 333006 | NITRO   AEROX   SR50   F12   OVETTO   NEOS   MACH G   JOG R |
| 486807 | VESPA 50-125  |



# CLAPET / REED VALVE

MOTEUR



## BOÎTE À CLAPET

1358 BOOSTER | BW'S | STUNT | SLIDER | ROCKET Ø21mm



## CLAPET

- 460566 BOOSTER | BW'S | STUNT | SLIDER | ROCKET
- 460567 NITRO | AEROX | SR50 | F12 | OVETTO | NEOS | MACH G | JOG R
- 468134 NITRO | AEROX | SR50 | F12 | OVETTO | NEOS | MACH G | JOG R 8 lamelles
- 460569 SPEEDFIGHT | TREKKER | VIVACITY | BUXY
- 460568 TYPHOON | NRG | STALKER | ZIP | ICE | DNA | SR50 2005->



## CLAPET

- 265184 BOOSTER | BW'S | STUNT | SLIDER | ROCKET
- 335601 NITRO | AEROX | OVETTO | NEOS | MACH G | JOG R | F 12 | SR | KEEWAY
- 462535 LUDIX | VIVACITY 3 | SPEEDFIGHT 3 | JET C TECK | KISBEE | DJANGO
- 335616 SPEEDFIGHT | TREKKER | VIVACITY | BUXY
- 270156 TYPHOON | NRG | STALKER | ZIP | ICE | DNA | SR50 2005->



## CLAPET FIBRE

468251 BOOSTER | BW'S | STUNT | SLIDER | ROCKET type BOYSEN



## BOÎTE À CLAPET

- 467412 BOOSTER | BW'S | STUNT | SLIDER | ROCKET | NG
- 462491 SPEEDFIGHT | TREKKER | BUXY | TKR | ZENIT





**DOPPLER**

**JOINT BOÎTE À CLAPET**

440681 BOOSTER | BW'S | STUNT | SLIDER | ROCKET | NEXT



**ARTEIN**  
gaskets

**JOINT CLAPET**

|        |   |             |
|--------|---|-------------|
| 482777 | LUDIX   JET FORCE   SPEEDFIGHT 3   KISBEE 2 temps   VIVACITY 2008-> | côté carter |
| 482775 | BUXY   SPEEDFIGHT   TREKKER   VIVACITY 2 air et liquide             | côté carter |



482777



482775

**TEKNIX**  
Original Quality Controller

**JOINT CLAPET/PIPE**

|        |   |             |    |
|--------|---|-------------|----|
| 484337 | BUXY   SPEEDFIGHT   TREKKER   VIVACITY                                | côté carter |    |
| 484338 | BUXY   SPEEDFIGHT   TREKKER   VIVACITY                                | côté pipe   |    |
| 479368 | BUXY   SPEEDFIGHT   TREKKER   VIVACITY                                | côté pipe   | x2 |
| 479369 | ZIP   TYPHOON   STALKER   RUNNER   FLY   SR 50 2005->   NRG   2 temps | côté carter | x2 |
| 472122 | CHINOIS 50CC   V CLIC   139QMB 4 temps                                | côté pipe   |    |
| 4138   | BOOSTER   BW'S   STUNT   SLIDER   ROCKET   NG                         | côté carter |    |
| 481340 | NITRO   AEROX   MACH G   JOG R   NEOS   OVETTO   F 12   SR            |             |    |



484337



479368



472122



481340



484338



479369



4138

**DOPPLER**

**LAMELLE DE CLAPET S2R FIBRE POUR CLAPET D'ORIGINE**

|        |   |
|--------|---|
| 440164 | BOOSTER   BW'S   STUNT   SLIDER   ROCKET   NG               |
| 440166 | NITRO   AEROX   OVETTO   NEOS   MACH G   JOGR SR50   F12    |
| 440165 | SPEEDFIGHT   TREKKER   VIVACITY   BUXY   TRR                |
| 440176 | TYPHOON   NRG   STALKER   RUNNER   SR 50 2005->   ICE   DNA |





**DOPPLER**

## LAMELLE DE CLAPET S2R FIBRE

|        |   |  |  |
|--------|---|--|--|
| 468222 | clapet DOPPLER S2R   NITRO   LUDIX   TYPHOON                |  |  |
| 468221 | clapet DOPPLER S2R BOOSTER   BW'S   STUNT   SLIDER   ROCKET |  |  |



**DOPPLER**

## LAMELLE DE CLAPET SR3 CARBONE HI-TECH POUR CLAPET D'ORIGINE

|        |  |  |  |
|--------|--|--|--|
| 284728 | BOOSTER   BW'S   STUNT   SLIDER   ROCKET                         |  |  |
| 284732 | NITRO   AEROX   OVETTO   NEOS   MACH G   JOG R   SR50   F12      |  |  |
| 284751 | SPEEDFIGHT   TREKKER   VIVACITY   BUXY                           |  |  |
| 284747 | TYPHOON   NRG   STALKER   ZIP   SR50 2005->   RUNNER   DNA   ICE |  |  |

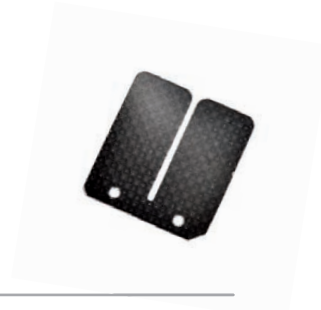

**polini**  
motocross

## LAMELLE DE CLAPET CARBONE (X1)

|      |   |  |  |
|------|---|--|--|
| 2825 | BOOSTER   BW'S   STUNT   ROCKET                             |  |  |
| 2824 | NITRO   AEROX   SR50   F12   OVETTO   NEOS   MACH G   JOG R |  |  |



**DOPPLER**

## LAMELLE BOÎTE À CLAPET SIR

|        |  |  |  |
|--------|--|--|--|
| 440160 | BOOSTER   BW'S   STUNT   SLIDER   ROCKET |  |  |
|--------|--|--|--|



**MALOSSI**

## FEUILLE CARBONE POUR LAMELLE DE CLAPET 100X100MM (X2)

|        |                  |  |  |
|--------|------------------|--|--|
| 482135 | épaisseur 0.30mm |  |  |
| 482136 | épaisseur 0.35mm |  |  |
| 482137 | épaisseur 0.40mm |  |  |



**DOPPLER**

## CALE D'ADMISSION AVEC VIS

|        |                               |     |       |
|--------|-------------------------------|-----|-------|
| 494634 | AM6   DERBI SENDA EURO 2 et 3 | 5mm | noir  |
| 494635 | AM6   DERBI SENDA EURO 2 et 3 | 5mm | rouge |





**CLAPET ER2 FIBRE RENFORCÉE**

|        |   |
|--------|---|
| 279479 | AM6                                       |
| 208471 | SENDA   GPR   RS   RS4   SMT   RCR   RX50 |



**CLAPET ER3 CARBONE**

|        |   |
|--------|---|
| 365091 | AM6   |
| 365106 | DERBI SENDA   GPR   RS   RS4   SMT   RCR   RX50 |



**CLAPET**

|        |     |            |
|--------|-----|------------|
| 460529 | AM6 | carbone    |
| 468135 | AM6 | 8 lamelles |



**CLAPET**

|        |   |
|--------|---|
| 449775 | AM6   |
| 480755 | AM6   SENDA   GPR   RS   RS4   SMT   RCR   RX   DERBI 4 lamelles fibre de verre |
| 483330 | SUZUKI RMX   SMX 50   |



**JOINT CLAPET**

|        |                                       |           |
|--------|---------------------------------------|-----------|
| 450117 | AM6                                   | côté pipe |
| 450119 | AM6 pour clapet DOPPLER               |           |
| 450120 | DERBI SENDA   GPR pour clapet DOPPLER |           |



**JOINT CLAPET**

|        |   |                     |
|--------|---|---------------------|
| 482058 | AM6   | côté carter         |
| 482056 | DERBI   SENDA   GPR EURO 2 EURO 3                             | côté carter         |
| 482057 | DERBI SENDA   GPR   RS   RS4   RX   SMT   RCR   EURO 2 EURO 3 | côté carter et pipe |





**ARTEIN**

## JOINT CLAPET

|        |   |                     |
|--------|---|---------------------|
| 482058 | AM6   | côté carter         |
| 482056 | DERBI   SENDA   GPR EURO 2 EURO 3                             | côté carter         |
| 482057 | DERBI SENDA   GPR   RS   RS4   RX   SMT   RCR   EURO 2 EURO 3 | côté carter et pipe |



Sélection  
**CGN**

## JOINT CLAPET/PIPE

|        |   |           |    |
|--------|---|-----------|----|
| 479367 | AM6   | côté pipe | x2 |
| 479366 | DERBI SENDA   GPR   RS   RS4   RX   SMT   RCR   EURO 2 EURO 3 | côté pipe | x2 |
| 329050 | DERBI SENDA   GPR   RS   RS4   RX   SMT   RCR   EURO 2 EURO 3 |           |    |



**DOPPLER**

## LAMELLE DE CLAPET ER2 FIBRE POUR CLAPET D'ORIGINE

|        |     |
|--------|-----|
| 440167 | AM6 |
|--------|-----|



**DOPPLER**

## LAMELLE DE CLAPET ER2 FIBRE

|        |   |
|--------|---|
| 468219 | clapet DOPPLER ER2  AM6                                       |
| 468220 | DERBI SENDA   GPR   RS   RS4   RX   SMT   RCR   EURO 2 EURO 3 |



**DOPPLER**

## LAMELLE DE CLAPET ER3 CARBONE HI-TECH POUR CLAPET D'ORIGINE

|        |   |
|--------|---|
| 284766 | AM6   |
| 284777 | DERBI SENDA   GPR   RS   RS4   RX   SMT   RCR   EURO 2 EURO 3 |



**polini**

## LAMELLE DE CLAPET CARBONE POUR CLAPET ORIGINE

|        |   |
|--------|---|
| 440182 | DERBI SENDA   GPR   RS   RS4   RX   SMT   RCR   EURO 2 EURO 3 |
|--------|---|



**MALOSSI**

## FEUILLE CARBONE POUR LAMELLE DE CLAPET 100X100MM (X2)

|        |           |                  |
|--------|-----------|------------------|
| 482135 | 100x100mm | épaisseur 0.30mm |
| 482136 | 100x100mm | épaisseur 0.35mm |
| 482137 | 100x100mm | épaisseur 0.40mm |





**CLAPET ER2 FIBRE RENFORCÉE**

247766 103 MVL | SPX | VOGUE | RCX | SP | TOMOS



**CLAPET ER3 CARBONE**

365117 103 MVL | VOGUE | SP | SPX | RCX | TOMOS



**CLAPET CARBONE**

461242 103 CARTER MALOSSİ

461248 MBK 51



**CLAPET CARBONE**

488080 MBK 51



**BOÎTE À CLAPET**

1344 103 SP | MVL Ø15mm

1345 103 SP | MVL Ø17-19mm

1355 MBK 51 Ø17-19mm



1344



1345



1355





## CLAPET DE BOÎTE À CLAPET

1372 103 | MBK 51 | 103 carter sans support moteur intégré

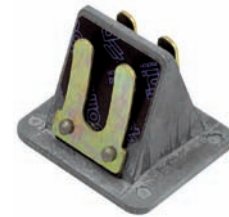

## PIPE DE BOÎTE À CLAPET

|      |  |          |
|------|--|----------|
| 1367 | 103 SP   MVL   VOGUE sans support moteur intégré | Ø15mm    |
| 2419 | 103 SP   MVL sans support moteur intégré         | Ø17-19mm |



1367



2419



## CLAPET

|        |                          |
|--------|--------------------------|
| 635    | 103                      |
| 4067   | MBK 41   51 (AV 10)      |
| 493100 | 103 FOX   FXR   WALLAROO |



635



4067



493100



## JOINT CLAPET/PIPE

|      |                      |
|------|----------------------|
| 636  | 103 côté pipe        |
| 4064 | MBK 51 côté pipe     |
| 4065 | MBK 88 AV7 côté pipe |
| 638  | 103   TOMOS          |
| 4066 | MBK 51               |



636



4064



4065



638



4066



## FEUILLE CARBONE POUR LAMELLE DE CLAPET 100X100MM (X2)

|        |                  |
|--------|------------------|
| 482135 | épaisseur 0.30mm |
| 482136 | épaisseur 0.35mm |
| 482137 | épaisseur 0.40mm |





## CARTER MOTEUR DROIT

**467306** BOOSTER | BW'S ->2004 | STUNT | SLIDER | ROCKET | NG

## CARTER / CASING



## CARTER MOTEUR DROIT

**451083** BOOSTER | BW'S ->2004 | STUNT | SLIDER | ROCKET | NG

**451084** NITRO | AEROX | OVETTO | NEOS | SR50 | F12 | MACH G

**482745** TREKKER | TKR | VIVACITY | SPEEDFIGHT ->2007 (736411)

La référence 482745 est adaptable aussi sur LOOXSOR ELYSTAR, modèle sans pompe à air, pour pompe à huile mécanique 2 fixations, avec silentbloc long avec roulement et spi.



451083



451084



482745



## JOINT DE CARTER MOTEUR

**467722** SCOOTER CHINOIS 4 temps

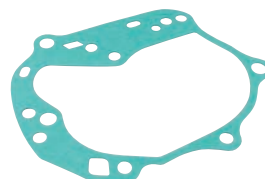



**ARTEIN**  
gaskets

**JOINT DE CARTER MOTEUR**

482771 LUDIX | SPEEDFIGHT 3 | VIVACITY 3 | KISBEE 2 temps air et liquide

482768 SPEEDFIGHT | BUXY | TREKKER | TKR | VIVACITY 2 air

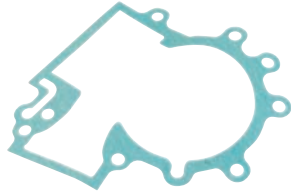

482771

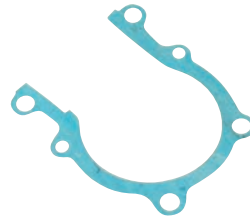

482768

**ARTEIN**  
gaskets

**JOINT DE CARTER ALLUMAGE**

484135 BOOSTER | BW'S | STUNT | SLIDER | ROCKET | NEXT | NG

484555 NITRO | AEROX | OVETTO | NEOS



484135



484555



**INFO + :**

Retrouvez les carters allumages avec la carrosserie **page 315**.

**JOINT DE CARTER EMBRAYAGE**

460632 AM6



475683 AM6



482055 DERBI SENDA | GPR 2006-> EURO 3



479920 DERBI SENDA | GPR | FENIX 2006-> EURO 3



482054 DERBI SENDA | GPR | ->2006 EURO 2



460632

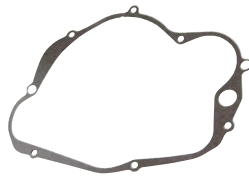

475683

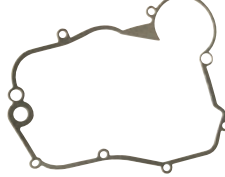

482055

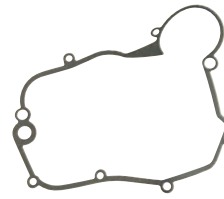

479920



482054



## JOINT DE CARTER MOTEUR

479921 DERBI SENDA | GPR 2006-> EURO 3

329045 DERBI SENDA | GPR | FENIX ->2006 EURO 2

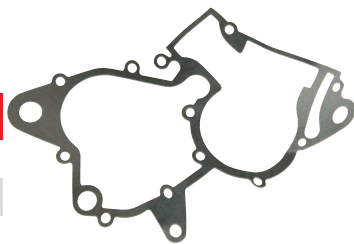

479921

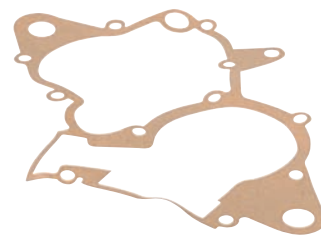

329045



## JOINT DE CARTER ALLUMAGE

484768 AM6

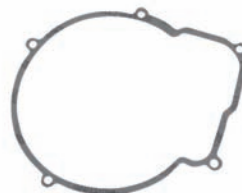

**INFO + :**  
Retrouvez les pâtes à joints dans **la famille Atelier.**



## CARTER MOTEUR

2405 103 SP | MVL | SPX | RCX complet sans support moteur

2412 MBK 51 complet

Joint

2348 joint de carter avec support 103

2347 joint de carter sans support 103

2350 joint de carter 51



2405



2412

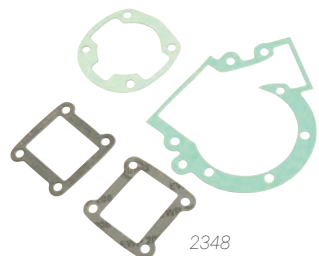

2348



2347

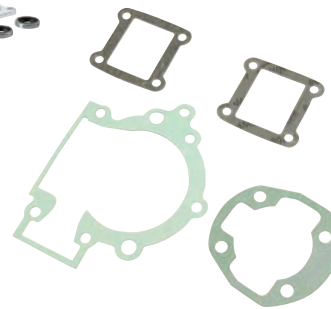

2350



## PIÈCES DÉTACHÉES DE CARTER MOTEUR

|      |                       |                       |                     |
|------|-----------------------|-----------------------|---------------------|
| 2420 | pipe carter moteur    | 103 SP   SPX D15      | carter avec support |
| 2421 | pipe carter moteur    | 103 SP   SPX D17   19 | carter avec support |
| 2419 | pipe carter moteur    | 103 SP   MVL D17   19 | carter sans support |
| 1372 | clapet boite à clapet | 103   MBK51           | carter sans support |



2420



2421



2419

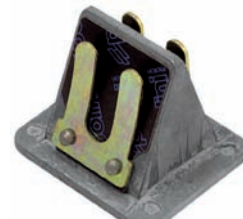

1372



## CARTER MOTEUR TYPE ORIGINE

|        |             |   |
|--------|-------------|---|
| 168300 | 103         | avec joint carter/SPI, goujons, roulements et boulons |
| 188763 | MBK 51 AV10 | avec joint carter/SPI, goujons, roulements et boulons |
| 206828 | MBK 88 AV7  | avec joint carter/SPI, goujons, roulements et boulons |



168300



188763



206828



## CARTER / CASING

### PIÈCES DÉTACHÉES DE CARTER MOTEUR

|        |                                      |                       |
|--------|--------------------------------------|-----------------------|
| 685    | joint de carter                      | 103                   |
| 4130   | joint de carter moteur AV10          | MBK 51   41           |
| 4131   | joint de carter moteur AV7           | 88 MBK                |
| 491129 | axe moteur écrou 10x1.25             | 103 SP   MVL   CHRONO |
| 4292   | axe moteur écrou 8x137               | MBK 51                |
| 4288   | flexibloc bas moteur                 | MBK 51                |
| 4291   | flexibloc haut moteur (x1)           | MBK 51                |
| 485347 | rondelle   bague support moteur (x1) | 103                   |
| 168295 | support moteur                       | 103 SP   MVL          |
| 491131 | support biellette                    | 103 SP   RCX          |



685



4130

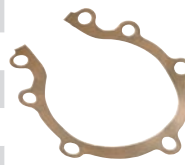

4131



491129



4292



4288



4291



485347



168295



491131



### MOTEUR

|        |                       |   |
|--------|-----------------------|---|
| 490509 | 103 MVL   SP   CHRONO | avec variateur et allumage électronique |
| 490510 | MBK AV10              | avec variateur                          |
| 497773 | MBK AV7               | avec variateur                          |
| 497774 | MBK AV7               | sans variateur avec embrayage           |



490509



490510



497773



**DOPPLER**

## EMBIELLAGE ENDURANCE

|        |  |                  |
|--------|--|------------------|
| 441277 | BOOSTER   BW'S   STUNT   SLIDER                                    | axe piston 10mm  |
| 441278 | BOOSTER   BW'S   STUNT   SLIDER                                    | axe piston 12mm  |
| 441280 | NITRO   AEROX   NEOS   MACH G   JOG R   OVETTO   SR50   F12        | axe piston 10mm  |
| 449885 | NITRO   AEROX   NEOS   MACH G   JOG R   OVETTO   SR50   F12        | axe piston 12 mm |
| 464917 | LUDIX   VIVACITY 3   SPEEDFIGHT 3   KISBEE 2 temps                 | pour pompe à air |
| 441279 | SPEEDFIGHT I   TREKKER   BUXY   VIVACITY                           |                  |
| 468200 | SPEEDFIGHT II   TKR   TREKKER   VIVACITY 2                         | pour pompe à air |
| 441281 | ZIP   TYPHOON   NRG   FLY   STALKER   RUNNER 2 temps   SR50 2005-> |                  |
| 472300 | KEEWAY   CPI   | axe piston 12mm  |



**DOPPLER**

## EMBIELLAGE SIR

|        |   |                  |
|--------|---|------------------|
| 263913 | BOOSTER   BW'S   STUNT   SLIDER                     | axe piston 10mm  |
| 263947 | NITRO   AEROX   SR50   F12   NEOS   OVETTO          | axe piston 10mm  |
| 464918 | LUDIX   SPEEDFIGHT 3   VIVACITY 3   KISBEE 2 temps  | pour pompe à air |
| 263928 | SPEEDFIGHT 1   TKR   TREKKER   BUXY   VIVACITY      |                  |
| 468199 | SPEEDFIGHT 2   TKR   TREKKER   VIVACITY 2           | pour pompe à air |
| 263932 | TYPHOON   NRG   STALKER   ICE   DNA   RUNNER   SR50 |                  |
| 468384 | KEEWAY   CPI  | axe piston 10mm  |
| 472301 | KEEWAY   CPI  | axe piston 12mm  |

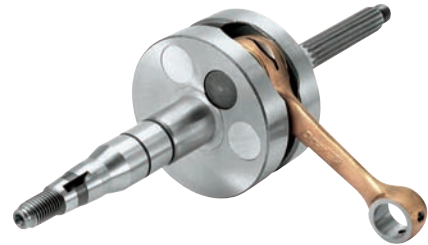

**DOPPLER ORIGIN**

## EMBIELLAGE ORIGINE

|        |   |                 |
|--------|---|-----------------|
| 486143 | BOOSTER   BW'S   STUNT   SLIDER                         | axe piston 10mm |
| 486141 | NITRO   AEROX   OVETTO   NEO   SR50   F12               | axe piston 10mm |
| 486142 | NITRO   AEROX   OVETTO   NEO   SR50   F12               | axe piston 12mm |
| 486144 | TYPHOON   NRG   STALKER   ZIP   ICE   DNA   SR50 2005-> |                 |



**polini**  
motociclisti

## EMBIELLAGE FOR RACE

|        |   |                 |
|--------|---|-----------------|
| 495294 | BOOSTER   BW'S   STUNT   ROCKET                         | axe piston 10mm |
| 495295 | NITRO   AEROX   SR50   F12   OVETTO   NEOS   MACH G     | axe piston 10mm |
| 495296 | TYPHOON   NRG   STALKER   ICE   DNA   ZIP   SR50 2005-> | axe piston 10mm |
| 486144 | TYPHOON   NRG   STALKER   ZIP   ICE   DNA   SR50 2005-> |                 |





## EMBIELLAGE / CRANKSHAFT

### EMBIELLAGE

|        |  |                  |
|--------|--|------------------|
| 4119   | BOOSTER   BW'S   STUNT   SLIDER   ROCKET   NEXT                            | axe piston 10mm  |
| 248743 | NITRO   AEROX   SR50   F12   OVETTO   NEOS   MACH G                        | axe piston 10mm  |
| 460010 | LUDIX   VIVACITY 3   JET F   SPEEDFIGHT 3                                  | pour pompe à air |
| 472650 | SPEEDFIGHT 2   TREKKER   TKR   VIVACITY 2                                  | pour pompe à air |
| 194909 | SPEEDFIGHT   TREKKER   BUXY ->2006   |                  |
| 168507 | TYPHOON   NRG   STALKER   ICE   DNA   ZIP   SR50 2005->                    |                  |
| 483400 | ZIP   FLY   VESPA LX   LIBERTY 4 temps ->2008                              |                  |
| 467405 | KEEWAY   CPI   | axe piston 12mm  |
| 467406 | KYMCO AGILITY   VITALITY   COBRA   PEOPLE   DNK   TOP BOY   SNIPER 2 temps |                  |
| 478391 | SYM EUROJET 50 2 temps   |                  |
| 472543 | CHINOIS 139QMB   GY6   V-CLIC   BAOTIAN 4 temps                            | axe piston 13mm  |
| 494099 | PEUGEOT KISBEE   DJANGO   SYM FIDDLE 2 4 temps                             | axe piston 10mm  |



### EMBIELLAGE

|        |   |   |
|--------|---|---|
| 460581 | BOOSTER   BW'S   STUNT   ROCKET                         | axe piston 10mm                                 |
| 495484 | BOOSTER   BW'S   STUNT   ROCKET                         | axe piston 10mm<br>avec roulements et joint SPI |
| 460582 | NITRO   AEROX   SR50   F12   MACH G   OVETTO   NEOS     |   |
| 495486 | NITRO   AEROX   SR50   F12   MACH G   OVETTO   NEOS     | avec roulements et joint SPI                    |
| 460584 | SPEEDFIGHT   TREKKER   BUXY                             |   |
| 495487 | SPEEDFIGHT   TREKKER   BUXY                             | avec roulements et joint SPI                    |
| 460583 | TYPHOON   NRG   STALKER   ZIP   ICE   DNA   SR50 ->2005 |   |
| 495488 | TYPHOON   NRG   STALKER   ZIP   ICE   DNA   SR50 ->2005 | avec roulements et joint SPI                    |



### EMBIELLAGE ENDURANCE

|        |   |
|--------|---|
| 367223 | AM6 montage avec deux roulements 6204 non inclus              |
| 468210 | DERBI GPR   SENDA   RS50   RS4   RX   SMT   RCR EURO 3 2006-> |
| 367238 | DERBI SENDA EURO 2 ->2006                                     |
| 441282 | GPR EURO 2  |







**DOPPLER**

## EMBIELLAGE ERI

|        |   |
|--------|---|
| 264006 | AM6   |
| 367443 | DERBI GPR EURO 2  |
| 468209 | DERBI GPR   SENDA   RS50   RS4   RX50   SMT   RCR EURO 3 2006-> |
| 263990 | DERBI SENDA EURO 2 ->2006                                       |



**DOPPLER** ORIGIN

## EMBIELLAGE ORIGIN

|        |  |
|--------|--|
| 486138 | AM6 montage avec roulements 6303 et 6204 non inclus      |
| 486140 | DERBI GPR   SENDA   RS50   RS4   RX50   SMT   RCR 2006-> |
| 486139 | DERBI SENDA ->2006 EURO2                                 |



**TEKNIX**  
Original Quality Controller

## EMBIELLAGE

|        |   |
|--------|---|
| 451390 | AM6 montage avec roulement 6303 et 6204 non inclus              |
| 467918 | DERBI GPR   SENDA   RS50   RS4   RX50   SMT   RCR EURO 3 2006-> |
| 451391 | DERBI SENDA EURO 2 ->2006                                       |



**TOP**  
- performances -

## EMBIELLAGE

|        |   |
|--------|---|
| 468138 | AM6 type origine  |
| 462417 | DERBI SENDA EURO 2 ->2006                                       |
| 481319 | DERBI GPR   SENDA   RS50   RS4   RX50   SMT   RCR EURO 3 2006-> |
| 495482 | DERBI SENDA EURO 2 ->2006 avec roulements et joint SPI          |
| 495483 | AM6 avec roulements et joint SPI                                |





## EMBIELLAGE ENDURANCE

|        |                                   |
|--------|-----------------------------------|
| 441283 | 103 SP   MVL ELECTRONIQUE   VOGUE |
| 441285 | 103 SPX   RCX                     |
| 441286 | 51 MBK                            |



## EMBIELLAGE ERI

|               |                                      |
|---------------|--------------------------------------|
| 263966        | 103 SP   MVL ELECTRONIQUE            |
| 263951        | 103 SP   MVL RUPTEUR                 |
| 263977        | 103 SPX   RCX                        |
| 263985        | MBK 51                               |
| 440943        | WALLAROO   FOX   FXR GRAISSAGE SEPRE |
| <b>Bielle</b> |                                      |
| 468868        | MBK 51                               |



## EMBIELLAGE

|        |  |
|--------|--|
| 173517 | 103 SP   MVL électronique avec variateur |
| 169052 | 103 SPX   RCX made in CE                 |
| 4118   | MBK 51 sans clavettage                   |
| 440111 | FOX   FXR avec pompe à huile             |



## TABLEAU DE CÔTÉ DES ROULEMENTS

| N° de côte  | d  | D  | e  |
|-------------|----|----|----|
| 6202        | 15 | 35 | 11 |
| 6203        | 17 | 40 | 12 |
| 6204        | 20 | 47 | 14 |
| 6302        | 15 | 42 | 13 |
| 6303        | 17 | 47 | 14 |
| BB1B447205A | 20 | 52 | 12 |

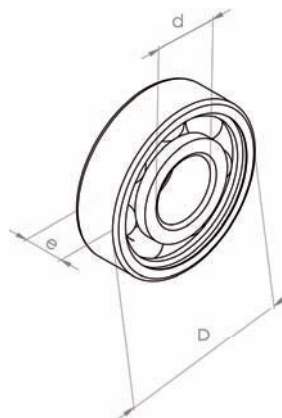

**DOPPLER**

## ROULEMENT VILO ET JOINT SPI EMBIELLAGE

|        | Dimensions   | Type         |              |
|--------|--|--------------|--------------|
| 478935 | BOOSTER   BW'S   NITRO   AEROX   CPI   SR50   OVETTO   STUNT   F12 | C4 polyamide |              |
| 478938 | LUDIX   KISBEE   DJANGO   VIVACITY 2008->                          | 20x47x14     | C4 polyamide |
| 478936 | SPEEDFIGHT   TREKKER   TKR   BUXY   FOX   VIVACITY                 | 20x52x12     | C4 polyamide |
| 478937 | TYPHOON   NRG   STALKER   ZIP   SR50   RUNNER   DNA                | 20x52x11     | C4 polyamide |



## ROULEMENT VILO ET JOINT SPI EMBIELLAGE TYPE ORIGINE

|        |   |  |
|--------|---|--|
| 460598 | BOOSTER   NITRO   OVETTO   STUNT   CPI   AEROX   SR50   F12 |  |
| 460599 | TYPHOON   NRG   RUNNER   DNA   ZIP   SR50   STALKER         |  |
| 488122 | KYMCO 2 temps   |  |
| 488121 | VESPA 50 PK-XL  |  |





## ROULEMENT VILO ET JOINT SPI EMBIELLAGE

|        |  |                      |              |  |
|--------|--|----------------------|--------------|--|
| 210239 | BOOSTER   BW'S   NITRO   AEROX   OVETTO   NEOS   STUNT   CPI - S   SLIDER   SR |                      | C4 polyamide |  |
| 440256 | BOOSTER   BW'S   NITRO   AEROX   OVETTO   NEOS   STUNT   SLIDER kit CELERON    |                      | celeron      |  |
| 484446 | BOOSTER   BW'S   NITRO   AEROX   SR50   STUNT   SLIDER CPI                     |                      | C3 acier     |  |
| 484941 | BOOSTER   NITRO   SR50   STUNT   CPI   |                      | C3 acier     |  |
| 489848 | BOOSTER   BW'S   LUDIX   CPI 6204  | 20x47x14             | C4 polyamide |  |
| 461531 | LUDIX   SPEEDFIGHT 3   VIVACITY 2008->   |                      | C4 polyamide |  |
| 479629 | SPEEDFIGHT 2   TREKKER   TKR pompe à air                                       | 52x20x12<br>47x20x14 |              |  |
| 210224 | SPEEDFIGHT   TREKKER   TKR   BUXY   VIVACITY   FOX                             |                      | C3 acier     |  |
| 210210 | TYPHOON   NRG   RUNNER   STALKER   ZIP   FLY 2 temps   DNA   ICE               |                      |              |  |



210239



484446



## ROULEMENT VILO ET JOINT SPI EMBIELLAGE

|        |   |                           |  |
|--------|---|---------------------------|--|
| 451461 | BOOSTER   BW'S                            | joint spi, h.m. et carter |  |
| 451464 | NITRO   AEROX   SR50LC   F12 liquide      | joint spi, h.m. et carter |  |
| 451466 | SPEEDFIGHT liquide                        | joint spi, h.m. et carter |  |
| 451463 | TREKKER   SPEEDFIGHT AIR   BUXY   TKR air | joint spi, h.m. et carter |  |
| 451462 | TYPHOON   STALKER   ICE   ZIP             | joint spi et h.m.         |  |
| 451465 | NRG   RUNNER   SR50 2005->                | joint spi, h.m. et carter |  |

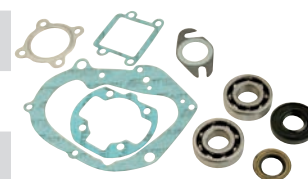

## JOINT SPI EMBIELLAGE TYPE ORIGINE NITRILE

|        |  |    |
|--------|--|----|
| 460597 | BOOSTER   BW'S   NITRO   AEROX   OVETTO   NEOS   SR50   STUNT   SLIDER | x2 |
| 460596 | BOOSTER   BW'S   NITRO   AEROX   SR50                                  | x6 |



460597



460596



## JOINT SPI EMBIELLAGE TYPE ORIGINE (X2)

|        |  |
|--------|--|
| 329853 | BOOSTER   BW'S   NITRO   AEROX   OVETTO   STUNT   NEOS   SLIDER   ROCKET   NEXT   NG |
| 329868 | SPEEDFIGHT   TREKKER   TKR   BUXY   VIVACITY   |
| 467233 | LUDIX   VIVACITY 3   SPEEDFIGHT 3   JET FORCE  |
| 329891 | TYPHOON   NRG   STALKER   ZIP   DNA   ICE VITON                                      |
| 483722 | SCOOTER CHINOIS 139QMB 25x44x7   |



## JOINT SPI EMBIELLAGE TYPE ORIGINE (VITON) (X2)

|        |  |
|--------|--|
| 479579 | BOOSTER   BW'S   NITRO   AEROX   OVETTO   NEOS   MACH G   STUNT   SLIDER |
| 479577 | LUDIX   JET FORCE   VIVACITY 3   SPEEDFIGHT 3                            |
| 479576 | SPEEDFIGHT 2BUXY   TREKKER   TKR   VIVACITY                              |
| 479578 | TYPHOON   STALKER   ZIP   FLY   NRG   ICE   DNA 2 temps                  |



## JOINT SPI EMBIELLAGE (EN TEFLON)

|        |   |
|--------|---|
| 495858 | BOOSTER   BW'S   STUNT   NITRO   AEROX   OVETTO |
| 495857 | TYPHOON   NRG   STALKER   ZIP   DNA   ICE       |



## ROULEMENT VILO ET JOINT SPI EMBIELLAGE

|        |                                     |                      |              |  |
|--------|-------------------------------------|----------------------|--------------|--|
| 478939 | AM6 montage origine 6303 (x2)       | 17x47x14             | C3 polyamide |  |
| 488031 | AM6 DOPPLER origin et ER1 6303+6204 | 17x47x14<br>20x47x14 | C4 polyamide |  |
| 488824 | AM6 DOPPLER endurance 6204 (x2) ER6 |                      | C4 polyamide |  |
| 478942 | DERBI SENDA   GPR tous modèles 6204 | 20x47x14             | C4 polyamide |  |





**ROULEMENT VILO ET JOINT SPI EMBIELLAGE**

|        |                             |                           |          |     |
|--------|-----------------------------|---------------------------|----------|-----|
| 451468 | AM6 2000-> (6303)           | joint SPI et h.m.         | 17x47x14 | NTN |
| 451467 | AM6->1999 (6303)            | joint SPI et h.m.         | 17x47x14 | NTN |
| 451469 | DERBI SENDA GPR EURO 2 6204 | joint SPI, h.m. et carter | 20x47x14 | SKF |



**ROULEMENT VILO ET JOINT SPI TYPE ORIGINE**

|        |                     |     |
|--------|---------------------|-----|
| 460631 | AM6 (6303 17x47x14) | SKF |
| 479422 | DERBI SENDA   GPR   | SKF |



**ROULEMENT VILO ET JOINT SPI EMBIELLAGE**

|        |                        |          |          |     |
|--------|------------------------|----------|----------|-----|
| 265969 | AM6 6303               | 17x47x14 | C4 acier | SKF |
| 479448 | AM6 6303               | 17x47x14 | C3 acier | NTN |
| 329064 | DERBI SENDA   GPR 6204 | 20x47x14 | C4 acier | SKF |
| 479449 | DERBI SENDA   GPR 6204 | 20x47x14 | C3 acier | NTN |



**JOINT SPI EMBIELLAGE TYPE ORIGINE**

|        |     |
|--------|-----|
| 468136 | AM6 |
|--------|-----|



**JOINT SPI EMBIELLAGE (TEFLON)**

|        |                   |
|--------|-------------------|
| 479859 | AM6               |
| 479860 | DERBI SENDA   GPR |





## JOINT SPI EMBIELLAGE (PAIRE)

|        |   |
|--------|---|
| 329917 | AM6 VITON                               |
| 329079 | DERBI SENDA   GPR   FENIX double lèvres |
| 479575 | DERBI   SENDA   GPR   FENIX             |



## ROULEMENT VILO

|        |                              |                   |
|--------|------------------------------|-------------------|
| 496273 | MBK 51 (6302QR TVH renforcé) | C3 cage polyamide |
| 492707 | MBK 51 (6302QR renforcé)     | cage acier        |



## ROULEMENT VILO ET JOINT SPI

|        |                                |                   |               |  |
|--------|--------------------------------|-------------------|---------------|--|
| 323798 | 103 (6203 et 6204)             | 17x47x14 20x47x14 | polyamide     |  |
| 188888 | 103 (6203 et 6204)             | 17x47x14 20x47x14 | C3 acier      |  |
| 323821 | MBK 51 - SKF CAGE ACIER (6302) | 15x42x13          | acier         |  |
| 210224 | FOX   FXR                      | 20x52x12          | C3 acier      |  |
| 492708 | MBK 51(6302)                   | 15x42x13          | C3 cage acier |  |



## ROULEMENT VILO ET JOINT SPI EMBIELLAGE

|        |           |          |              |  |
|--------|-----------|----------|--------------|--|
| 478936 | FOX   FXR | 20x52x12 | C4 polyamide |  |
|--------|-----------|----------|--------------|--|



## JOINT SPI EMBIELLAGE

|        |  |    |
|--------|--|----|
| 329868 | FOX   FXR                                      | x2 |
| 3960   | 103 droit                                      | x1 |
| 3938   | 103 gauche                                     | x1 |
| 4143   | MBK 51   88   41   CADI   89   DAKOTA   PHENIX | x1 |
| 3268   | CIAO PX  | x1 |





**JOINT SPI EMBIELLAGE TEFLON (X2)**

**495860** PEUGEOT 103

**495859** MBK 51 | 88 | 41 | CADI | 89 | DAKOTA | PHENIX



**ROULEMENT VILO**

**Scooter**

|               |  |         |      |          |                   |            |
|---------------|--|---------|------|----------|-------------------|------------|
| <b>7962</b>   | BOOSTER/LUDIX/CPI                          | CELERON | 6204 | 20x47x14 |                   |            |
| <b>7961</b>   | BOOSTER/LUDIX/CPI                          |         | 6204 | 20x47x14 | C4 cage polyamide | <b>SKF</b> |
| <b>7960</b>   | BOOSTER/LUDIX/CPI                          |         | 6204 | 20x47x14 | cage acier        |            |
| <b>7960</b>   | BOOSTER/LUDIX/CPI                          |         | 6204 | 20x47x14 | cage acier        |            |
| <b>191584</b> | SPEEDFIGHT/NRG/TREKKER/<br>TYPHOON/STALKER |         |      | 20x52x12 |                   | <b>NTN</b> |
| <b>489848</b> | BOOSTER/LUDIX/CPI                          |         | 6204 | 20x47x14 | C4 cage polyamide | <b>FAG</b> |

**Moto**

|               |       |         |      |          |                   |            |
|---------------|-------|---------|------|----------|-------------------|------------|
| <b>7962</b>   | SENDA | CELERON | 6204 | 20x47x14 |                   |            |
| <b>7960</b>   | SENDA |         | 6204 | 20x47x14 | cage acier        |            |
| <b>7960</b>   | SENDA |         | 6204 | 20x47x14 | cage acier        |            |
| <b>489849</b> | AM6   |         | 6303 | 17x47x14 | C4 cage polyamide | <b>FAG</b> |
| <b>441253</b> | AM6   |         | 6303 | 17x47x14 | cage acier        |            |
| <b>297064</b> | AM6   | CELERON | 6303 | 17x47x14 |                   |            |

**Cyclo**

|               |            |         |      |          |                   |            |
|---------------|------------|---------|------|----------|-------------------|------------|
| <b>7962</b>   | 103 gauche | CELERON | 6204 | 20x47x14 |                   |            |
| <b>7961</b>   | 103 gauche |         | 6204 | 20x47x14 | C4 cage polyamide | <b>SKF</b> |
| <b>7960</b>   | 103 gauche |         | 6204 | 20x47x14 | cage acier        |            |
| <b>7960</b>   | 103 gauche |         | 6204 | 20x47x14 | cage acier        |            |
| <b>489848</b> | 103 gauche |         | 6204 | 20x47x14 | C4 cage polyamide | <b>FAG</b> |
| <b>7957</b>   | 103 droit  | CELERON | 6203 | 17x40x12 |                   |            |
| <b>7956</b>   | 103 droit  |         | 6203 | 17x40x12 | C3 cage polyamide |            |
| <b>7955</b>   | 103 droit  |         | 6203 | 17x40x12 | cage acier        |            |
| <b>7964</b>   | MBK 51     |         | 6302 | 15x42x13 | C3 cage acier     | <b>SKF</b> |
| <b>3275</b>   | CIAO PX    |         | 6202 | 15x35x11 |                   |            |



# CYLINDRE / CYLINDER



**BOOSTER | BW'S | STUNT | SLIDER | NG | NEXT | ROCKET**



**MOTEUR**

| ALU    |               |           |                                     |                   |          |                    |                    |  |
|--------|---------------|-----------|-------------------------------------|-------------------|----------|--------------------|--------------------|--|
| Marque | Hauts moteurs | Cylindres | Joints hauts moteurs                | Joint de cylindre | Culasses | Joints de culasses | Pistons            | Segments   |
|        | 477549 S1R    | 214655    | 491314                              | 214951            | 215078   | 155427             | 436386<br>Ø39.95mm | 193223<br>épaisseur 1mm  |
|        | 256896        |           | 2360                                |                   |          |                    |                    | 2325<br>épaisseur 1.5mm<br>461305 MHR<br>épaisseur 1mm           |
|        |               | 441319    | 169909<br>451433 (ARTEIN)<br>479350 | 4136              |          |                    | 440260<br>478400   | 247015<br>épaisseur 1.2mm<br>247007<br>épaisseur 1.5mm<br>478401 |

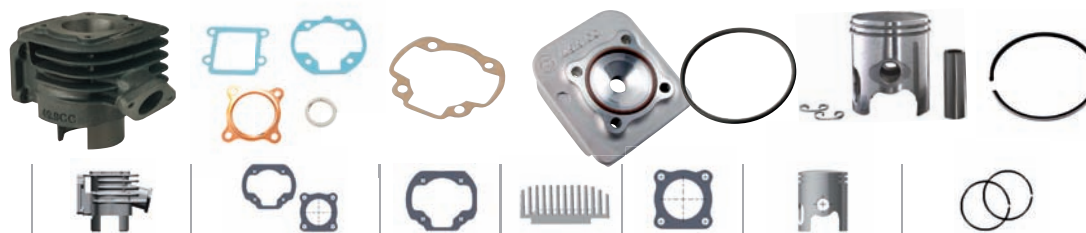

| FONTE |               |                         |                                     |                   |          |                    |                                   |  |
|-------|---------------|-------------------------|-------------------------------------|-------------------|----------|--------------------|-----------------------------------|--|
|       | Hauts moteurs | Cylindres               | Joints hauts moteurs                | Joint de cylindre | Culasses | Joints de culasses | Pistons                           | Segments   |
|       | 477533 S1F    | 376592 S1F              |                                     | 214951            | 215078   | 195427             | 390948<br>Ø39.94mm                | 192807<br>épaisseur 1.2mm                              |
|       | 494639        | 482925 origin           | 491314                              |                   | 215078   |                    | 491315                            | 491316   |
|       | 460959        |                         | 192815                              |                   | 494640   |                    | 190243                            | 191709 bas<br>491026 haut                              |
|       |               | 479126                  |                                     |                   |          |                    | 479537                            |  |
|       | 198411        |                         | 2360                                |                   |          |                    | 212959                            | 2325<br>épaisseur 1.5mm<br>461305 MHR<br>épaisseur 1mm |
|       | 484494        | 484497                  | 467252<br>460487<br>460488          |                   | 460482   |                    | 487580                            | 460485 Ø40mm<br>460486 Ø40.5mm<br>460615               |
|       |               | 488073                  | 467252<br>460487<br>460488          |                   | 460482   |                    |                                   | 460485 Ø40mm<br>496325 Ø40mm<br>460486 Ø40.5mm         |
|       |               | 440569<br>calotte plate | 169909<br>479350<br>451433 (ARTEIN) | 4136              | 378490   | 4135               | 197616<br>calotte bombe<br>478400 | 247015<br>épaisseur 1.2mm<br>247007<br>épaisseur 1.5mm |
|       |               | 482032 (x6)             | 169909<br>479350<br>451433 (ARTEIN) | 4136              | 378490   | 4135               | 486938<br>calotte bombe           | 493271   |

**CYLINDRE / CYLINDER**



**NITRO | AEROX | SR50 LIQUIDE | F12 | MACH 6 LIQUIDE**



**ALU**

| Marque | Hauts moteurs | Cylindres | Jointts hauts moteurs | Joint de cylindre | Culasses | Jointts de culasses | Pistons            | Segments   |
|--------|---------------|-----------|-----------------------|-------------------|----------|---------------------|--------------------|--|
|        | 477538 S1R    | 324555    | 441810 S1R            | 214985            | 324670   | 441810              | 436386<br>Ø39.95mm | 193223<br>épaisseur 1mm                                |
|        | 287579 MHR    |           | 318190                |                   |          |                     | 287598<br>MHR      | 2325<br>épaisseur 1.5mm<br>461305 MHR<br>épaisseur 1mm |

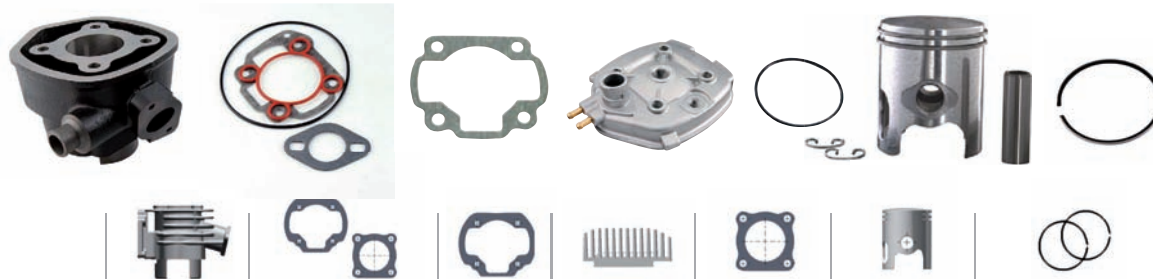

**FONTE**

| Marque | Hauts moteurs | Cylindres  | Jointts hauts moteurs                        | Joint de cylindre | Culasses   | Jointts de culasses                  | Pistons                              | Segments   |
|--------|---------------|------------|--|-------------------|------------|--------------------------------------|--------------------------------------|--|
|        | 477534 S1F    | 460420 S1F | 451436                                       | 214985            | 460456 S1F | 187456<br>TEKNIX<br>451436<br>ARTEIN | 390948<br>Ø39.94mm                   | 192807<br>épaisseur 1.2mm                              |
|        | 460960        |            | 214757                                       |                   | 215211     |                                      | 190243                               | 191709 bas<br>491026 haut                              |
|        |               | 479128     | 479547                                       | 214880            |            | 187456                               |                                      |  |
|        | 484495        |            | 460497                                       |                   |            |                                      | 460483<br>Ø40mm<br>460484<br>Ø40.5mm | 460485 Ø40mm<br>460486 Ø40.5mm                         |
|        |               | 488075     | 460497                                       |                   |            |                                      | 460483<br>Ø40mm<br>460484<br>Ø40.5mm | 460485 Ø40mm<br>460486 Ø40.5mm                         |
|        |               | 251526     | 254889<br>451436 (ARTEIN)<br>467346 (ARTEIN) |                   | 451717     | 187456<br>487166<br>intérieur        |                                      | 247015<br>épaisseur 1.2mm<br>247007<br>épaisseur 1.5mm |
|        |               | 483461     |  |                   |            |                                      |                                      |  |

# CYLINDRE / CYLINDER



**OVETTO | NEOS | MACH G 50 | F12 | BIG MAX AIR | CPI | FLIPPER**

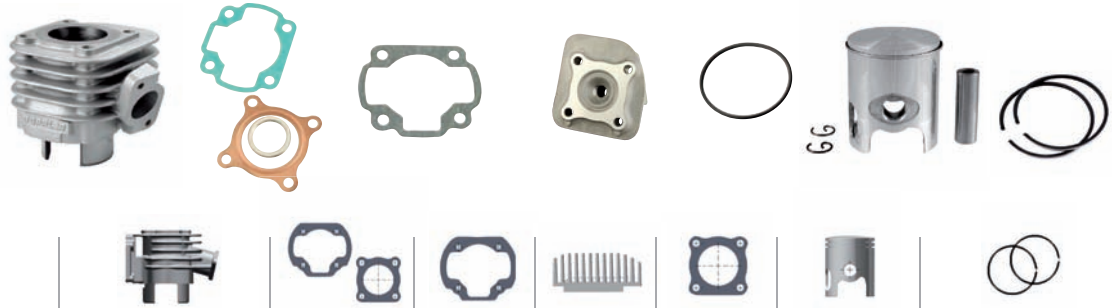

**MOTEUR**

## ALU

| Marque | Hauts moteurs | Cylindres              | Joints hauts moteurs | Joint de cylindre | Culasses      | Joints de culasses | Pistons                   | Segments   |
|--------|---------------|------------------------|----------------------|-------------------|---------------|--------------------|---------------------------|--|
|        | 477542        | <b>214689</b> axe 10mm |                      | <b>214985</b>     | <b>215101</b> | <b>195427</b>      | <b>436386</b><br>Ø39.95mm | <b>193223</b><br>épaisseur 1mm                                       |
|        |               | <b>4108</b> axe 10mm   | <b>369795</b>        | <b>214880</b>     | <b>480430</b> |                    | <b>440260</b>             | <b>247015</b><br>épaisseur 1.2mm<br><b>247007</b><br>épaisseur 1.5mm |



## FONTE

| Marque | Hauts moteurs | Cylindres              | Joints hauts moteurs                       | Joint de cylindre | Culasses      | Joints de culasses | Pistons  | Segments   |
|--------|---------------|------------------------|--|-------------------|---------------|--------------------|--|--|
|        | 460962        |                        | <b>192815</b>                              |                   |               |                    | <b>190243</b>                                      | <b>191709</b> bas<br><b>491026</b> haut                              |
|        | 212944        |                        | <b>2359</b>                                |                   |               |                    | <b>212959</b>                                      | <b>2325</b><br>épaisseur 1.5mm                                       |
|        |               | <b>479127</b> axe 10mm |  |                   |               |                    | <b>479537</b>                                      | <b>479538</b><br>épaisseur 1.6mm                                     |
|        | 484496        | <b>484498</b> axe 10mm | <b>467254</b><br><b>460493</b>             |                   |               |                    | <b>460483</b><br>Ø40mm<br><b>460484</b><br>Ø40.5mm | <b>460485</b> Ø40mm<br><b>460486</b> Ø40.5mm                         |
|        |               | <b>488074</b> axe 10mm | <b>467254</b><br><b>460493</b>             |                   |               |                    | <b>460483</b><br>Ø40mm<br><b>460484</b><br>Ø40.5mm | <b>460485</b> Ø40mm<br><b>460486</b> Ø40.5mm                         |
|        |               | <b>251416</b> axe 10mm | <b>369795</b><br><b>481914</b><br>(ARTEIN) | <b>214880</b>     | <b>480430</b> | <b>4140</b>        |  | <b>247015</b><br>épaisseur 1.2mm<br><b>247007</b><br>épaisseur 1.5mm |
|        |               | <b>482033</b> (x6)     | <b>369795</b><br><b>481914</b><br>(ARTEIN) | <b>214880</b>     | <b>480430</b> | <b>4140</b>        |  | <b>247015</b><br><b>441007</b>                                       |

CYLINDRE / CYLINDER



LUDIX | VIVACITY 3 | SPEEDFIGHT 3 | KISBEE 2 TEMPS AIR



| ALU    |               |           |  |                   |          |                    |  |                           |
|--------|---------------|-----------|--|-------------------|----------|--------------------|--|---------------------------|
| Marque | Hauts moteurs | Cylindres | Joints hauts moteurs                   | Joint de cylindre | Culasses | Joints de culasses | Pistons                                  | Segments                  |
|        | 478486 STR    |           | 479531                                 |                   | 215082   | 195427             | 436300<br>Ø39.94mm<br>268399<br>Ø39.95mm | 193223<br>épaisseur 1mm   |
|        |               | 461886    | 465937<br>465949<br>481913<br>(ARTEIN) | 467229            | 480431   | 467228             | 265165<br>Ø39.90mm                       | 467235<br>épaisseur 1.5mm |

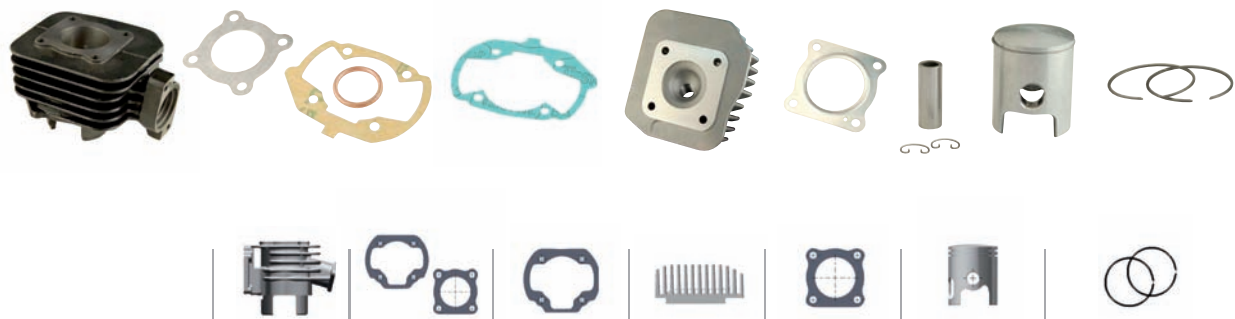

| FONTE  |               |             |                              |                   |          |                    |         |                                |
|--------|---------------|-------------|------------------------------|-------------------|----------|--------------------|---------|--------------------------------|
| Marque | Hauts moteurs | Cylindres   | Joints hauts moteurs         | Joint de cylindre | Culasses | Joints de culasses | Pistons | Segments                       |
|        | 461451        |             |                              |                   |          |                    | 465967  |                                |
|        |               | 480885      |                              |                   |          |                    |         | 479539                         |
|        | 476285        |             | 476290                       |                   |          |                    |         | 460485 Ø40mm<br>460486 Ø40.5mm |
|        |               | 475352      | 465937<br>481913<br>(ARTEIN) |                   | 480431   | 467228             | 265165  | 467235<br>épaisseur 1.5mm      |
|        |               | 482039 (x6) | 465937<br>481913<br>(ARTEIN) | 467229            | 480431   | 467228             | 265165  | 467235                         |

# CYLINDRE / CYLINDER

MOTEUR



## LUDIX | VIVACITY 3 | SPEEDFIGHT 3 | KISBEE 4 TEMPS AIR



### ALU

| Marque | Hauts moteurs | Cylindres        | Joints hauts moteurs | Joint de cylindre | Culasses | Joints de culasses | Pistons | Segments |
|--------|---------------|------------------|----------------------|-------------------|----------|--------------------|---------|----------|
|        |               | 490310<br>495043 |                      |                   |          |                    |         |          |

## LUDIX | BLASTER | JET FORCE LIQUIDE



### ALU

| Marque | Hauts moteurs | Cylindres | Joints hauts moteurs | Joint de cylindre | Culasses | Joints de culasses | Pistons            | Segments                |
|--------|---------------|-----------|----------------------|-------------------|----------|--------------------|--------------------|-------------------------|
|        | 478459        | 478457    | 479531               |                   | 478458   |                    | 436300<br>Ø39.94mm | 193223<br>épaisseur 1mm |



### FONTE

| Marque | Hauts moteurs | Cylindres                  | Joints hauts moteurs   | Joint de cylindre | Culasses | Joints de culasses | Pistons  | Segments |
|--------|---------------|----------------------------|--|-------------------|----------|--------------------|--|----------|
|        |               | 477501<br>472592<br>268786 | 465938<br>460009<br>482059<br>(ARTEIN)<br>451438<br>(ARTEIN) | 467229            |          |                    | 482578 A<br>Ø39.95<br>482579 B<br>Ø39.96<br>265165<br>Ø39.96 |          |

**CYLINDRE / CYLINDER**



**SPEEDFIGHT | BUXY | TREKKER | VIVACITY AIR**

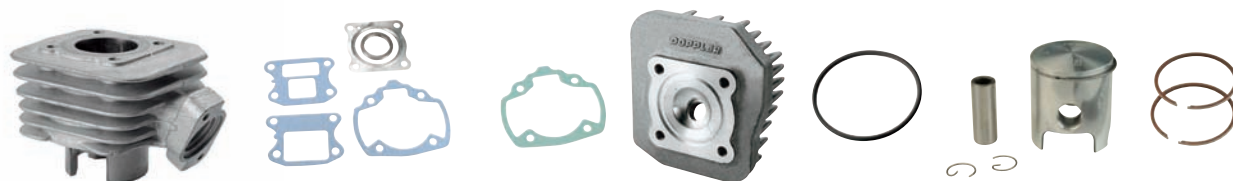

**ALU**

| Marque | Hauts moteurs | Cylindres | Joints hauts moteurs                                   | Joint de cylindre | Culasses | Joints de culasses | Pistons   | Segments                            |
|--------|---------------|-----------|--|-------------------|----------|--------------------|---|-------------------------------------|
|        | 477540        | 214660    |  |                   | 215082   | 195427             | 436300 Ø39.94mm<br>268399 Ø39.95mm                  | 193223<br>épaisseur 1mm             |
|        |               | 176558    | 176725<br>478436<br>451435 (ARTEIN)<br>482059 (ARTEIN) | 172165            | 480431   | 467228             | 482578 A Ø39.95<br>482579 B Ø39.96<br>265165 Ø39.96 | 254711<br>467235<br>épaisseur 1.5mm |

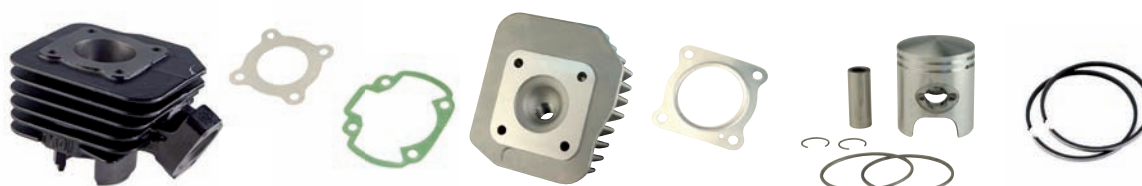

**FONTE**

| Marque | Hauts moteurs | Cylindres      | Joints hauts moteurs                         | Joint de cylindre | Culasses | Joints de culasses | Pistons   | Segments   |
|--------|---------------|----------------|--|-------------------|----------|--------------------|---|--|
|        |               | 479129         |  |                   |          |                    | 479539  |  |
|        | 210258        |                | 214693                                       |                   |          |                    | 461302  | 2325<br>épaisseur 1.5mm<br>461305 MHR<br>épaisseur 1mm |
|        | 467529        | 467528         | 484334                                       |                   |          |                    | 460512 Ø40.00                                       | 460485 Ø40mm<br>460486 Ø40.5mm                         |
|        |               | 488076         | 484334                                       |                   |          |                    | 460512 Ø40.00<br>496321 Ø40.00                      | 460485 Ø40mm<br>460486 Ø40.5mm                         |
|        |               | 220183         | 176725<br>451435 (ARTEIN)<br>482059 (ARTEIN) |                   | 480431   | 467228             | 482578 A Ø39.95<br>482579 B Ø39.96<br>265165 Ø39.96 | 247020<br>ergot déporté<br>254711                      |
|        |               | 482035<br>(x6) | 176725<br>451435 (ARTEIN)<br>482059 (ARTEIN) |                   | 480431   | 467228             | 482578 A Ø39.95<br>482579 B Ø39.96<br>265165 Ø39.96 | 493272   |



## SPEEDFIGHT LIQUIDE

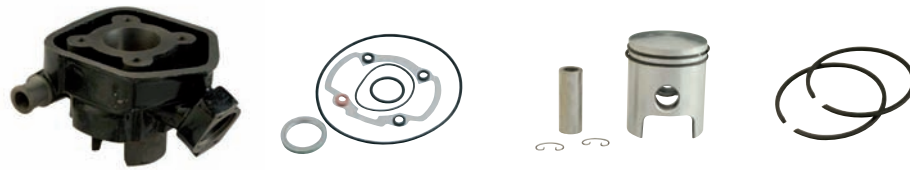

| FONTE  |               |           |                           |                   |          |                    |   |                         |
|--------|---------------|-----------|---------------------------|-------------------|----------|--------------------|---|-------------------------|
| Marque | Hauts moteurs | Cylindres | Joints hauts moteurs      | Joint de cylindre | Culasses | Joints de culasses | Pistons   | Segments                |
|        | 460961        |           | 368382                    |                   |          |                    | 465966  |                         |
|        |               | 479545    | 479548                    |                   |          |                    | 479539  | 479540<br>ergot déporté |
|        | 468139        |           |                           |                   |          |                    | 480876  |                         |
|        |               | 268786    | 460009<br>451438 (ARTEIN) |                   |          |                    | 482578 A Ø39.95<br>482579 B Ø39.96<br>265165 Ø39.96 |                         |

## TYPHOON | ZIP | STALKER | FLY 50 | ICE AIR 2 TEMPS

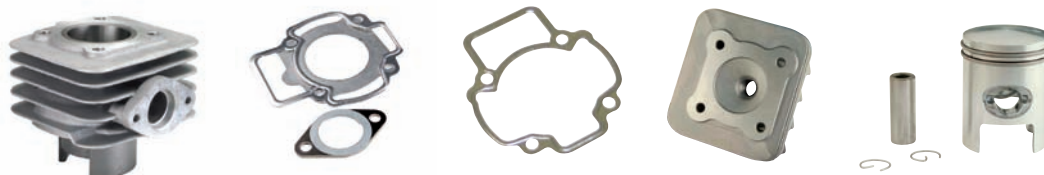

| ALU    |               |           |                      |                   |          |                    |                 |          |
|--------|---------------|-----------|----------------------|-------------------|----------|--------------------|-----------------|----------|
| Marque | Hauts moteurs | Cylindres | Joints hauts moteurs | Joint de cylindre | Culasses | Joints de culasses | Pistons         | Segments |
|        |               | 3240      | 451434<br>(ARTEIN)   | 192982            | 480432   |                    | 246994 Ø39.94mm |          |

CYLINDRE / CYLINDER



TYPHOON | ZIP | STALKER | FLY 50 | ICE AIR 2 TEMPS

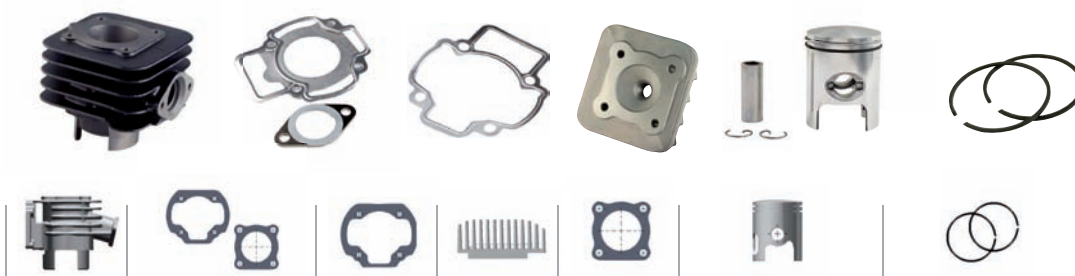

| FONTE  |               |             |                      |                   |          |                    |                              |                                |
|--------|---------------|-------------|----------------------|-------------------|----------|--------------------|------------------------------|--------------------------------|
| Marque | Hauts moteurs | Cylindres   | Joints hauts moteurs | Joint de cylindre | Culasses | Joints de culasses | Pistons                      | Segments                       |
|        |               | 479125      |                      |                   |          |                    | 479535                       | 479536                         |
|        | 467247        | 460498      | 460500               | 460501            |          |                    | 460499 Ø40mm                 | 460485 Ø40mm<br>460486 Ø40.5mm |
|        |               | 488078      |                      |                   |          |                    | 460499 Ø40mm<br>496320 Ø40mm | 460485 Ø40mm<br>460486 Ø40.5mm |
|        |               | 243411      | 451434 (ARTEIN)      | 192982            | 480432   |                    | 246994 Ø39.94mm              | 247020<br>ergot déporté        |
|        |               | 482034 (x6) | 451434 (ARTEIN)      |                   |          |                    | 246994 Ø39.94mm              | 247020<br>ergot déporté        |

NRG | RUNNER

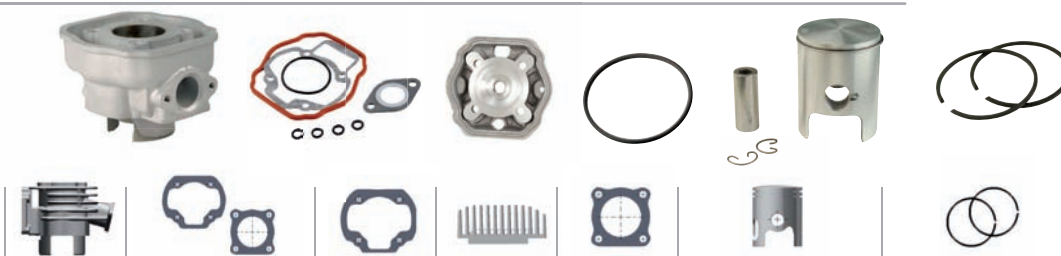

| ALU    |               |           |                      |                   |          |                    |                 |                         |
|--------|---------------|-----------|----------------------|-------------------|----------|--------------------|-----------------|-------------------------|
| Marque | Hauts moteurs | Cylindres | Joints hauts moteurs | Joint de cylindre | Culasses | Joints de culasses | Pistons         | Segments                |
|        | 477539        | 324574    | 450033               |                   | 324699   | 195427             | 440946 Ø39.94mm | 193223<br>épaisseur 1mm |

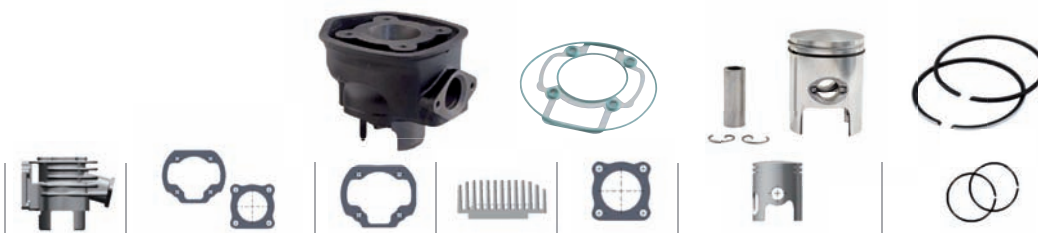

| FONTE  |               |                  |   |                   |          |                    |                 |                                |
|--------|---------------|------------------|---|-------------------|----------|--------------------|-----------------|--------------------------------|
| Marque | Hauts moteurs | Cylindres        | Joints hauts moteurs  | Joint de cylindre | Culasses | Joints de culasses | Pistons         | Segments                       |
|        | 460502        |                  | 460504  |                   |          |                    | 460499 Ø40mm    | 460485 Ø40mm<br>460486 Ø40.5mm |
|        |               | 251507<br>2002-> | 254874 2002-><br>475159<br>toutes années<br>451437<br>toutes années<br>(ARTEIN) |                   |          |                    | 246994 Ø39.94mm | 247020<br>ergot déporté        |



# CYLINDRE / CYLINDER

MOTEUR



KEEWAY | CPI

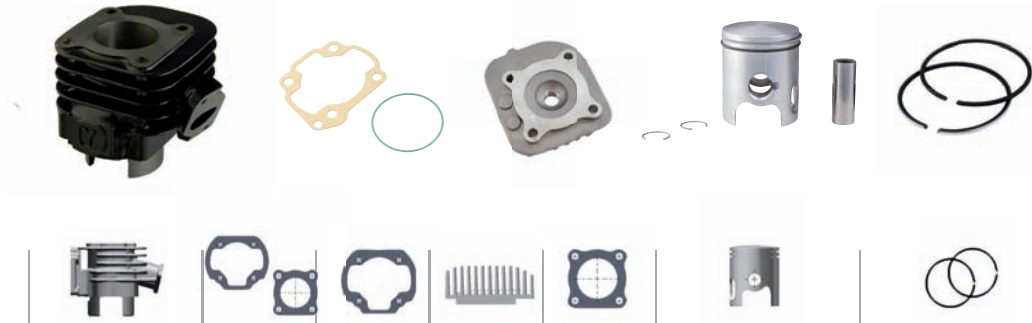

| FONTE  |  |   |                           |                   |               |                    |                                    |  |
|--------|--|---|---------------------------|-------------------|---------------|--------------------|------------------------------------|--|
| Marque | Hauts moteurs                              | Cylindres   | Joints hauts moteurs      | Joint de cylindre | Culasses      | Joints de culasses | Pistons                            | Segments                                     |
|        |  | <b>479544</b><br>axe 12mm<br>Ø40mm EURO 2<br>->2006 |                           |                   |               |                    |                                    |  |
|        | <b>476286</b><br>axe 12mm<br>EURO 2 ->2006 |   | <b>476289</b>             |                   |               |                    | <b>476292</b> axe 12mm             | <b>460485</b> Ø40mm<br><b>460486</b> Ø40.5mm |
|        |  | <b>488077</b><br>axe 12mm<br>Ø40mm EURO 2<br>->2006 | <b>476289</b>             |                   |               |                    | <b>476292</b> axe 12mm             | <b>460485</b> Ø40mm<br><b>460486</b> Ø40.5mm |
|        |  | <b>462482</b><br>axe 12mm<br>EURO 2 ->2006          | <b>482053</b><br>(ARTEIN) |                   | <b>485862</b> |                    | <b>475163</b> axe 12mm<br>Ø39.94mm |  |
|        |  | <b>482040</b> (x6)<br>axe 12mm<br>EURO 2 ->2006     |                           |                   |               |                    |                                    |  |

# SUZUKI | KATANA | MORINI | SR2000 | TGB | ADRESS | SKEGGIA | BENNELLI LIQUIDE

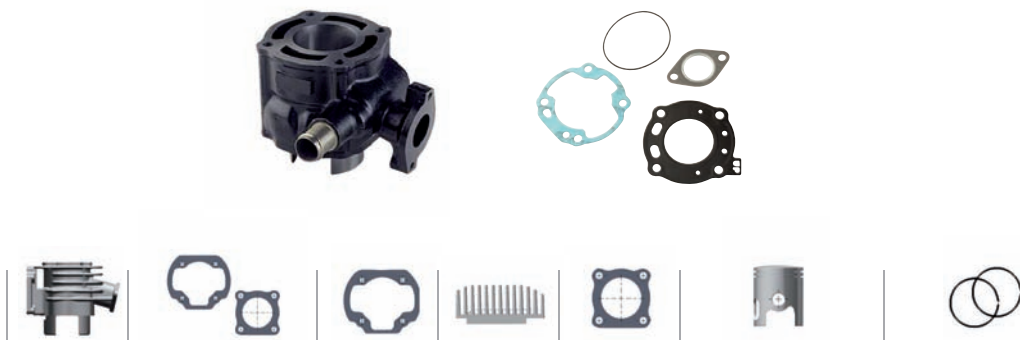

| FONTE  |               |               |                           |                   |          |                    |         |          |
|--------|---------------|---------------|---------------------------|-------------------|----------|--------------------|---------|----------|
| Marque | Hauts moteurs | Cylindres     | Joints hauts moteurs      | Joint de cylindre | Culasses | Joints de culasses | Pistons | Segments |
|        |               | <b>478896</b> | <b>483696</b><br>(ARTEIN) |                   |          |                    |         |          |



**CYLINDRE / CYLINDER**

**SUZUKI | KATANA | MORINI | SR2000 | TGB | ADRESS | SKEGGIA |  
BENNELI AIR**

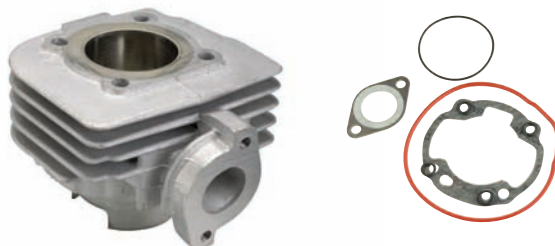

| ALU           |               |           |                      |                   |          |                    |         |          |
|---------------|---------------|-----------|----------------------|-------------------|----------|--------------------|---------|----------|
| Marque        | Hauts moteurs | Cylindres | Joints hauts moteurs | Joint de cylindre | Culasses | Joints de culasses | Pistons | Segments |
| <b>AIRSAL</b> |               | 188998    | 465935               |                   |          |                    |         |          |

**KYMCO MIXER | SNIPER | CALYPSO | RED DEVIL 2 TEMPS**

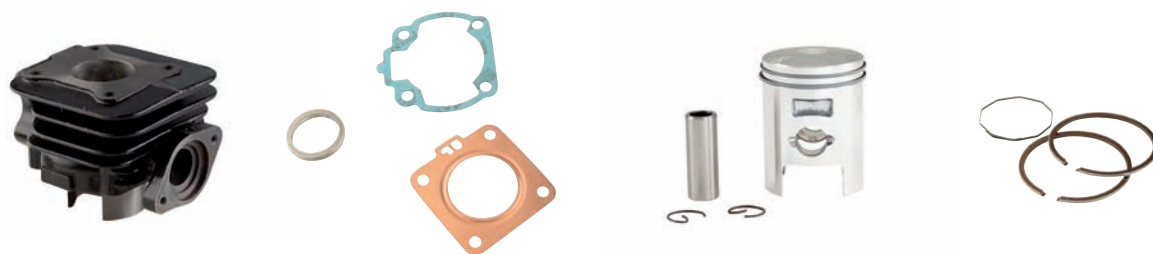

| FONTE         |               |                            |                                    |                   |          |                    |                             |                           |
|---------------|---------------|----------------------------|------------------------------------|-------------------|----------|--------------------|-----------------------------|---------------------------|
| Marque        | Hauts moteurs | Cylindres                  | Joints hauts moteurs               | Joint de cylindre | Culasses | Joints de culasses | Pistons                     | Segments                  |
| <b>TEKNIX</b> |               | 478899<br>485687<br>478895 | 483697 (ARTEIN)<br>476914 (ARTEIN) |                   |          |                    | 479501 axe 12mm<br>Ø38.94mm | 479504<br>épaisseur 1.5mm |



## SYM JET

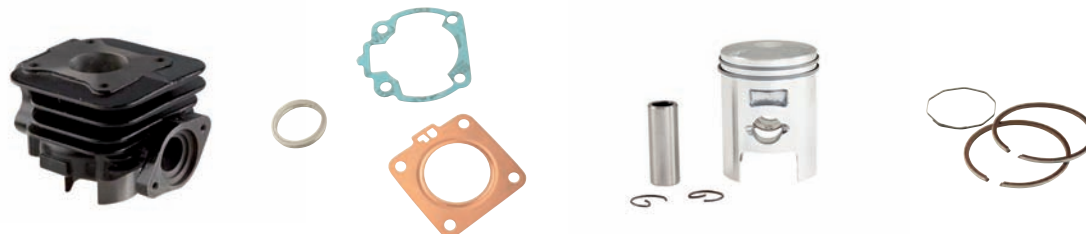

### FORTE

| Marque | Hauts moteurs | Cylindres                  | Joints hauts moteurs               | Joint de cylindre | Culasses | Joints de culasses | Pistons                     | Segments                  |
|--------|---------------|----------------------------|------------------------------------|-------------------|----------|--------------------|-----------------------------|---------------------------|
|        |               | 478899<br>485687<br>478895 | 483697 (ARTEIN)<br>476914 (ARTEIN) |                   |          |                    | 479501 axe 12mm<br>Ø38.94mm | 479504<br>épaisseur 1.5mm |

## SYM MID 4 TEMPS

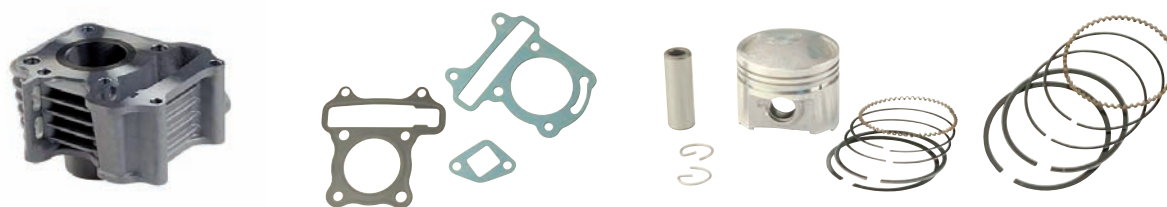

### ALU

| Marque | Hauts moteurs | Cylindres | Joints hauts moteurs | Joint de cylindre | Culasses | Joints de culasses | Pistons      | Segments |
|--------|---------------|-----------|----------------------|-------------------|----------|--------------------|--------------|----------|
|        |               | 478380    | 482346 (ARTEIN)      |                   |          |                    | 479500 Ø37mm | 479503   |



**ZIP | FLY | LIBERTY | VESPA LX 4 TEMPS**



| FONTE  |               |           |                           |                   |          |                    |         |          |
|--------|---------------|-----------|---------------------------|-------------------|----------|--------------------|---------|----------|
| Marque | Hauts moteurs | Cylindres | Joints hauts moteurs      | Joint de cylindre | Culasses | Joints de culasses | Pistons | Segments |
|        |               | 481503    |                           |                   |          |                    |         |          |
|        |               | 482203    | 479349<br>492123 (ARTEIN) |                   |          |                    | 482204  | 482205   |

**SCOOTER CHINOIS 4 TEMPS | V-CLIC | AGILITY 139 QMB**

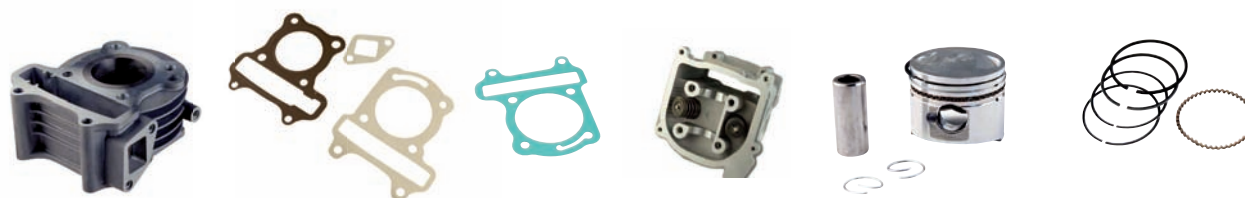

| ALU    |               |              |                           |                   |          |                    |                              |          |
|--------|---------------|--------------|---------------------------|-------------------|----------|--------------------|------------------------------|----------|
| Marque | Hauts moteurs | Cylindres    | Joints hauts moteurs      | Joint de cylindre | Culasses | Joints de culasses | Pistons                      | Segments |
|        |               | 478900       | 468201<br>482346 (ARTEIN) | 467719            | 480095   |                    | 473117 Ø39mm<br>482204 Ø39mm | 475181   |
|        |               | 478900<br>x6 |                           |                   |          |                    |                              | 475181   |

# CYLINDRE / CYLINDER



AM6

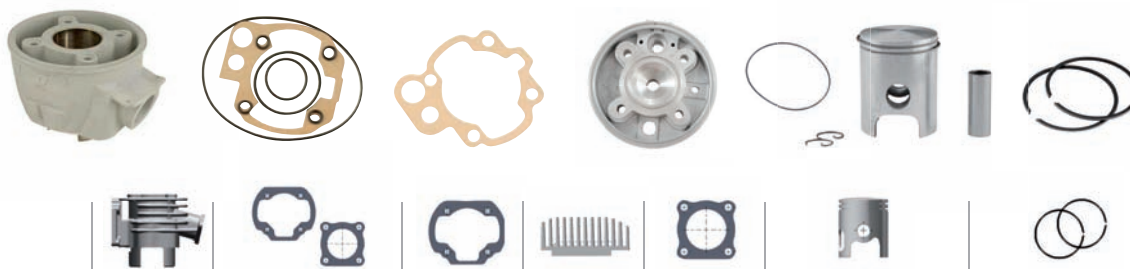

## ALU

| Marque | Hauts moteurs | Cylindres | Joints hauts moteurs  | Joint de cylindre | Culasses | Joints de culasses                | Pistons  | Segments             |
|--------|---------------|-----------|---|-------------------|----------|-----------------------------------|--|----------------------|
|        | 480587        |           | 480615  |                   | 490484   | 493616 extérieur                  | 481154 Ø40.30mm  | 481156               |
|        | 461240        |           | 461326  |                   |          |                                   | 461300   | 461306 épaisseur 1mm |
|        | 220399        |           | 329906 ->2000<br>450555 2001-><br>451440 2000-><br>(ARTEIN) | 467561            |          | 487169 extérieur<br>487170 goujon | 482577 sauf AIRSAL Ø40.30mm<br>459087 sauf AIRSAL Ø40.30mm<br>451399 | 455107 sauf AIRSAL   |

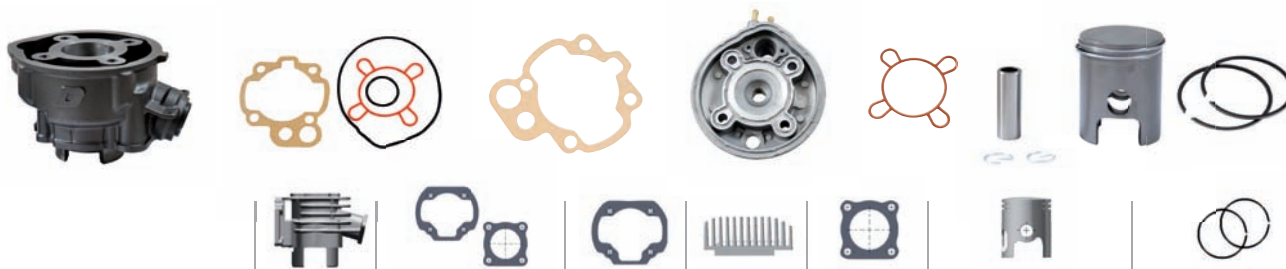

## FONTE

| Marque | Hauts moteurs | Cylindres          | Joints hauts moteurs   | Joint de cylindre | Culasses      | Joints de culasses                | Pistons  | Segments  |
|--------|---------------|--------------------|--|-------------------|---------------|-----------------------------------|--|---|
|        | 491302        | 494088             | 491305   |                   | 494090 2001-> |                                   | 491310   | 491311 Ø40.30mm<br>324388                             |
|        | 486820        |                    | 465952   |                   |               |                                   | 490657 Ø40.30mm  | 460524 Ø40.30mm                                       |
|        | 460519        |                    | 467262<br>460527   |                   | 460520        |                                   | 460521 Ø40.30mm<br>460522 Ø40.60mm<br>460523 Ø40.80mm                    | 460525 Ø40.60mm<br>460526 Ø40.80mm                    |
|        | 488082        |                    | 467262<br>460527   |                   | 460520        |                                   | 460521 Ø40.30mm<br>460522 Ø40.60mm<br>460523 Ø40.80mm<br>496323 Ø40.30mm | 460525 Ø40.60mm<br>460526 Ø40.80mm<br>496326 Ø40.30mm |
|        | 479130        |                    | 479549   | 467561            |               | 482060 2001-> intérieur           | 479541   | 479542 Ø40.30mm                                       |
|        |               | 317341 ->2002      | 329906 ->2001<br>450555 2001-><br>451439 ->2001 (ARTEIN)<br>451440 2001-> (ARTEIN) | 467561            | 482626 2001-> | 487169 extérieur<br>487170 goujon | 482577 sauf AIRSAL Ø40.30mm<br>459087 sauf AIRSAL Ø40.30mm               | 455107 sauf AIRSAL<br>490449<br>493274                |
|        |               | 482036 ->2003 (x6) | 329906 ->2001<br>450555 2001-><br>451439 ->2001 (ARTEIN)<br>451440 2001-> (ARTEIN) | 467561            | 482626 2001-> | 487169 extérieur<br>487170 goujon | 482577 sauf AIRSAL Ø40.30mm<br>459087 sauf AIRSAL Ø40.30mm               | 455107 sauf AIRSAL<br>490449<br>493274                |

## CYLINDRE / CYLINDER



**DERBI EURO 2**

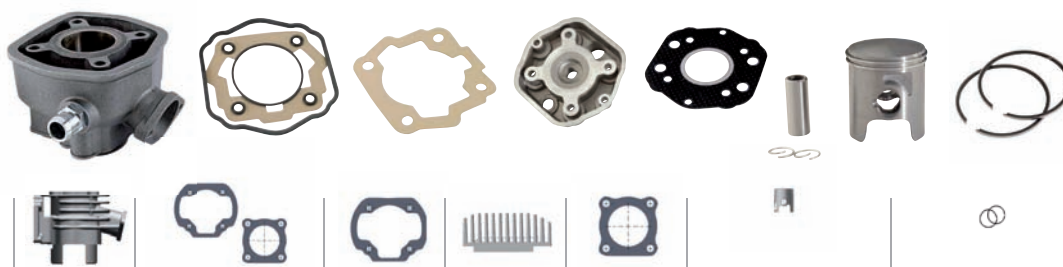

| ALU    |               |  |                      |                   |                  |                    |  |   |
|--------|---------------|--|----------------------|-------------------|------------------|--------------------|--|---|
| Marque | Hauts moteurs | Cylindres  | Joints hauts moteurs | Joint de cylindre | Culasses         | Joints de culasses | Pistons                                  | Segments  |
|        |               |  | 465479               |                   |                  |                    |  |   |
|        | 220384        | 329906<br>455415<br>482345<br>440925 (ARTEIN)<br>467347 (ARTEIN) |                      | 440254            | 482628<br>451721 | 440255             | 482580<br>épaisseur 1.2mm<br>sauf AIRSAL | 482581<br>épaisseur 1.2mm<br>sauf AIRSAL<br>265830 AIRSAL |
|        | 492431        |  | 265844               | 440254            |                  |                    | 265825                                   |   |

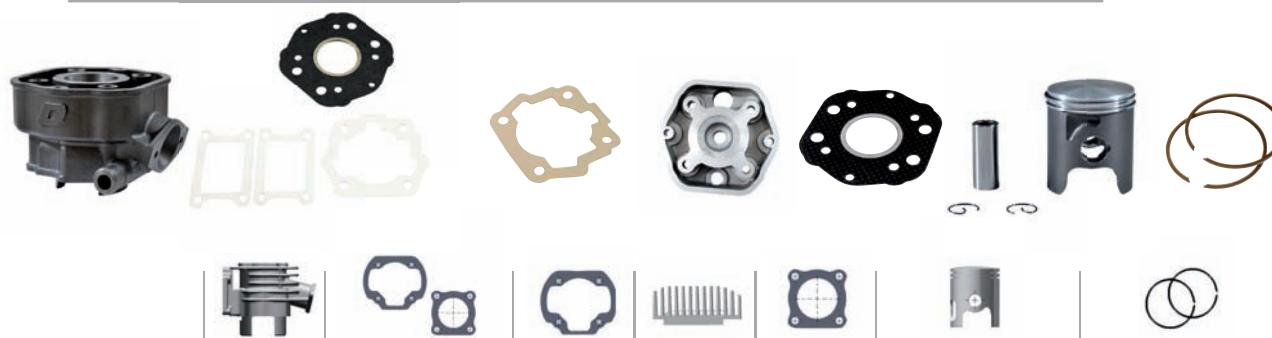

| FONTE  |               |             |  |                   |          |                    |  |  |
|--------|---------------|-------------|--|-------------------|----------|--------------------|--|--|
| Marque | Hauts moteurs | Cylindres   | Joints hauts moteurs                         | Joint de cylindre | Culasses | Joints de culasses | Pistons  | Segments   |
|        | 491303        | 494089      | 491307                                       |                   | 494091   |                    | 491308   | 491313   |
|        | 460514        |             | 460518<br>461199                             |                   | 460515   |                    | 460516<br>Ø39.85mm                                 | 460517<br>Ø40mm<br>467277<br>Ø40.28mm              |
|        | 488083        |             | 460518<br>461199                             |                   |          |                    | 460516<br>Ø39.85mm<br>496324<br>Ø40.00mm           | 496327   |
|        | 479131        |             | 479546                                       |                   |          |                    | 479543   | 482542   |
|        |               | 477649      | 455415<br>440925 (ARTEIN)<br>467347 (ARTEIN) | 440254            | 482628   | 440255             | 482580<br>épaisseur 1.2mm<br>sauf AIRSAL<br>478114 | 482581<br>épaisseur 1.2mm<br>sauf AIRSAL<br>493276 |
|        |               | 482037 (x6) | 455415<br>440925 (ARTEIN)<br>467347 (ARTEIN) | 440254            | 482628   | 440255             | 482580<br>épaisseur 1.2mm<br>sauf AIRSAL<br>478114 | 482581<br>épaisseur 1.2mm<br>sauf AIRSAL<br>493276 |



## DERBI EURO 3



| ALU    |                        |           |  |                              |          |                    |  |  |
|--------|------------------------|-----------|--|------------------------------|----------|--------------------|--|--|
| Marque | Hauts moteurs          | Cylindres | Joints hauts moteurs                   | Joint de cylindre            | Culasses | Joints de culasses | Pistons                                  | Segments                                 |
|        | 480588                 |           | 480614                                 |                              | 488883   |                    | 481155<br>Ø39.84mm                       | 481157                                   |
|        | 481377                 |           |  |                              |          |                    | 494443                                   |  |
|        | 467903<br>MHR          |           | 475333                                 |                              |          |                    | 461301                                   | 487744                                   |
|        | 466945                 | 472591    | 472507<br>475160<br>467344<br>(ARTEIN) | 487167<br>482779<br>(ARTEIN) | 482627   | 487168<br>487171   | 482580<br>épaisseur 1.2mm<br>sauf AIRSAL | 455108<br>épaisseur 1.5mm<br>sauf AIRSAL |
|        | 479510<br>(bi-segment) |           | 482001                                 |                              |          |                    | 265825                                   |  |



| FONTE  |               |                |  |                   |                  |                    |  |  |
|--------|---------------|----------------|--|-------------------|------------------|--------------------|--|--|
| Marque | Hauts moteurs | Cylindres      | Joints hauts moteurs                   | Joint de cylindre | Culasses         | Joints de culasses | Pistons  | Segments   |
|        | 491304        | 496866         | 491306                                 |                   | 496867           |                    | 491309   | 491313   |
|        | 492995        |                | 494442                                 |                   |                  |                    | 494443   |  |
|        | 480875        |                | 482534                                 | 482779            | 482627<br>491666 |                    | 481921<br>Ø39.80mm                                 | 481829   |
|        |               | 477192         | 472507<br>475160<br>467344<br>(ARTEIN) | 482779<br>487167  | 482627           | 487168<br>487171   | 482580<br>épaisseur 1.2mm<br>sauf AIRSAL<br>478114 | 482581<br>épaisseur 1.2mm<br>sauf AIRSAL<br>493276 |
|        |               | 482038<br>(x6) | 472507<br>475160<br>467344<br>(ARTEIN) | 482779<br>487167  |                  | 487168<br>487171   | 482580<br>épaisseur 1.2mm<br>sauf AIRSAL<br>478114 | 482581<br>épaisseur 1.2mm<br>sauf AIRSAL<br>493276 |



CPI SUPER MOTARD

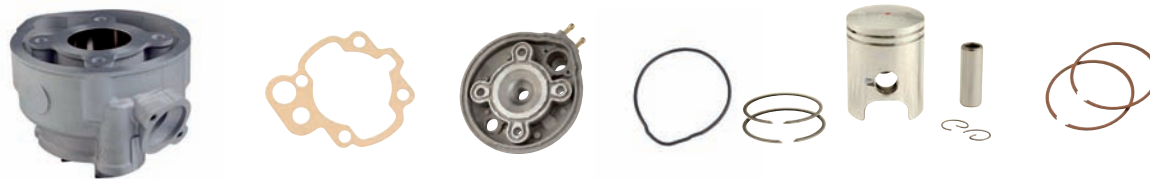

ALU

| Marque | Hauts moteurs | Cylindres | Joints hauts moteurs | Joint de cylindre | Culasses         | Joints de culasses         | Pistons                  | Segments |
|--------|---------------|-----------|----------------------|-------------------|------------------|----------------------------|--------------------------|----------|
|        | 478325        |           |                      | 467561            | 482626<br>2001-> | 487169<br>482060<br>491305 | 481626 axe 12mm<br>Ø40mm | 455107   |

SUZUKI | RMX | SMX

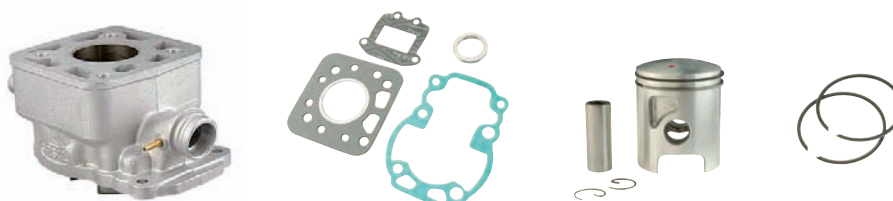

ALU

| Marque | Hauts moteurs | Cylindres | Joints hauts moteurs                | Joint de cylindre | Culasses | Joints de culasses | Pistons         | Segments        |
|--------|---------------|-----------|-------------------------------------|-------------------|----------|--------------------|-----------------|-----------------|
|        |               | 450493    | 475681<br>450502<br>467345 (ARTEIN) |                   |          |                    | 450500 Ø40.94mm | 450501 Ø40.94mm |





## 103 AIR

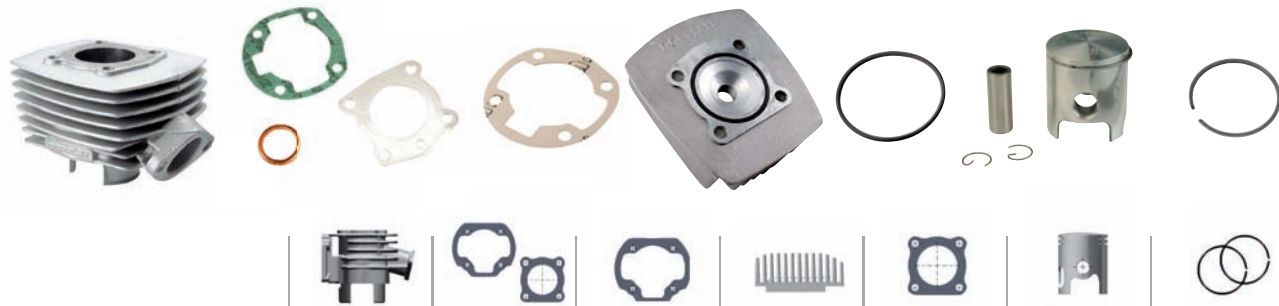

| ALU    |               |           |                      |                   |          |                         |  |          |
|--------|---------------|-----------|----------------------|-------------------|----------|-------------------------|--|----------|
| Marque | Hauts moteurs | Cylindres | Joints hauts moteurs | Joint de cylindre | Culasses | Joints de culasses      | Pistons  | Segments |
|        |               | 197248    |                      | 214990            | 192270   | 195427                  | 436300<br>Ø39.94mm<br>268399   | 193223   |
|        |               | 2153      | 214765               |                   |          |                         |  |          |
|        |               | 665       | 329930               | 683               | 671      | 681<br>2361<br>renforcé | 251139<br>Ø39.88mm<br>192671<br>Ø39.90mm<br>192686<br>192697<br>Ø39.92mm | 678      |
|        |               | 2172      |                      |                   |          |                         | 2292   | 174741   |

## 103 LIQUIDE

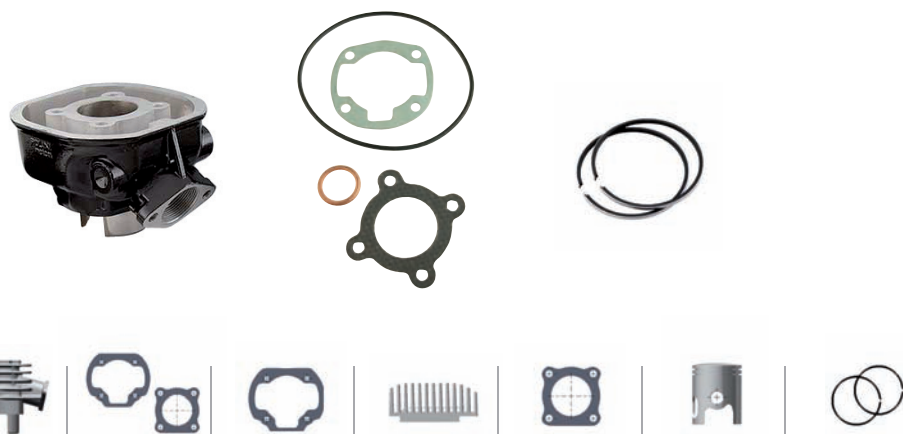

| ALU    |               |           |                      |                   |          |                    |         |          |
|--------|---------------|-----------|----------------------|-------------------|----------|--------------------|---------|----------|
| Marque | Hauts moteurs | Cylindres | Joints hauts moteurs | Joint de cylindre | Culasses | Joints de culasses | Pistons | Segments |
|        |               |           | 2247                 |                   |          |                    | 2295    | 2325     |

CYLINDRE / CYLINDER



103 FOX | FXR

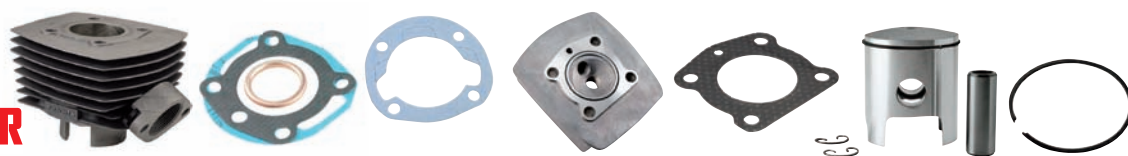

ALU

| Marque | Hauts moteurs | Cylindres | Joints hauts moteurs | Joint de cylindre | Culasses | Joints de culasses   | Pistons | Segments |
|--------|---------------|-----------|----------------------|-------------------|----------|----------------------|---------|----------|
|        |               | 441318    | 451442 (ARTEIN)      | 683               | 671      | 681<br>2361 renforcé | 2292    | 174741   |

MBK 51 AIR



ALU

| Marque | Hauts moteurs | Cylindres | Joints hauts moteurs | Joint de cylindre | Culasses | Joints de culasses | Pistons                            | Segments |
|--------|---------------|-----------|----------------------|-------------------|----------|--------------------|------------------------------------|----------|
|        |               | 197252    |                      | 215006            | 192246   | 195427             | 441756                             | 193219   |
|        |               | 4107      |                      | 4127              | 4115     | 4125               | 4110<br>192743<br>192762<br>479537 | 4112     |
|        |               | 265696    |                      | 4127              |          | 4125               | 269156<br>479537                   | 330432   |

MBK 51 LIQUIDE



ALU

| Marque | Hauts moteurs | Cylindres | Joints hauts moteurs | Joint de cylindre | Culasses | Joints de culasses | Pistons | Segments |
|--------|---------------|-----------|----------------------|-------------------|----------|--------------------|---------|----------|
|        | 475522        |           | 4123                 | 4127              |          |                    | 192762  | 4112     |
|        |               | 170880    |                      |                   |          |                    | 193075  |          |

# CYLINDRE / CYLINDER

MOTEUR



## AV7 88/99

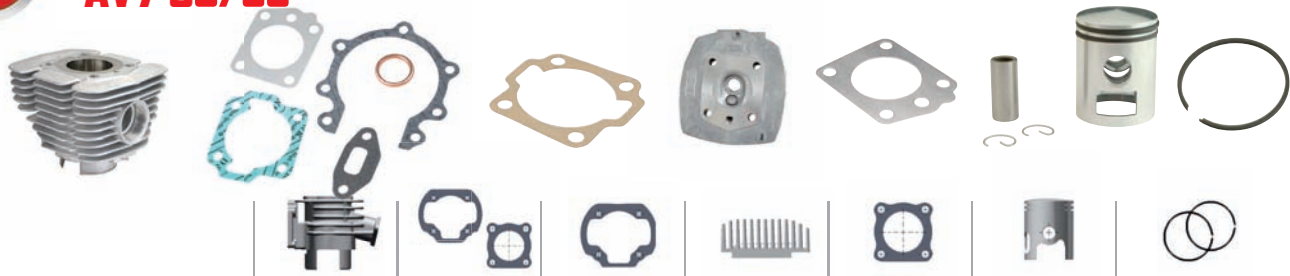

| ALU    |               |           |                      |                   |          |                    |                |          |
|--------|---------------|-----------|----------------------|-------------------|----------|--------------------|----------------|----------|
| Marque | Hauts moteurs | Cylindres | Joints hauts moteurs | Joint de cylindre | Culasses | Joints de culasses | Pistons        | Segments |
|        |               | 4106      | 490338               | 4128              | 480969   | 4125               | 4110<br>192743 | 4112     |
|        |               | 496246    |                      |                   |          |                    |                |          |

## DAKOTA | KANSAS | PHENIX



| ALU    |               |           |                      |                   |          |                    |                |          |
|--------|---------------|-----------|----------------------|-------------------|----------|--------------------|----------------|----------|
| Marque | Hauts moteurs | Cylindres | Joints hauts moteurs | Joint de cylindre | Culasses | Joints de culasses | Pistons        | Segments |
|        |               | 480961    | 479537               | 4127              | 4115     | 4125               | 4110<br>192743 | 4112     |

## CIAO PX



| FONTE  |               |                                    |                      |                   |          |                    |         |                        |
|--------|---------------|------------------------------------|----------------------|-------------------|----------|--------------------|---------|------------------------|
| Marque | Hauts moteurs | Cylindres                          | Joints hauts moteurs | Joint de cylindre | Culasses | Joints de culasses | Pistons | Segments               |
|        |               | 468141<br>Ø10mm<br>468142<br>Ø12mm |                      | 3265              |          |                    | 3244    | 3264<br>3259<br>479505 |



## PISTON SIF CYLINDRE FONTE

|        |   |          |
|--------|---|----------|
| 390948 | BOOSTER   BW'S   NITRO   AEROX   2 segments pour cylindre fonte | Ø39.94mm |
|--------|---|----------|



## PISTON SIR CYLINDRE ALU

|        |   |          |
|--------|---|----------|
| 436386 | BOOSTER   NITRO   SR50   F12   BIG MAX Vertex | Ø39.95mm |
| 440946 | RUNNER   NRG   TYPHOON Malhe                  | Ø39.94mm |
| 436300 | TREKKER   BUXY   103   LUDIX Malhe            | Ø39.94mm |
| 268399 | TREKKER   BUXY   103   LUDIX Malhe            | Ø39.95mm |



## PISTON ORIGINE CYLINDRE FONTE

|        |   |          |
|--------|---|----------|
| 491315 | BOOSTER   BW'S   STUNT   SLIDER   ROCKET   NEXT | Ø39.94mm |
|--------|---|----------|



## PISTON CYLINDRE FONTE

|        |   |          |
|--------|---|----------|
| 479537 | BOOSTER   BW'S   OVETTO   NEOS   NITRO   AEROX   STUNT   SLUDER   SR50 JOG R   MACH G | Ø39.94mm |
| 479539 | TREKKER   SPEEDFIGHT 2   BUXY   LUDIX   |          |
| 479535 | TYPHOON   ZIP   NRG   STALKER   SR50 2005   DNA ice                                   | Ø39.95mm |



## PISTON CYLINDRE FONTE

|        |  |  |
|--------|--|--|
| 190243 | BOOSTER   NITRO   SR50   F12   BIG MAX |  |
|--------|--|--|



## PISTON CYLINDRE FONTE

|        |   |          |
|--------|---|----------|
| 212959 | BOOSTER   NITRO   AEROX   SR50   F12   BIG MAX AIR                  | Ø39.93mm |
| 461302 | TREKKER   SPEEDFIGHT   TYPHOON   NRG   RUNNER                       | Ø39.93mm |
| 287598 | BOOSTER   BW'S   NITRO   OVETTO   SR50LC   F12LC   MHR cylindre alu |          |





# PISTON / PISTON

# MOTEUR

## PISTON

|        |   |          |
|--------|---|----------|
| 487580 | BOOSTER   NITRO   SR50   F12 pour cylindre/haut moteur Black Trophy | Ø40mm    |
| 460483 | BOOSTER   NITRO   SR50   F12  | Ø40mm    |
| 460484 | BOOSTER   NITRO   SR50   F12  | Ø40.5mm  |
| 480876 | SPEEDFIGHT liquide pour cylindre fonte (468139)                     | Ø39.84mm |
| 460512 | SPEEDFIGHT   TREKKER   BUXY   LUDIX                                 | Ø40mm    |
| 460499 | TYPHOON   ZIP   RUNNER   NRG   STALKER   SR50 2005-> ICE   DNA      | Ø40mm    |
| 476292 | KEEWAY   CPI axe 12mm   | Ø40mm    |



## PISTON

|        |  |       |
|--------|--|-------|
| 496319 | BOOSTER   NITRO   SR50   F12                                   | Ø40mm |
| 496320 | TYPHOON   ZIP   RUNNER   NRG   STALKER   SR50 2005-> ICE   DNA | Ø40mm |
| 496321 | SPEEDFIGHT   TREKKER   BUXY   LUDIX                            | Ø40mm |
| 496322 | KEEWAY   CPI axe 12mm  | Ø40mm |



## PISTON POUR CYLINDRE ORIGINE ET ADAPTABLE SAUF AIRSAL MADE IN CE

|        |  |          |
|--------|--|----------|
| 478068 | BOOSTER   BW'S 1999-> calotte plate                            | Ø39.96mm |
| 478069 | SPEEDFIGHT   TREKKER   BUXY                                    | Ø39.93mm |
| 478070 | TYPHOON   ZIP   RUNNER   NRG   STALKER   SR50 2005-> ice   DNA | Ø39.94mm |



## PISTON MADE IN CE

|        |  |          |
|--------|--|----------|
| 486938 | BOOSTER   BW'S   STUNT   SLIDER   calotte bombée | Ø39.93mm |
| 487369 | CPI   KEEWAY calotte bombée axe de 12mm Ø39.97mm |          |



Sélection  
**CGN****PISTON POUR CYLINDRE ORIGINE ET ADAPTABLE SAUF AIRSAL**

|        |   |          |
|--------|---|----------|
| 197616 | BOOSTER calotte bombée  | Ø39.94mm |
| 440260 | BOOSTER calotte plate   | Ø39.94mm |
| 478400 | OVETTO   BOOSTER X   NEOS   BOX X   AEROX   NITRO 4 temps                 | Ø38mm    |
| 254578 | NITRO   F12L   SR50   CPI   AEROX   OVETTO LC   AIR axe 10mm              | Ø39.95mm |
| 482578 | SPEEDFIGHT   TREKKER   BUXY   LUDIX   KISBEE                              | Ø39.95mm |
| 482579 | SPEEDFIGHT   TREKKER   BUXY   LUDIX   KISBEE                              | Ø39.96mm |
| 265165 | SPEEDFIGHT   TREKKER   BUXY   LUDIX   KISBEE                              | Ø39.96mm |
| 246994 | TYPHOON   ZIP   NRG   FLY   STALKER   RUNNER   ET2   LIBERTY 2 temps 50CC | Ø39.95mm |
| 482204 | PIAGGIO ZIP   FLY   LIBERTY   VESPA LX 4 temps 50CC                       | Ø39mm    |
| 475163 | CPI   KEEWAY axe 12mm   | Ø39.99mm |
| 479501 | SYM 2 temps   KYMCO MIXER   SNIPER   CALYPSO axe 12mm                     | Ø39.96mm |
| 479500 | 4 temps SYM 50CC MIO   ORBIT  | Ø37mm    |
| 473117 | 4 temps CHINOIS 50CC   V CLIC   139QMB   AGILITY axe 13mm                 | Ø39mm    |

**AIRSAL**  
The power of engine**PISTON POUR CYLINDRE**

|        |  |          |
|--------|--|----------|
| 169693 | BOOSTER   BW'S   STUNT   SLIDER   SR50   OVETTO   NEOS   NITRO   AEROX | Ø39.95mm |
| 465960 | LUDIX BLASTER  | Ø39.88mm |

**DOPPLER****SEGMENT (X1)**

|        |  |           |
|--------|--|-----------|
| 192807 | BOOSTER   NITRO   SR50   F12   BIG MAX chrome pour cylindre fonte S1F                | Ø40x1.2mm |
| 193223 | BOOSTER   NITRO   103 acier doublé chrome pour cylindre alu S1R                      | Ø40x1mm   |
| 491316 | BOOSTER   BW'S   STUNT   SLIDER   ROCKET   NEXT   pour cylindre fonte DOPPLER origin |           |

**SEGMENT (X2)**

|        |   |           |
|--------|---|-----------|
| 479538 | BOOSTER   OVETTO   NITRO   CPI   KEEWAY                 | Ø40x1.6mm |
| 479540 | SPEEDFIGHT 2 liquide jeu à ergot déporté                | Ø40x1.5mm |
| 479536 | TYPHOON   STALKER   NRG   ICE   DNA   SR50 2005->   ZIP | Ø40x1.5mm |

**polini**  
motor**SEGMENT (X1)**

|        |   |           |
|--------|---|-----------|
| 2335   | AM6   BOOSTER évolution                           | Ø40.2x1mm |
| 491026 | BOOSTER   NITRO   SR50   BIG MAX supérieur chrome | Ø40mm     |
| 191709 | BOOSTER   NITRO   SR50   F12   BIG MAX inférieur  | Ø40x1.2mm |
| 196988 | SPEEDFIGHT   TREKKER   TYPHOON   ZIP              | Ø40x1.5mm |





**MALOSSİ**

### SEGMENT

|               |   |           |
|---------------|---|-----------|
| <b>461305</b> | BOOSTER   NITRO   SR50 LC   F12 LC   NRG (x1)     | Ø40x1mm   |
| <b>2325</b>   | BOOSTER   NITRO   103   SPEEDFIGHT   TYPHOON (x2) | Ø40x1.5mm |
| <b>487898</b> | MHR bi-segments (x2)                              | Ø40x1.5mm |



### SEGMENT POUR PISTON TYPE ORIGINE (X2)

|               |                                 |           |
|---------------|---------------------------------|-----------|
| <b>460615</b> | BOOSTER   NITRO ergots déportés | Ø40x1.2mm |
| <b>460612</b> | BOOSTER   NITRO ergots déportés | Ø40x1.5mm |



**BIDALOT**

### SEGMENT FONTE (X1)

|           |                               |         |
|-----------|-------------------------------|---------|
| <b>95</b> | SCOOTER   103 ergot intérieur | Ø40x1mm |
|-----------|-------------------------------|---------|



### SEGMENT POUR CYLINDRE FONTE (X2)

|               |  |         |
|---------------|--|---------|
| <b>460485</b> | BOOSTER   KEEWAY   LUDIX   TYPHOON ergots intérieurs | Ø40mm   |
| <b>460486</b> | BOOSTER   KEEWAY   LUDIX ergots intérieurs           | Ø40.5mm |



### SEGMENT POUR CYLINDRE ALU (X1)

|               |                              |       |
|---------------|------------------------------|-------|
| <b>467276</b> | BOOSTER   NITRO   SR50   F12 | Ø40mm |
|---------------|------------------------------|-------|





**SEGMENT POUR CYLINDRE FONTE (X2)**

|        |  |       |
|--------|--|-------|
| 496325 | BOOSTER   KEEWAY   LUDIX   TYPHOON ergots intérieurs | Ø40mm |
|--------|--|-------|



**SEGMENT POUR CYLINDRE ORIGINE ET ADAPTABLE (X2)**

|                |  |                 |
|----------------|--|-----------------|
| 247015         | BOOSTER   NITRO   SR50   F12                                   | épaisseur 1.2mm |
| 247007         | BOOSTER   NITRO   SR50   F12                                   | épaisseur 1.5mm |
| 467235         | LUDIX   SPEEDFIGHT 3   VIVACITY 3   KISBEE   DJANGO            | Ø39.93x1.5mm    |
| 254711         | SPEEDFIGHT   TREKKER   BUXY                                    |                 |
| 247020         | TYPHOON   ZIP   FLY   STALKER CYL   FONTE BUXY ergots déportés |                 |
| 479504         | SYM JET 2 temps  | Ø39.93x1.5mm    |
| 496758         | CPI EURO 2   KEEWAY ->2006 axe 12mm                            |                 |
| <b>4 temps</b> |  |                 |
| 478401         | OVETTO   NEOS   BOOSTER X   BOX   NITRO   AEROX                | Ø38mm           |
| 482205         | ZIP   FLY   LIBERTY   VESPA LX 50CC                            | Ø39mm           |
| 479503         | SYM MIO   ORBIT   VIVACITY 3   SPEEDFIGHT 3 et 4   TWEET       | Ø37mm           |



**SEGMENT MADE IN CEE (X2)**

|        |   |                 |
|--------|---|-----------------|
| 493271 | BOOSTER   NITRO   SR50   F12   OVETTO   STUNT   AEROX | épaisseur 1.2mm |
| 493272 | SPEEDFIGHT   TREKKER   BUXY   VIVACITY   TKR          | épaisseur 1.5mm |
| 493273 | TYPHOON   ZIP   NRG   STALKER   DNA   ICE   RUNNER    | épaisseur 1.4mm |
| 475181 | 4 temps CHINOIS 50CC   V CLIC   139QMB                | Ø39mm           |



**SEGMENT**

|        |   |    |
|--------|---|----|
| 169708 | BOOSTER   BW'S   STUNT   SLIDER   OVETTO   NEOS   NITRO   AEROX | x2 |
| 487953 | BOOSTER   BW'S pour piston 6 transferts                         | x2 |
| 487955 | SPEEDFIGHT LC   | x1 |
| 174741 | T6 103   FOX   FXR   SPEEDFIGHT liquide                         | x1 |
| 190611 | TYPHOON   ZIP   | x2 |
| 487954 | NRG MC2   RUNNER   ZIP LC                                       | x1 |







**DOPPLER**

## CAGE À AIGUILLE RENFORCÉE

|        |   |              |             |
|--------|---|--------------|-------------|
| 324259 | BOOSTER   NITRO   SR50   F12                    | 10x14x13mm   | jeu 0 à -2  |
| 461983 | BOOSTER   NITRO   SR50   F12                    | 10x14x13mm   | jeu -2 à -4 |
| 461984 | BOOSTER   NITRO   SR50   F12                    | 10x14x13mm   | jeu -4 à -6 |
| 451081 | TYPHOON   | 12x17x15mm   | jeu 0 à -2  |
| 324263 | TREKKER   DERBI   AM6     NITRO                 | 12x15x15mm   | jeu 0 à -2  |
| 461985 | TREKKER   SENDA   AM6   NITRO                   | 12x15x15mm   | jeu -2 à -4 |
| 461986 | TREKKER   SENDA   AM6   NITRO                   | 12x15x15mm   | jeu -4 à -6 |
| 324278 | TYPHOON   ZIP                                   | 12x17x13mm   | jeu 0 à -2  |
| 461991 | TYPHOON   ZIP                                   | 12x17x13mm   | jeu -2 à -4 |
| 496909 | LUDIX   KISBEE   DJANGO   SPEEDFIGHT 3   VIVA 3 | 12x16x15.5mm | jeu 0 à -2  |



## CAGE À AIGUILLE RENFORCÉE

|        |   |            |
|--------|---|------------|
| 252017 | BOOSTER   STUNT   OVETTO   NITRO   SR50   F12 | 10x14x13mm |
| 333484 | SPEEDFIGHT   TKR                              |            |



## CAGE À AIGUILLE

|        |   |            |
|--------|---|------------|
| 172055 | BOOSTER   NITRO   SR50   F12 cage INA               | 10x14x13mm |
| 467348 | LUDIX   KISBEE   DJANGO   SPEEDFIGHT 3   VIVACITY 3 | 12x16x16mm |
| 330246 | TYPHOON   SC80   SX80                               | 12x17x13mm |
| 478383 | CPI   KEEWAY 50CC EURO 2                            | 12x16x13mm |
| 330231 | AM6   SENDA   XP6   TREKKER   103                   | 12x15x15mm |



## CAGE À AIGUILLE RENFORCÉE

|        |                              |            |
|--------|------------------------------|------------|
| 480795 | BOOSTER   NITRO   SR50   F12 | 10x14x13mm |
| 480796 | LUDIX                        | 12x16x16mm |
| 480794 | AM6   SENDA   XP6   TREKKER  | 12x15x15mm |



## CLIP (X1)

193773 Ø12mm



## CLIP (X1)

461313 Ø12mm C



## CLIP

479498 Ø12mm G





**DOPPLER**

## PISTON ERI

|        |   |          |
|--------|---|----------|
| 436352 | AM6 vertex                                  | Ø40.24mm |
| 436276 | SENDA   GPR   DERBI VERTEX EURO 2 et EURO 3 | Ø39.84mm |



**DOPPLER**

## PISTON VORTEX

|        |   |          |
|--------|---|----------|
| 481154 | AM6 vertex 2 segments                       | Ø40.3mm  |
| 481155 | DERBI SENDA EURO 3 2006-> vertex 2 segments | Ø39.84mm |



## PISTON FONTE

|        |  |          |
|--------|--|----------|
| 479541 | AM6  | Ø40.3mm  |
| 479543 | DERBI   GPR   SENDA -> 2006 EURO 2 pour cylindre OLYMPIA | Ø39.93mm |



**DOPPLER ORIGIN**

## PISTON POUR CYLINDRE FONTE DOPPLER ORIGIN

|        |                                 |         |
|--------|---------------------------------|---------|
| 491309 | DERBI   SENDA   GPR EURO 2 et 3 |         |
| 491310 | AM6                             | Ø40.3mm |



## PISTON

|        |  |          |
|--------|--|----------|
| 465971 | AM6 alu  | Ø40.90mm |
| 490657 | AM6 pour cylindre fonte 486820                                     | Ø40.30mm |
| 494443 | DERBI   SENDA   GPR 2006-> EURO 3 bi-segments pour cylindre 492995 | Ø39.88mm |





**MALOSSI**

## PISTON

|        |                   |          |
|--------|-------------------|----------|
| 461300 | AM6               | Ø40.30mm |
| 461301 | DERBI SENDA   GPR | Ø39.88mm |



## PISTON

|        |   |          |
|--------|---|----------|
| 460521 | AM6   | Ø40.30mm |
| 460522 | AM6 côte réalésage                              | Ø40.60mm |
| 460523 | AM6 côte réalésage                              | Ø40.80mm |
| 481921 | DERBI EURO 3 SENDA   GPR (pour cylindre 480875) | Ø39.80mm |
| 460516 | DERBI EURO 2 SENDA   GPR                        | Ø39.85mm |



## PISTON ALU

|        |  |          |
|--------|--|----------|
| 467275 | AM6  | Ø40.30mm |
| 467274 | DERBI EURO 2 ADAPT. SENDA   GPR 2 segments, 1 en L | Ø40.28mm |
| 465477 | SENDA   GPR 1 segment                              | Ø40.00mm |



## PISTON

|        |   |          |
|--------|---|----------|
| 496323 | AM6                                     | Ø40.30mm |
| 496324 | DERBI EURO 2 SENDA   GPR cylindre fonte | Ø40.00mm |



## PISTON POUR CYLINDRE ORIGINE ET ADAPTABLE SAUF AIRSAL MADE IN CE

|        |                              |          |
|--------|------------------------------|----------|
| 459087 | AM6                          | Ø40.30mm |
| 478114 | DERBI SENDA EURO 2 et EURO 3 | Ø39.84mm |





**PISTON POUR CYLINDRE ORIGINE ET ADAPTABLE SAUF AIRSAL**

|        |                                    |                 |
|--------|------------------------------------|-----------------|
| 482577 | AM6 pour cylindre fonte            | Ø40.30mm        |
| 451399 | AM6 pour haut moteur alu           | Ø40.26mm        |
| 481626 | CPI SUPER MOTARD axe 12mm          | Ø40.00mm        |
| 482580 | DERBI SENDA EURO 2 et EURO 3   GPR | épaisseur 1.2mm |



**PISTON**

|        |                   |          |
|--------|-------------------|----------|
| 265825 | DERBI SENDA   GPR | Ø39.83mm |
| 450500 | SUZUKI RMX   SMX  | Ø40.94mm |



**SEGMENT ERI (X1)**

|        |                   |
|--------|-------------------|
| 324388 | AM6               |
| 324392 | DERBI SENDA   GPR |



**SEGMENT POUR PISTON VORTEX (X2)**

|        |                    |
|--------|--------------------|
| 481156 | AM6                |
| 481157 | DERBI SENDA EURO 3 |



**SEGMENT CYLINDRE FONTE (X2)**

|        |  |          |
|--------|--|----------|
| 479542 | AM6  | Ø40.30mm |
| 482542 | DERBI   GPR EURO2 pour piston OLYMPIA 479453 |          |





**DOPPLER** ORIGIN

| SEGMENT ORIGINE (X2) |   |          |
|----------------------|---|----------|
| 491311               | AM6 pour cylindre fonte                               | Ø40.30mm |
| 491313               | DERBI   SENDA   GPR ->2006 EURO 2 pour cylindre fonte |          |



| SEGMENT CHROME (X1) |                         |            |
|---------------------|-------------------------|------------|
| 2335                | AM6   BOOSTER évolution | Ø40.20x1mm |



| SEGMENT (X1) |                        |            |
|--------------|------------------------|------------|
| 461306       | AM6 compatible DOPPLER | Ø40.30x1mm |



| SEGMENT |  |              |    |
|---------|--|--------------|----|
| 460524  | AM6  | Ø40.30mm     | x2 |
| 460525  | AM6  | Ø40.60mm     | x2 |
| 460526  | AM6  | Ø40.80mm     | x2 |
| 467278  | AM6 pour cylindre alu                                  | Ø40.30x1.2mm | x1 |
| 460517  | DERBI SENDA   GPR segment supérieur en L               | Ø40.00mm     | x2 |
| 467277  | DERBI SENDA   GPR segment supérieur en L               | Ø40.28mm     | x2 |
| 481829  | DERBI SENDA   GPR 2006->   EURO 3 pour cylindre 480875 |              | x2 |
| 465478  | SENDA   GPR  | Ø40.00mm     | x2 |

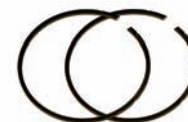

| SEGMENT (X2) |                                |          |
|--------------|--------------------------------|----------|
| 496326       | AM6                            | Ø40.30mm |
| 496327       | DERBI SENDA   GPR segment en L | Ø40.00mm |



| SEGMENT POUR CYLINDRE ALU ORIGINE ET ADAPTABLE SAUF AIRSAL (X2) |                   |                 |
|---|-------------------|-----------------|
| 455107  | AM6               | Ø40.30mm        |
| 482581  | DERBI SENDA   GPR | épaisseur 1.2mm |
| 455108  | DERBI SENDA   GPR | épaisseur 1.5mm |





### SEGMENT POUR CYLINDRE FONTE (X2)

|        |     |          |
|--------|-----|----------|
| 490449 | AM6 | Ø40.30mm |
|--------|-----|----------|



### SEGMENT (X2)

|        |   |                 |
|--------|---|-----------------|
| 493274 | AM6 pour cylindre origine et adaptable sauf airsals | Ø40.30x1.2mm    |
| 493276 | DERBI SENDA made in CEE pour cylindre origine       | épaisseur 1.2mm |



### SEGMENT (X2)

|        |                   |
|--------|-------------------|
| 265878 | AM6               |
| 265830 | DERBI SENDA   GPR |
| 450501 | SUZUKI RMX   SMX  |



### CAGE À AIGUILLE RENFORCÉE

|        |                                    |            |             |
|--------|------------------------------------|------------|-------------|
| 459124 | AM6                                | 12x16x15mm | jeu 0 à -2  |
| 461989 | AM6                                | 12x16x15mm | jeu -2 à -4 |
| 451081 | vilò DOPPLER endurance AM6   DERBI | 12x17x15mm | jeu 0 à -2  |
| 324263 | DERBI SENDA   AM6                  | 12x15x15mm | jeu 0 à -2  |
| 461985 | DERBI SENDA   AM6                  | 12x15x15mm | jeu -2 à -4 |
| 461986 | DERBI SENDA   AM6                  | 12x15x15mm | jeu -4 à -6 |



### CAGE À AIGUILLE RENFORCÉE

|        |                                      |            |
|--------|--------------------------------------|------------|
| 333484 | AM6   DERBI SENDA   SPEEDFIGHT   TKR | 12x17x13mm |
|--------|--------------------------------------|------------|



### CAGE À AIGUILLE RENFORCÉE

|        |  |              |
|--------|--|--------------|
| 478382 | AM6  | 12x15x16.5mm |
| 330231 | AM6   SENDA   XP6                              | 12x15x15mm   |
| 480794 | AM6   SENDA   XP6   TREKKER   renforcée argent | 12x15x15mm   |





**polini**  
motorcycle

### CLIP (X1)

193773 Ø12mm



**MALOSS**

### CLIP (X1)

461313 Ø12mm C



**TEKNIX**  
Original Quality Controller

### CLIP

479498 Ø12mm G



**DOPPLER**

### PISTON ERI

|        |        |          |
|--------|--------|----------|
| 436300 | 103    | Ø39.94mm |
| 268399 | 103    | Ø39.95mm |
| 441756 | MBK 51 | Ø38.95mm |



### PISTON

|        |                  |          |
|--------|------------------|----------|
| 493833 | CIAO PX axe 12mm | Ø38.40mm |
|--------|------------------|----------|



**MALOSS**

### PISTON

|      |                       |          |
|------|-----------------------|----------|
| 2295 | 103 air et liquide    | Ø39.94mm |
| 2300 | MBK 51 air et liquide | Ø39.94mm |



**TEKNIX**  
Original Quality Controller

### PISTON POUR CYLINDRE ORIGINE ET ADAPTABLE SAUF AIRSAL

|        |                  |            |
|--------|------------------|------------|
| 251139 | 103              | Ø39.88mm A |
| 192671 | 103              | Ø39.90mm C |
| 192686 | 103              | Ø39.91mm D |
| 192697 | 103              | Ø39.92mm E |
| 4110   | MBK 51           | Ø38.94mm A |
| 192743 | MBK 51           | Ø38.95mm C |
| 192762 | MBK 52           | Ø38.97mm G |
| 3244   | CIAO PX axe 10mm | Ø38.20mm C |



**AIRSAL**  
The power of engine
**PISTON POUR CYLINDRE**

|        |                     |
|--------|---------------------|
| 2292   | 103 6 transferts    |
| 269156 | MBK 51 6 transferts |

**DOPPLER**
**SEGMENT CYLINDRE ALU (X1)**

|        |                            |          |
|--------|----------------------------|----------|
| 193219 | MBK 51 acier double chrome | Ø39x1 mm |
| 193223 | 103 acier double chrome    | Ø40x1 mm |

**polini**  
motocycle
**SEGMENT (X1)**

|      |    |          |
|------|----|----------|
| 2329 | 51 | Ø39x1 mm |
|------|----|----------|

**MALOSSI**
**SEGMENT (X2)**

|      |     |            |
|------|-----|------------|
| 2325 | 103 | Ø40x1.5 mm |
|------|-----|------------|

**BIDALOT**
**SEGMENT CYLINDRE ALU (X1)**

|    |     |          |
|----|-----|----------|
| 95 | 103 | Ø40x1 mm |
|----|-----|----------|

**TEKNIX**  
Original Quality Controller
**SEGMENT POUR CYLINDRE ORIGINE ET ADAPTABLE SAUF AIRSAL**

|        |  |                 |    |
|--------|--|-----------------|----|
| 678    | 103  | épaisseur 1.5mm | x1 |
| 679    | 103 ancien modèle                                    | épaisseur 2.5mm | x1 |
| 4111   | MBK 40   50   88   89 MOTOBECANE   MBK ancien modèle | épaisseur 2mm   | x1 |
| 4112   | MBK 51   | épaisseur 2mm   | x1 |
| 479505 | SCIAO PX   | Ø38.2mm         | x2 |
| 3259   | CIAO PX 1ère gorge 1 segment en L                    | Ø38.2mm         | x1 |
| 3264   | CIAO PX 2ème gorge                                   | Ø38.20x1.5mm    | x1 |
| 4113   | SOLEX  | Ø39.50x1.7mm    | x1 |







**AIRSAL**  
The power of engine

**SEGMENT (X1)**

330432 MBK 51



**DOPPLER**

**CAGE À AIGUILLE RENFORCÉE**

|        |        |              |             |
|--------|--------|--------------|-------------|
| 372161 | 103    | 12x15x17.5mm | jeu 0 à -2  |
| 461979 | 103    | 12x15x17.5mm | jeu -2 à -4 |
| 324244 | MBK 51 | 13x16x14mm   | jeu 0 à -2  |
| 461981 | MBK 51 | 13x16x14mm   | jeu -2 à -4 |



Sélection  
**CGN**

**CAGE À AIGUILLE**

|        |                                 |              |
|--------|---------------------------------|--------------|
| 676    | 103                             | 12x15x17.5mm |
| 330231 | 103                             | 12x15x15mm   |
| 4121   | MBK 51 DAKOTA   KANSAS   PHENIX | 13x16x14mm   |



**TEKNIX**  
Original Quality Controller

**CAGE À AIGUILLE**

3255 CIAO PX | Ø10mm



**polini**  
motocycle

**CLIP (X1)**

193773 Ø12mm



**MALOSSI**

**CLIP (X1)**

461313 Ø12mm C



**TEKNIX**  
Original Quality Controller

**CLIP**

479498 Ø12mm G





**DOPPLER**

## CULASSE / CYLINDER HEAD

### CULASSE S1R

- 215082** TREKKER | SPEEDFIGHT | BUXY | VIVACITY | LUDIX | KISBEE air
- 215097** TYPHOON | ZIP | STALKER | FLY 50 2 temps
- 215078** BOOSTER | BW'S | STUNT | SLIDER | ROCKET cylindre fonte et alu (S1R/S1F)
- 215101** OVETTO | NEOS | SR50 | F12 | BIG MAX AIR



215082



215097



215078



215101

↳ Livré avec joint de culasse

**DOPPLER**

### CULASSE S1F

- 460456** NITRO | AEROX | SR50LC | F12LC | MACH G | JOG R | pour cylindre fonte
- 215078** BOOSTER | BW'S | STUNT | SLIDER | ROCKET cylindre fonte et alu (S1R/S1F)



460456



215078

↳ Livré avec joint de culasse

**DOPPLER** **ORIGIN**

### CULASSE TYPE ORIGINE

- 494640** BOOSTER | BW'S | STUNT | SLIDER | ROCKET | pour cylindre fonte et alu



# CULASSE / CYLINDER HEAD

MOTEUR



**TEKNIX**  
Original Quality Controller

## CULASSE

- 378490** BOOSTER | BW'S | STUNT | SLIDER | ROCKET | NEXT | NG
- 451717** NITRO | AEROX | SR50 | F12 LIQUIDE | MACH G type origine
- 480430** OVETTO | NEOS | FLIPPER | MACH G | JOG R | SR50
- 480431** TREKKER | SPEEDFIGHT | VIVACITY | BUXY | LUDIX | KISBEE toutes années
- 480432** TYPHOON | ZIP | STALKER | ICE | NRG air
- 485862** KEEWAY | CPI
- 480095** 50 SCOOT CHINOIS 4 | V CLIC 139QMB pour cylindre 39mm (livré avec soupapes)



378490

451717



480430

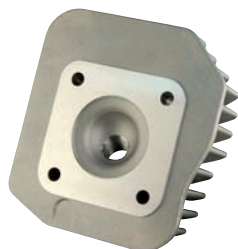

480431



480432



485862

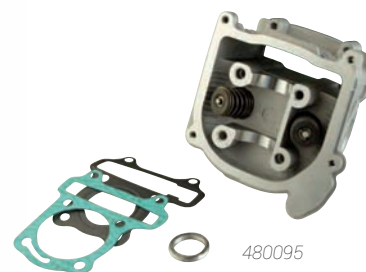

480095



## CULASSE

- 460482** BOOSTER | BW'S | STUNT | SLIDER | ROCKET | NG | NEXT



**TEKNIX**  
Original Quality Controller

## SOUPAPE

- 496278** 50 CHINOIS | VCLIC | GY6 | BAOTIAN | ORBIT | 139QMB (jeu)

Sélection  
**CGN**

## CHAÎNE DE DISTRIBUTION

- 468827** 4 temps CHINOIS V CLIC | 139QMB  
82 maillons



Sélection  
**CGN**

## JOINT DE TENDEUR CHAÎNE DE DISTRIBUTION

- 467724** SCOOTER CHINOIS 4 temps





**CULASSE VORTEX**

- 490484 AM6
- 488883 SENDA | GPR 2006-> D50BO nouveau modèle moteur PIAGGIO EURO 3



490484 488883

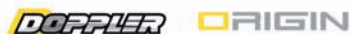

**CULASSE TYPE ORIGINE**

- 494090 AM6 TYPE 2001->
- 494091 DERBI | SENDA | GPR ->2006 EURO2
- 496867 DERBI EURO 3



494090 494091 496867



**CULASSE TYPE ORIGINE**

- 482626 AM6 | CPI | GENERIC | KSR 2001->
- 482627 DERBI | SENDA EURO 3 2006-> complète
- 482628 DERBI | SENDA EURO 2 ->2006



482626 482627 482628



**CULASSE**

- 491666 DERBI | SENDA | GPR 2006-> EURO 3



**CULASSE TYPE ORIGINE**

- 460520 AM6 | CPI | GENERIC | KSR POUR MOTEUR FONTE
- 460515 DERBI | SENDA EURO 2 ->2006



460520 460515

# CULASSE / CYLINDER HEAD



**DOPPLER**

## CULASSE ERI

- 192270 C103 | FOX | SPX | MVL | VOGUE | SPX | RCX | WALLAROO livré sans joint
- 192246 MBK 51 air DAKOTA livrée sans joint



192270



192246

**MALOSSI**

## CULASSE ERI

- 2436 103 | MVL | VOGUE | SPX | RCX | WALLAROO avec décompresseur
- 2437 103 | FOX | MVL | VOGUE | SPX | RCX | WALLAROO sans décompresseur



2436



2437

**TEKNIX**  
Original Quality Controller

## CULASSE TYPE ORIGINE

- 671 103 | MVL | VOGUE | SPX | RCX | WALLAROO avec décompresseur
- 4115 MBK 51 | DAKOTA | PHENIX avec décompresseur moteur AV10
- 480969 MBK 88/89 avec décompresseur moteur AV7



671



4115



480969

**TEKNIX**  
Original Quality Controller

## DÉCOMPRESSEUR

- 672 103
- 4145 MBK 51/88



672



4145

**polini**  
motocross

## BOUCHON DE DÉCOMPRESSEUR

- 2450 103





**INFO + :**

Retrouvez la pâte à joint **page 629.**



**JOINT MOTEUR (POCHETTE)**

|        |  |     |
|--------|--|-----|
| 122776 | BOOSTER   BW'S   STUNT   SLIDER                              | x11 |
| 252677 | NITRO   AEROX   SR50LC   F12 liquide                         | x7  |
| 122787 | OVETTO   EVOLIS   SR50 air                                   | x10 |
| 121712 | TREKKER   SPEEDFIGHT air   BUXY                              | x8  |
| 479347 | BUXY   VIVACITY   TKR   FIGHT 2 air et liquide               | x9  |
| 479346 | LUDIX   VIVACITY 3   SPEEDFIGHT 3   JET FORCE air et liquide | x6  |
| 483636 | SCOOTER CHINOIS GY6 50CC roue 10" et 12"                     | x13 |



**JOINT MOTEUR (POCHETTE)**

|        |                                    |     |
|--------|------------------------------------|-----|
| 460600 | BOOSTER   BW'S   STUNT   SLIDER    | x9  |
| 460603 | NITRO   AEROX   SR50   F12 liquide | x10 |



**JOINT SPI MOTEUR (POCHETTE)**

|        |                                       |    |
|--------|---------------------------------------|----|
| 460596 | BOSSTER   BW'S   NITRO   AEROX   SR50 | x6 |
|--------|---------------------------------------|----|



**JOINT SPI MOTEUR (POCHETTE)**

|      |         |    |
|------|---------|----|
| 4144 | BOOSTER | x4 |
|------|---------|----|



**BOUCHON VIDANGE, CRÉPINE ET JOINT**

|        |                                    |
|--------|------------------------------------|
| 483637 | SCOOTER CHINOIS GY6 139QMB 152 QMI |
|--------|------------------------------------|





**AFARTEIN**  
gaskets

### JOINT HAUT MOTEUR (POCHETTE)

|        |  |    |
|--------|--|----|
| 451433 | BOOSTER   BW'S   STUNT   SLIDER                        | x4 |
| 451436 | NITRO   AEROX   SR50   F12 liquide                     | x5 |
| 481914 | OVETTO   NEOS   FLIPPER   CPI 2 temps                  | x3 |
| 481913 | LUDIX   VIVACITY 3   SPEEDFIGHT 3   KISBEE 2 temps air | x3 |
| 482059 | LUDIX BLASTER   JET FORCE   SPEEDFIGHT 3 liquide       | x4 |
| 451438 | SPEEDFIGHT liquide                                     | x4 |
| 451435 | TREKKER   BUXY   ZENITH   SPEEDFIGHT   VIVACITY        | x3 |
| 451434 | TYPHOON   STALKER   ZIP   ICE                          | x3 |
| 483696 | SUZUKI KATANA 50CC                                     | x4 |
| 482053 | CPI   KEEWAY 50CC 2 temps FOCUS   MATRIX   HURRICANE   | x4 |
| 476914 | KYMCO AGILITY 4 TEMPS                                  | x5 |
| 483697 | KYMCO COBRA   DINK   TOP BOY 50CC 2 temps              | x3 |
| 451437 | NRG   DNA   RUNNER   SR50 2005->   ZIP liquide         | x7 |



**TEKNIX**  
Original Quality Controller

### JOINT HAUT MOTEUR (POCHETTE)

|        |   |     |
|--------|---|-----|
| 169909 | BOOSTER   BW'S   STUNT   SLIDER   ROCKET                              | x4  |
| 254889 | NITRO   AEROX   SR50   F12   MACH G   JOG R                           | x5  |
| 369795 | OVETTO   NEOS   SR50   EVOLIS   BIG MAX   MACH G   JOG R              | x4  |
| 460009 | SPEEDFIGHT liquide  | x6  |
| 478436 | TREKKER   SPEEDFIGHT   VIVACITY air et liquide                        | x9  |
| 176725 | TREKKER   SPEEDFIGHT   BUXY   ZENITH   VIVACITY                       | x5  |
| 465949 | LUDIX   SPEEDFIGHT 3   VIVACITY 3   KISBEE 2 temps haut moteur TEKNIX | x3  |
| 465937 | LUDIX   SPEEDFIGHT 3   VIVACITY 3   KISBEE 2 temps air                | x3  |
| 465938 | LUDIX BLASTER   JETFORCE   SPEEDFIGHT 3 liquide                       | x3  |
| 254874 | NRG   RUNNER ancien modèle  | x3  |
| 475159 | NRG   RUNNER   DNA   ZIP liquide   SR50 2005-> nouveau modèle         | x14 |
| 479350 | BOX   BOOSTER X   NEOS   OVETTO   VINO   NITRO   AEROX 4 temps        | x5  |
| 482346 | KYMCO AGILITY 4 temps   | x3  |
| 479349 | SYM ORBIT   MIO 50CC 4 temps  | x4  |
| 485176 | SYM JET 2 temps   | x3  |
| 468201 | 4 temps CHINOIS 50CC 139QMB   | x3  |

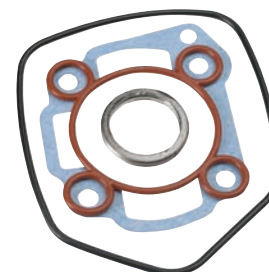

**DOPPLER**

### JOINT HAUT MOTEUR

|        |  |       |
|--------|--|-------|
| 441810 | NITRO   AEROX   SR50LC   F12 liquide S1F | alu   |
| 451436 | NITRO   AEROX   SR50   F12 liquide S1R   | fonte |

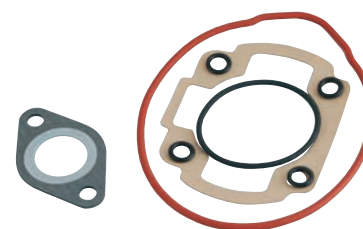

JOINT / GASKET

MOTEUR



**DOPPLER**

## JOINT HAUT MOTEUR

|        |   |       |
|--------|---|-------|
| 450033 | NRG   RUNNER cylindre ER1w              | alu   |
| 491314 | BOOSTER   BW'S   STUNT   SLIDER origine | fonte |

## JOINT / GASKET

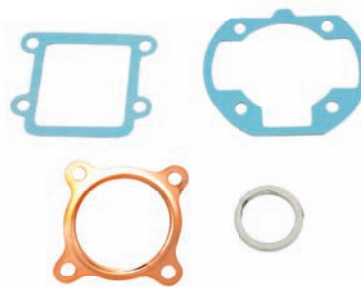

## JOINT HAUT MOTEUR (POCHETTE)

|        |  |    |
|--------|--|----|
| 460487 | BOOSTER   BW'S   STUNT   SLIDER                | x3 |
| 467252 | BOOSTER   BW'S   STUNT   SLIDER                | x5 |
| 460497 | NITRO   AEROX   SR50   F12   MACH G   JOG R    | x3 |
| 467254 | OVETTO   NEOS   SR50   F12   BIG MAX           | x5 |
| 460493 | SR50   F12   BIG MAX   OVETTO   NEOS           | x2 |
| 476290 | LUDIX   SPEEDFIGHT 3   VIVACITY 3              | x3 |
| 484334 | SPEEDFIGHT   VIVACITY   TREKKER   BUXY         | x2 |
| 460500 | TYPHOON   ZIP   STALKER   ICE culasse origine  | x5 |
| 460504 | RUNNER   NRG   SR50 2005->   DNA   ZIP liquide | x7 |
| 476289 | KEEWAY   CPI                                   | x2 |
| 492682 | SPEEDFIGHT 1 et 2 liquide                      | x9 |

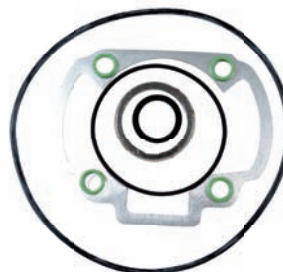

## JOINT HAUT MOTEUR FONTE (POCHETTE)

|        |  |    |
|--------|--|----|
| 192815 | BOOSTER   BW'S   STUNT   SLIDER   ROCKET   NEXT   NG | x4 |
| 214757 | NITRO   AEROX   SR50   F12   MACH G   JOG R          | x9 |
| 2353   | TREKKER   SPEEDFIGHT air   BUXY   VIVACITY air       | x3 |
| 214731 | TYPHOON   ZIP   STALKER   ICE                        | x2 |
| 368382 | SPEEDFIGHT liquide                                   | x9 |

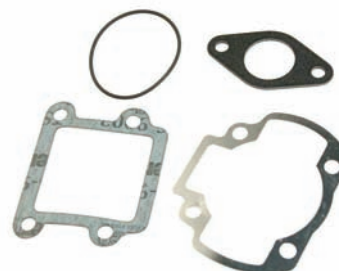

## JOINT HAUT MOTEUR (POCHETTE)

|        |  |    |
|--------|--|----|
| 479531 | LUDIX BLASTER   SPEEDFIGHT 3   JET FORCE liquide         | x4 |
| 449734 | SPEEDFIGHT liquide                                       | x4 |
| 465935 | SR 2000   KATANA   MORINI LC   SKEGGIA   BENELLI liquide | x8 |
| 492123 | PIAGGIO ZIP   FLY 4 temps                                | x8 |

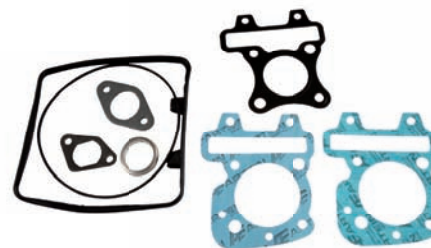



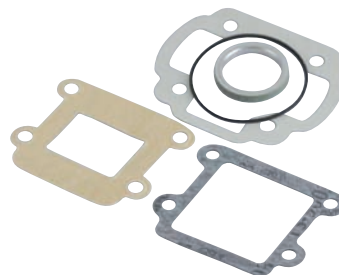

**MALOSSI**
**JOINT HAUT MOTEUR (POCHETTE)**

|        |  |    |
|--------|--|----|
| 2360   | BOOSTER   BW'S   STUNT   SLIDER   ROCKET                       | x5 |
| 318190 | NITRO   AEROX   SR50LC   F12 liquide                           | x4 |
| 2359   | OVETTO   NEOS   SR50 air   F12   BIG MAX   MAC G   JOG R air   | x3 |
| 465943 | alu LUDIX   SPEEDFIGHT 3   VIVACITY 3   KISBEE 2 temps air     | x3 |
| 214693 | TREKKER   SPEEDFIGHT air   BUXY   VIVACITY   TREKKER   TKR air | x3 |
| 2345   | NRG   RUNNER   SR50 05->   ZIP liquide   DNA MHR liquide       | x3 |
| 208290 | TYPHOON   ZIP   STALKER   ICE                                  | x2 |

**JOINT HAUT MOTEUR FONTE (POCHETTE)**

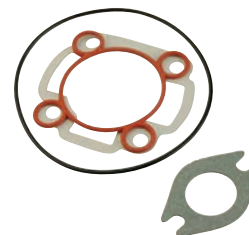
|        |   |    |
|--------|---|----|
| 479547 | NITRO   AEROX   MACH G   JOG R   SR50   F12 | x4 |
| 479548 | SPEEDFIGHT liquide                          | x5 |

 Sélection  
**CGN**
**JOINT DE TENDEUR DE CHAÎNE**

|        |                         |
|--------|-------------------------|
| 467724 | SCOOTER CHINOIS 4 temps |
|--------|-------------------------|

**DOPPLER**
**JOINT CYLINDRE/EMBASE SIR/SIF**

|        |  |
|--------|--|
| 214951 | BOOSTER   BW'S   STUNT   SLIDER                              |
| 214985 | NITRO   AEROX   OVETTO   NEOS   SR50   F12   BIG MAX   JOG R |

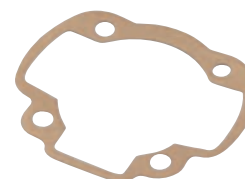
**TEKNIX**  
 Original Quality Controller

**JOINT CYLINDRE/EMBASE**

|        |  |
|--------|--|
| 4136   | BOOSTER   BW'S   STUNT   SLIDER   ROCKET               |
| 214880 | NITRO   SR50   OVETTO   EVOLIS   BIG MAX               |
| 467229 | LUDIX   SPEEDFIGHT 3   VIVACITY 3   KISBEE   JET FORCE |
| 172165 | TREKKER   SPEEDFIGHT air   BUXY   ZENITH               |
| 192982 | TYPHOON   ZIP   STALKER   ICE                          |
| 467719 | SCOOTER CHINOIS 50CC   V CLIC 139QMB 4 temps           |





## JOINT CYLINDRE/EMBASE

460501 TYPHOON | ZIP | STALKER



## JOINT DE CULASSE

4135 BOOSTER | BW'S | STUNT | SLIDER | ROCKET  
 467228 BUXY | LUDIX | TREKKER | SPEEDFIGHT | VIVACITY  
 487166 NITRO | AEROX | SR50LC | F12LC | MACH G liquide  
 4140 OVETTO | NEOS | F12 | BIG MAX | MACH G | JOG R

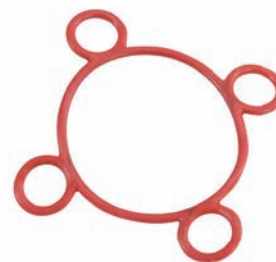

## JOINT CARTER MOTEUR

|        |  |             |
|--------|--|-------------|
| 482771 | LUDIX   SPEEDFIGHT 3   VIVACITY          | air/liquide |
| 482768 | SPEEDFIGHT   BUXY   TREKKER   VIVACITY 2 | air         |
| 484135 | BOOSTER   STUNT   BW'S   SLIDER   ROCKET |             |
| 484555 | NITRO   AEROX   OVETTO   NEOS            |             |
| 482773 | BUXY   TREKKER   VIVACITY                |             |
| 482774 | LUDIX   JET   SPEEDFIGHT 3               |             |



## JOINT CARTER TRANSMISSION

4134 BOOSTER | BW'S | NITRO | AEROX | STUNT | SLIDER  
 467722 SCOOTER CHINOIS 4 temps

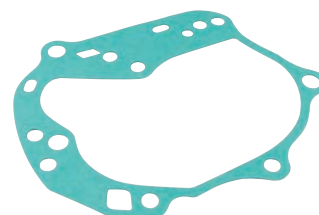

## JOINT CARTER KICK/VARIATEUR

484193 KYMCO AGILITY | VITALITY 4 TEMPS | V-C  
 268441 NITRO | AEROX | SR50 | F12  
 4133 BOOSTER | BW'S | STUNT | ROCKET

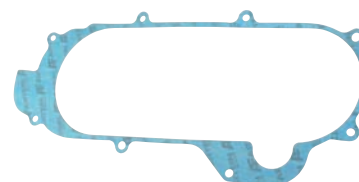



Sélection  
**CGN**

### JOINT ÉCHAPPEMENT

|        |  |
|--------|--|
| 467231 | LUDIX   VIVACITY 3   SPEEDFIGHT 3   KISBEE 2T   DJANGO       |
| 176744 | BOOSTER   SR50   F12 (bride)                                 |
| 173893 | BOOSTER   SR50   F12 rond 26.2X32.6X4.6                      |
| 467230 | LUDIX   VIVACITY 3   SPEEDFIGHT 3   KISBEE 2T   DJANGO air   |
| 701    | SPEEDFIGHT   TREKKER   BUXY   VIVACITY   DAKOTA 25.85   33.7 |
| 485884 | KEEWAY   CPI (3 trous)                                       |
| 440825 | A bride renforcée (fixation ouverte)                         |
| 489831 | JOINT POT SCOOTER dimension 31mm extérieur 24mm intérieur    |



173893



467230



701



485884



467231



176744



440825



489831

**DOPPLER**

### JOINT BOÎTE À CLAPET SIR

|        |                                |
|--------|--------------------------------|
| 440681 | BOOSTER   BWS   STUNT   SLIDER |
|--------|--------------------------------|



Sélection  
**CGN**

### JOINT CLAPET

|        |   |
|--------|---|
| 4138   | BOOSTER   BWS   STUNT   SLIDER   ROCKET               |
| 484338 | BUXY   SP EEDFIGHT   TREKKER   VIVACITY               |
| 481340 | NITRO   A EROX   MACH G   JOG R   NEOS   OVETTO   F12 |



**ARTEIN**

### JOINT CLAPET

|        |   |
|--------|---|
| 482775 | BUXY   SPEEDFIGHT   TREKKER   VIVACITY 2  |
| 482777 | LUDIX   JET FORCE   SPEEDFIGHT 3   KISBEE |



**BIDALOT**

### JOINT CYLINDRE EMBASE

|        |                             |
|--------|-----------------------------|
| 173362 | TREKKER   SPEEDFIGHT   BUXY |
|--------|-----------------------------|





**JOINT PIPE**

- 472122 SCOOTER CHINOIS 50CC | V CLIC | 139QMB 4 temps
- 479368 BUXY | SPEEDFIGHT | TREKKER | VIVACITY x2
- 479369 ZIP | TYPHOON | STALKER | RUNNER | FLY 2 temps

**JOINT / GASKET**



**JOINT SPI VILO (EN TEFLON)**

- 495858 BOOSTER | BW'S | STUNT | NITRO | AEROX | OVETTO
- 495857 TYPHOON | NRG | STALKER | ZIP | DNA | ICE

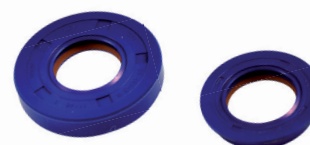

**JOINT SPI VILO**

- 329853 BOOSTER | BW'S | STUNT | ROCKET | NITRO
- 479576 BUXY | TREKKER | VIVACITY 1 et 2 | SPEEDFIGHT
- 467233 LUDIX | VIVACITY 3 | SPEEDFIGHT 3 | JET
- 483722 SCOOTER CHINOIS 139QMB 25x44
- 329868 SPEEDFIGHT | TREKKER | BUXY | VIVACITY
- 329891 TYPHOON | NRG | STALKER | ZIP | DNA | ICE
- 479579 BOOSTER | NITRO | OVETTO | MACH G | OVETTO
- 479577 LUDIX | JET FORCE | VIVACITY 3 | SPEEDFIGHT
- 479578 TYPHOON | STALKER | ZIP | FLY 2 temps | NRG | ICE



**JOINT SPI VILO TYPE ORIGINE**

- 460597 BOOSTER | NITRO | SR50





## JOINT HAUT MOTEUR

|        |   |
|--------|---|
| 451440 | AM6   CPI   GENERIC   KSR 2000-> (pochette) |
| 451439 | RS50   AM6 ->2000 (pochette)                |
| 467344 | DERBI SENDA 2006-> EURO 3                   |
| 467347 | DERBI SENDA ->2006 EURO 2 (pochette)        |
| 440925 | DERBI SENDA   GPR (pochette) EURO 2         |
| 467345 | SUZUKI   SMX   RMX 50 (pochette)            |



## JOINT HAUT MOTEUR

|        |   |
|--------|---|
| 450502 | SUZUKI SMX   RMX CYL ALU                                      |
| 450555 | AM6   CPI   GENERIC   KSR 2001-> NM pochette                  |
| 329906 | AM6   CPI   GENERIC   KSR ->2000 AM pochette                  |
| 472507 | DERBI SENDA 2006-> EURO 3 3 pièces                            |
| 475160 | DERBI SENDA 2006-> EURO 3 5 pièces                            |
| 482345 | DERBI SENDA ->2006 EURO 2 4 pièces                            |
| 455415 | DERBI SENDA   GPR EURO 2 ->2006 pour cylindre 220384 pochette |
| 475681 | SUZUKI SMX   RMX pochette                                     |



## JOINT HAUT MOTEUR VORTEX

|        |                           |
|--------|---------------------------|
| 480615 | AM6                       |
| 480614 | DERBI SENDA 2006-> EURO 3 |

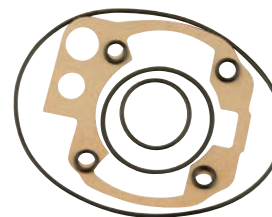

## JOINT HAUT MOTEUR ERI

|        |                                 |
|--------|---------------------------------|
| 367386 | RS50   AM6                      |
| 477553 | DERBI SENDA 2006-> EURO 3       |
| 367397 | DERBI SENDA   GPR ->2006 EURO 2 |

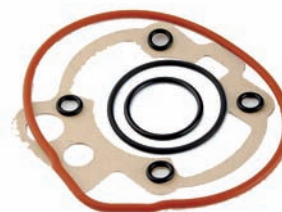



## JOINT HAUT MOTEUR

|        |  |       |           |
|--------|--|-------|-----------|
| 467262 | AM6 (pochette) alu                           | alu   | 14 joints |
| 460527 | AM6 (pochette) fonte                         | fonte | 8 joints  |
| 482534 | SENDA   GPR   DERBI 2006-> EURO fonte        | fonte | 13 joints |
| 465479 | SENDA   GPR   DERBI ->2006 EURO 2 alu        | alu   | 8 joints  |
| 461199 | DERBI SENDA/GPR ->2006 EURO 2 pochette fonte | fonte | 7 joints  |
| 460518 | SENDA   GPR EURO 2 pochette fonte            | fonte | 3 joints  |

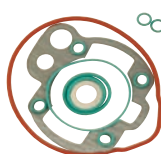

467262



460527

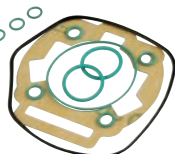

482534

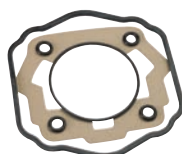

465479

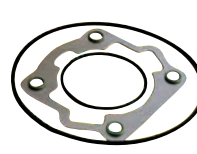

461199



460518



## JOINT HAUT MOTEUR

|        |  |
|--------|--|
| 465952 | AM6 pochette                             |
| 450050 | DERBI SENDA   GPR pochette EURO 2 ->2006 |

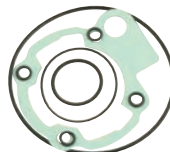

465952

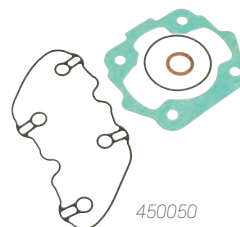

450050



## JOINT HAUT MOTEUR

|        |                                     |
|--------|-------------------------------------|
| 265859 | AM6 (cylindre 220399) alu           |
| 482001 | DERBI SENDA 2006-> EURO 3 alu       |
| 265844 | SENDA   GPR   DERBI (pochette) EURO |

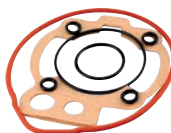

265859

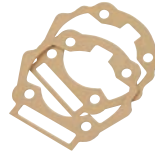

482001

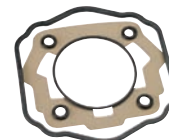
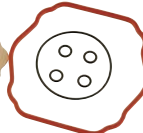

265844



## JOINT HAUT MOTEUR

|        |  |
|--------|--|
| 461326 | AM6 (pochette)                           |
| 475333 | DERBI SENDA   GPR 2006-> EURO 3 pochette |
| 461319 | DERBI SENDA   GPR ->2006 EURO 2 pochette |

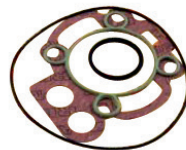

461326

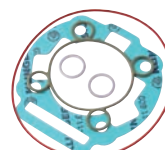

475333

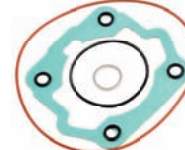

461319



## JOINT HAUT MOTEUR

|        |                                   |
|--------|-----------------------------------|
| 479549 | AM6                               |
| 479546 | DERBI   GPR   SENDA ->2006 EURO 2 |

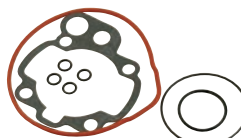

479549



479546



**DOPPLER**

## JOINT HAUT MOTEUR ORIGINE

- 491305 AM6 Ø40.3mm pour cylindre fonte
- 491307 DERBI | SENDA | GPR ->2006
- 491306 DERBI | SENDA | GPR 2006->

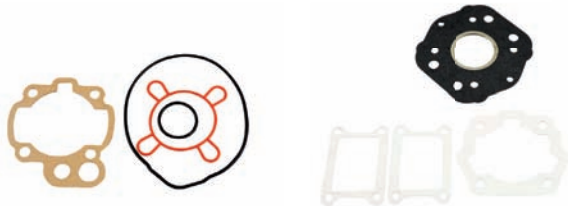

491305

491307

**BIDALOT**

## JOINT HAUT MOTEUR

- 467688 DERBI SENDA | GPR 2006-> EURO 3
- 441335 RS50 | AM6



467688

441335

**polini**

## JOINT HAUT MOTEUR FONTE

- 494442 DERBI | SENDA | GPR 2006-> EURO 3

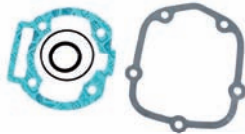

**TEKNIX**  
Original Quality Controller

## JOINT CULASSE

- 487169 AM6 extérieur
- 487170 AM6 ->2001 torique goujon x1
- 487168 DERBI | SENDA | GPR 2006-> EURO 3



487169

487170

487168

**TEKNIX**  
Original Quality Controller

## JOINT CYLINDRE/EMBASE

- 467561 AM6 | CPI | GENERIC | KSR
- 440254 DERBI SENDA | GPR ->2006 EURO 2
- 487167 DERBI SENDA | GPR 2006-> EURO 3

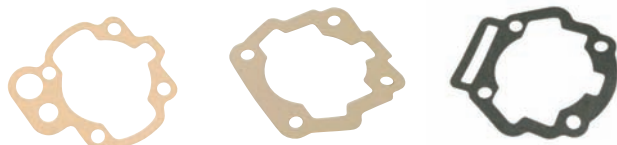

467561

440254

487167

**ARTEIN**

## JOINT CYLINDRE/EMBASE

- 482779 DERBI | SENDA | GPR | RX50 | RS4 2006->



**TOP**  
- performance -

## JOINT CARTER EMBRAYAGE

- 460632 AM6 type origine



**TEKNIX**  
Original Quality Controller

## JOINT CARTER EMBRAYAGE

- 475683 AM6
- 479920 SENDA | GPR | DERBI 2006-> EURO 3



475683

479920



**ARTEIN**  
gaskets

## JOINT CARTER EMBRAYAGE

**482055** SENDA | DERBI | GPR 2006-> EURO 3

**482054** SENDA | GPR | DERBI ->2006 EURO 2

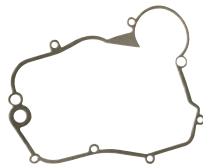

482055



482054

**TEKNIX**  
Original Quality Controller

## JOINT CARTER ALLUMAGE

**484768** AM6

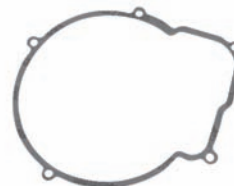

**TEKNIX**  
Original Quality Controller

## JOINT CARTER MOTEUR

**329045** SENDA | GPR | FENIX | DERBI ->2006 EURO 2

**479921** SENDA | GPR | FENIX | DERBI ->2006 EURO 3

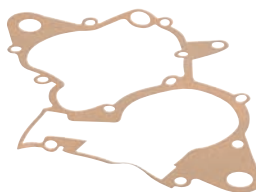

329045



479921

**DOPPLER**

## JOINT CLAPET

**450119** AM6 pour clapet DOPPLER

**450117** AM6 pour pipe DOPPLER côté pipe

**450120** DERBI SENDA | GPR pour clapet DOPPLER

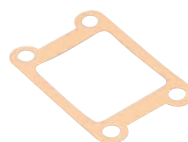

**ARTEIN**  
gaskets

## JOINT CLAPET

**482057** DERBI SENDA EURO 2 et 3

**482056** DERBI | SENDA | GPR EURO 2 et 3 côté pipe

**482058** AM6

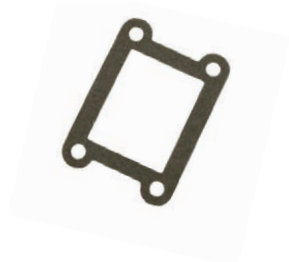

Sélection  
**CGN**

## JOINT CLAPET

**479367** AM6 côté pipe

x2

**329050** DERBI SENDA | GPR | RS 2006-> | RS4 | SMT | RCR | RX50

**479366** SENDA | DERBI | GPR côté

x2







**TEKNIX**  
Original Quality Controller

## JOINT POMPE À EAU TYPE ORIGINE

- 475684 AM6
- 475686 DERBI | SENDA 2006->
- 475685 DERBI | SENDA->2006



## JOINT CORPS POMPE À EAU TYPE ORIGINE

- 460620 RS50 | AM6



## JOINT POMPE À EAU TYPE ORIGINE

- 460629 AM6



## JOINT SPI POMPE À EAU TYPE ORIGINE

- 460630 AM6 10x18x8mm



## JOINT CULASSE

- 493616 AM6 SENDA extérieur VORTEX
- 195427 45x2.5mm

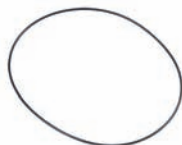

## JOINT CULASSE

- 482060 AM6 2001-> intérieur
- 440255 DERBI | SENDA | GPR ->2006 EURO 2
- 487171 DERBI | SENDA | GPR 2006 -> EURO 3

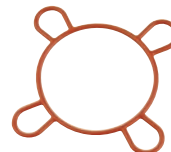

## JOINT MOTEUR

- 482052 AM6 ->2000 x8
- 482051 AM6 2000-> x8
- 482050 DERBI SENDA | GPR 2006-> EURO 3

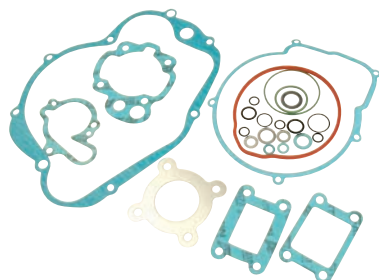

## JOINT MOTEUR

- 292354 AM6
- 335453 DERBI SENDA | GPR ->2005 EURO 2
- 475157 DERBI SENDA | GPR 2006-> EURO 3





**JOINT ECHAPPEMENT**

489254 AM6 sortie cylindre Ø28 torique x1

497121 AM6 sortie cylindre Ø25 torique x1



**JOINT SILENCIEUX/CARTOUCHE**

493953 ER1 | ER2 | GP8.0 | WR7 | LEOVINCE universel



**JOINT SILENCIEUX/CARTOUCHE**

481465 SCOOTER YASUNI | BIDALOT



**JOINT SPI MOTEUR**

472540 AM6 kit complet

472541 DERBI SENDA ->2005 complet

475156 DERBI SENDA 2006-> complet



**JOINT SPI VILO EN TEFLON**

479859 AM6

479860 DERBI | SENDA | GPR





**TEKNIX**  
Original Quality Controller

## JOINT SPI VILO (X2)

|        |                             |
|--------|-----------------------------|
| 329917 | AM6 VITON                   |
| 329079 | DERBI SENDA   GPR   FENIX   |
| 479575 | DERBI   SENDA   GPR 20x35x7 |



## JOINT SPI VILO TYPE ORIGINE (X2)

|        |     |
|--------|-----|
| 468136 | AM6 |
|--------|-----|



Sélection  
**CGN**

## JOINT BOUCHON VIDANGE (X1)

|        |                                  |         |
|--------|----------------------------------|---------|
| 483805 | AM6 cuivre                       | 8x12mm  |
| 484774 | DERBI SENDA   GPR<br>EURO 2 et 3 | 10x18mm |
| 495309 | cuivre                           | 12x20mm |
| 495308 | cuivre                           | 14x20mm |
| 495310 | cuivre                           | 16x22mm |



Sélection  
**CGN**

## JOINT TORIQUE BOUCHON HUILE

|        |                    |
|--------|--------------------|
| 497488 | DERBI SENDA EURO 3 |
|--------|--------------------|



**TEKNIX**  
Original Quality Controller

## JOINT MOTEUR

|        |                    |
|--------|--------------------|
| 171355 | 103 (pochette)     |
| 171347 | MBK 51 (pochette)  |
| 3269   | CIAO PX (pochette) |

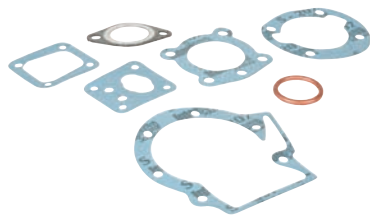

**DOPPLER**

## JOINT HAUT MOTEUR

|        |                 |
|--------|-----------------|
| 450452 | ER1 103 liquide |
|--------|-----------------|



**MALLOSSI**

## JOINT HAUT MOTEUR

|        |                        |
|--------|------------------------|
| 214708 | 103 air (pochette)     |
| 2247   | 103 liquide (pochette) |
| 461316 | MBK 51 air (pochette)  |



**AFARTEIN**

## JOINT HAUT MOTEUR

|        |                      |
|--------|----------------------|
| 451442 | FOX   103 (pochette) |
|--------|----------------------|





## JOINT HAUT MOTEUR

|        |                           |
|--------|---------------------------|
| 329930 | FOX   103 (pochette)      |
| 479357 | MBK 51                    |
| 4123   | MBK 51 LIQUIDE (pochette) |
| 490338 | MBK 88   AV7              |

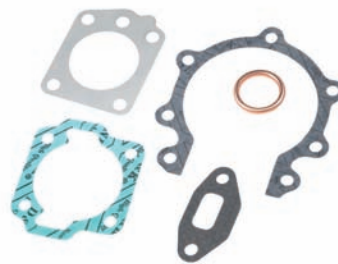

## JOINT HAUT MOTEUR

|        |                        |
|--------|------------------------|
| 214765 | 103 air (pochette)     |
| 2252   | 103 LIQUIDE (pochette) |

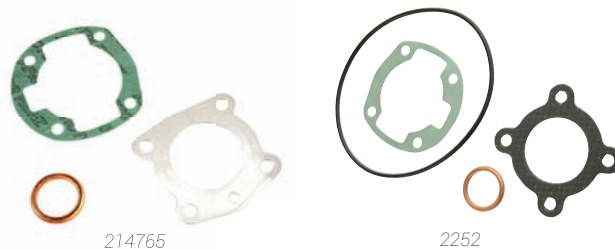

## JOINT CULASSE

|      |                        |
|------|------------------------|
| 2361 | 103 (renforcé)         |
| 686  | 103 liquide (pochette) |
| 681  | 103                    |
| 4125 | MBK 51   88            |

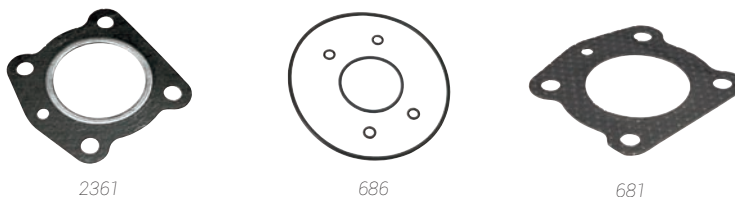

## JOINT CULASSE

|     |                            |
|-----|----------------------------|
| 529 | 103 liquide torique 45x2.5 |
|-----|----------------------------|



## JOINT CULASSE

|        |        |
|--------|--------|
| 195427 | 45x2.5 |
|--------|--------|



## JOINT CULASSE

|        |            |
|--------|------------|
| 214990 | ER1 103    |
| 215006 | ER1 MBK 51 |





**TEKNIX**  
Original Quality Controller

## JOINT CYLINDRE/EMBASE

|      |            |
|------|------------|
| 4127 | MBK 51     |
| 4128 | MBK 88 AV7 |
| 3265 | CIAO PX    |
| 683  | 103        |



4127



683

Sélection  
**CGN**

## JOINT ÉCHAPPEMENT

|     |   |
|-----|---|
| 766 | 103 (bride)                             |
| 764 | 103   51 MBK (cuivre) (22.80x29.9x3.86) |



766



764

**polini**  
motor

## JOINT CARTER MOTEUR (POCHETTE)

|      |                              |
|------|------------------------------|
| 2348 | 103 pour carter avec support |
| 2347 | 103 pour carter avec support |
| 2350 | MBK 51                       |

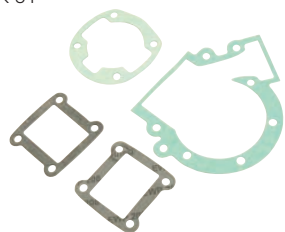

**TEKNIX**  
Original Quality Controller

## JOINT CARTER MOTEUR (POCHETTE)

|      |                         |
|------|-------------------------|
| 685  | 103                     |
| 4131 | 88 MBK AV7              |
| 4130 | MBK 51   41 MOTEUR AV10 |



Sélection  
**CGN**

## JOINT CARTER MOTEUR (POCHETTE)

|      |                  |
|------|------------------|
| 636  | 103 côté pipe    |
| 638  | 103   TOMOS      |
| 4066 | MBK 51           |
| 4064 | MBK 51 côté pipe |



**BIDALOT**

## JOINT HAUT MOTEUR

|     |             |
|-----|-------------|
| 105 | 103 liquide |
|-----|-------------|



Sélection  
**CGN**

## JOINT PIPE

|      |            |
|------|------------|
| 4065 | MBK 88 AV7 |
|------|------------|



**DOPPLER**

## JOINT SILENCIEUX, CARTOUCHE, POT CYLINDRE

|        |         |
|--------|---------|
| 450360 | S3R ER1 |
|--------|---------|





## JOINT SPI VILO

|        |  |
|--------|--|
| 495859 | MBK 51   88   41   CADI   89   DAKOTA   PHENIX |
| 495860 | PEUGEOT 103 en téflon                          |



## JOINT ÉTANCHÉITÉ

|        |                              |
|--------|------------------------------|
| 484833 | cuivre (coffret panaché 400) |
|--------|------------------------------|

# JOINT / GASKET



## JOINT SPI VILO

|      |  |
|------|--|
| 3960 | 103 droit                                      |
| 3938 | 103 gauche                                     |
| 3268 | CIAO PX  |
| 4143 | MBK 51   88   41   CADI   89   DAKOTA   PHENIX |



## JOINT PLAT KIT 195X475

|        |                |                              |
|--------|----------------|------------------------------|
| 440922 | carton pressé  | 0.30mm   0.50mm (x2)   0.8mm |
| 440921 | gomme de liège | 1.00mm   1.50mm   2.00mm     |
| 440924 | mat armé       | 0.80mm   1.20mm              |
| 440923 | papier huile   | 0.15mm   0.25mm   0.50mm     |

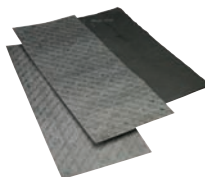

440922

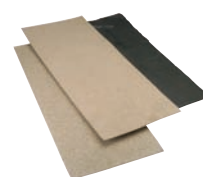

440921

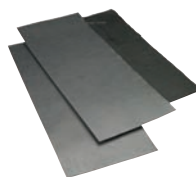

440924



440923



## JOINT PLAT FEUILLE A4 21X19.7CM

|        |                 |        |
|--------|-----------------|--------|
| 485074 | alu             | 0.35mm |
| 485070 | papier          | 0.3mm  |
| 485071 | papier          | 0.5mm  |
| 485072 | papier fibre    | 0.5mm  |
| 485073 | papier graphite | 1.2mm  |



485074

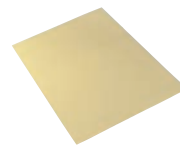

485070



485071



485072



485073

**POMPE À EAU**

478397 complet SPEEDFIGHT avec carter

**MÉCANISME DE POMPE À EAU**

478706 OVETTO | NEOS | BOOSTER X | AEROX | NITRO 4 temps

451085 NITRO | AEROX | SR50 | F12 | MACH G | JOG R | SR50

460080 NRG | ZIP SP | DNA | SR50 2005-&gt; | RUNNER

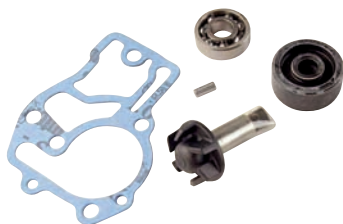

478706



451085



460080

**MÉCANISME DE POMPE À EAU TYPE ORIGINE**

460604 NITRO | AEROX | SR50 | F12 | MACH

**PIÈCES DÉTACHÉES POMPE À EAU TYPE ORIGINE**

482845 joint pion, silentbloc NITRO | AEROX | MACH G | JOG R | SR50 | F12

482844 pion métal NITRO | AEROX | F12 | MACH G | SR50

482843 poulie NITRO | SR50 LC | F12 LC | F15 | MACH G liquide

460606 roulement NITRO | SR50 | F12 | NRG | RUNNER 8x22x7mm liquide

460605 turbine pompe à eau NITRO | SR50 | F12 | AEROX | MACH G | SR50



482845



482844



482843



460606



460605



**VASE D'EXPANSION EAU AVEC BOUCHON**

496102 NITRO | AEROX



**BOUCHON VASE D'EXPANSION EAU**

496103 NITRO | AEROX



**CALORSTAT**

482348 NITRO | AEROX | F12 | MACH G | JOG R | SR50

482347 NRG | DNA | RUNNER



**RADIATEUR**

478901 NITRO | AEROX ->2013

478724 SPEEDFIGHT 1 et 2



478901



478724



## REFROIDISSEMENT / COOLING

MOTEUR



### PAIRE DURITE EAU SILICONE

|        |                                      |
|--------|--------------------------------------|
| 483922 | NITRO   AEROX   MACH G   JOG R bleu  |
| 483923 | NITRO   AEROX   MACH G   JOG R rouge |
| 483924 | SPEEDFIGHT 2 bleu                    |
| 483925 | SPEEDFIGHT 2 rouge                   |



483922



483923



483924



483925



### CACHE CYLINDRE ET CULASSE TYPE ORIGINE

|        |                                 |
|--------|---------------------------------|
| 467263 | BOOSTER   BW'S   STUNT   SLIDER |
| 467264 | OVETTO   SR50   EVOLIS   MACH G |



467263



467264



### CACHE CYLINDRE ET CULASSE

|        |  |
|--------|--|
| 484561 | TREKKER   SPEEDFIGHT   VIVACITY   BUXY               |
| 485864 | CPI   KEEWAY   |
| 494815 | SCOOTER CHINOIS   139QMB   GY6 avec cache et turbine |
| 451401 | BOOSTER   BW'S   STUNT   SLIDER noir                 |
| 473343 | BOOSTER   BW'S   STUNT   SLIDER blanc                |



484561



485864



494815



451401



473343



### CACHE TURBINE

|        |   |             |
|--------|---|-------------|
| 472596 | BOOSTER   BW'S 2004->   STUNT   SLIDER 2004-> | noir        |
| 472595 | BOOSTER   BW'S 2004->   STUNT   SLIDER 2004-> | carbone     |
| 472597 | BOOSTER   BW'S 2004->   STUNT   SLIDER 2004-> | blanc       |
| 294964 | BOOSTER   BW'S   STUNT   SLIDER               | noir        |
| 294926 | BOOSTER   BW'S   STUNT   SLIDER               | carbone     |
| 294911 | BOOSTER   BW'S   STUNT   SLIDER               | chrome      |
| 460331 | BOOSTER   BW'S   STUNT   SLIDER               | blanc       |
| 488399 | LUDIX CARBONE MAT                             | carbone mat |
| 462485 | LUDIX   | noir        |
| 473454 | TYPHOON   STALKER   ZIP                       | noir        |



472596



472595



472597



294911



488399



### CACHE TURBINE TYPE ORIGINE

- 460593 BOOSTER | BW'S noir
- 460594 OVETTO | NEOS | JOG R | SR50 noir



460593



460594



### CACHE TURBINE

- 485866 KEEWAY | CPI
- 487508 SCOOTER CHINOIS 50CC | V CLIC | 139QMB 4 temps



485866



487508



### TURBINE ALLUMAGE

- 485867 CPI | KEEWAY
- 485664 GY6 | AGILITY 4 temps
- 460339 BOOSTER | BW'S | STUNT | SLIDER | OVETTO | NEOS blanc brut



485867



485664



460339



### POMPE À HUILE

- 478709 BOOSTER | STUNT | MACH G | OVETTO | NITRO | SR50 | F12
- 482624 BOOSTER | BW'S | NITRO | AEROX | SR50 | CPI 3 débits
- 487108 SPEEDFIGHT 2 | VIVACITY | TKR | LUDIX électrique
- 484652 SCOOTER CHINOIS GY6 | 139QMB | AGILITY | KISBEE | VCLIC 4 temps
- 483619 AM6 | TYPHOON | ZIP | STALKER | NRG | SR50 2005-> | DNA | ICE



### Pignon plastique

- 483816 BOOSTER | BW'S | NITRO | SR50 | STUNT | OVETTO



478709



482624



487108



484652



483619



483816

**COURROIE POMPE À HUILE**

467699 TYPHOON | NRG | ET2 | ZIP | FLY | STALKER | RUNNER | SR50

**OBTURATEUR POMPE À HUILE**

489446 BOOSTER | STUNT | NITRO | OVETTO | titane

**BOUCHON REMPLISSAGE HUILE, JAUGE**

485938 SCOOTER CHINOIS GY6 139QMB

**MÉCANISME DE POMPE À EAU**

476426 SENDA | GPR | RS | RS4 | RX 2006-&gt; DERBI EURO 3

460082 SENDA | GPR -&gt;2006 DERBI EURO 2



476426



460082

**MÉCANISME DE POMPE À EAU TYPE ORIGINE**

460618 AM6

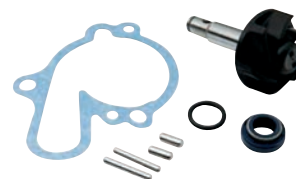
**PIÈCES DÉTACHÉES POMPE À EAU TYPE ORIGINE**

467259 axe AM6 avec turbine

467260 corps AM6

467258 axe/pion centrage corps AM6

460620 joint RS50 | AM6

460629 joint AM6 thorique 11,8x2,4

460630 joint SPI AM6 10x18x8

460623 raccord AM6



467259

467260

467258

460620

460629

460630

460623



**JOINT COUVERCLE POMPE À EAU TYPE ORIGINE**

- 475685** DERBI SENDA ->2006 EURO 2
- 475686** DERBI SENDA 2006-> EURO 3
- 475684** AM6



475685



475686



475684



**CALORSTAT**

- 482348** AM6 | CPI | GENERIC | KSR
- 482347** DERBI | SENDA | GPR | RS4



482348



482347



**RADIATEUR**

- 494801** CPI | KEEWAY | GENERIC | THORN
- 481837** DERBI SENDA | RX50 2000->



494801



481837



**PAIRE DURITE EAU SILICONE**

- 493173** DERBI SENDA EURO 3 bleu
- 493174** DERBI SENDA EURO 3 rouge



493173



493174

**TEKNIX**  
Original Quality Controller
**SONDE TEMPÉRATURE**
**494804** CPI | GENERIC | KSR | KEEWAY | RIDE

**494805** GENERIC | KSR RIDE THORN

494804



494805

**DELORE**
**POMPE À HUILE**
**494373** AM6 PLBD38

**494374** DERBI EURO 2-PLBS35

494373



494374

**DOPPLER**
**OBTURATEUR POMPE À HUILE**
**479558** AM6 | SENDA argent

**479560** AM6 | SENDA blanc

**479555** AM6 | SENDA bleu

**479557** AM6 | SENDA noir

**479561** AM6 | SENDA or

**479556** AM6 | SENDA rouge

**479559** AM6 | SENDA titane

**484382** AM6 | SENDA orange

**484381** AM6 | SENDA vert

479558



479560



479555



479557



479561



479556



479559



484382



484381



Sélection  
**CGN**

## DURITE EAU

2262 12x19mm longueur 1.50m



**TUN'R**

## REFROIDISSEUR

|        |             |        |
|--------|-------------|--------|
| 477401 | court carré | argent |
| 477402 | court carré | blanc  |
| 477400 | court carré | noir   |
| 477404 | long rond   | argent |

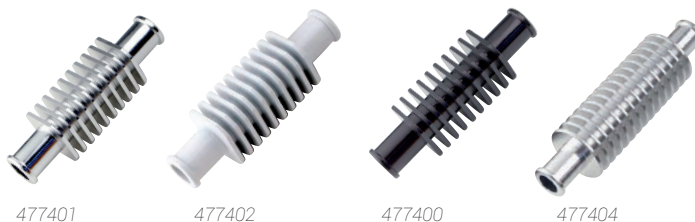

**polini**  
motociclisti

## COURROIE POMPE À EAU

|      |  |
|------|--|
| 2259 | courroie cyclo                             |
| 2263 | raccord radiateur Ø6mm embout durite vissé |

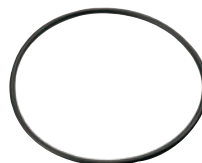

2259



2263

Sélection  
**CGN**

## COLLIER DURITE DE REFROIDISSEMENT/EAU

|        |                        |    |
|--------|------------------------|----|
| 483093 | Ø16 à 27mm largeur 9mm | x1 |
| 483094 | Ø25 à 40mm largeur 9mm | x1 |
| 493926 | DERBI SENDA EURO 3     | x4 |



483093

483094

493926

Sélection  
**CGN**

## DURITE POMPE À HUILE

|        |                    |
|--------|--------------------|
| 210387 | 2x4mm longueur 10m |
| 494862 | 3x5mm longueur 10m |



NOUVELLE SÉRIE POUR SCOOTER

# YASUNI CHROME BLACK



**YASUNI**®

PERFORMANCE EXHAUST TECHNOLOGY



## POT TYPE ORIGINE

**DOPPLER**

### POT PREMIUM

|        |   |
|--------|---|
| 472315 | BOOSTER   STUNT   BW'S   SLIDER   NG   ROCKET               |
| 472316 | NITRO   AEROX   NEOS   OVETTO   MACH G   JOG R   F12   SR50 |
| 472322 | BUXY   SPEEDFIGHT   VIVACITY   TREKKER   TKR                |
| 472317 | PIAGGIO TYPHOON   STALKER   NRG   ICE                       |



**SITO**

### POT

|        |  |
|--------|--|
| 476451 | BOOSTER   BW'S ->2004 (catalysé) STUNT   SLIDER   NEXT   NG   ROCKET |
| 451621 | NITRO   AEROX ->2003   |
| 461177 | NITRO   AEROX 2004->   |
| 481413 | NEOS 2 temps 2004->   OVETTO   |
| 461204 | LUDIX   VIVACITY 3   SPEEDFIGHT 3 4   KISBEE   CITYSTAR AIR          |
| 482538 | SPEEDFIGHT 2 AIR   LIQUIDE   |
| 482537 | SPEEDFIGHT AIR   LIQUIDE 1997/1999                                   |
| 482539 | VIVACITY 1999->2002  |
| 476202 | KYMCO VITALITY 50   SYM EUROJET 2 temps                              |
| 477289 | PIAGGIO ZIP   FLY 50 4 temps   |
| 472548 | DERBI ATLANTIS (moteur PIAGGIO air) 2003->2006                       |



**LeoVince**

### POT TOURING

|        |   |
|--------|---|
| 478888 | BOOSTER   BW'S ->2004   STUNT   SLIDER                |
| 478889 | NITRO   AEROX   MACH G   JOG R   F12   SR50           |
| 478890 | NEOS 2 temps   OVETTO   MACH G   JOG R                |
| 485626 | LUDIX ONE   KISBEE   CITYSTAR (2 temps)               |
| 478891 | SPEEDFIGHT 1 et 2   TKR   VIVACITY 2   TREKKER 1 et 2 |
| 478893 | TYPHOON   NRG   STALKER   SR50 2005->   DNA   ICE     |
| 478892 | ZIP 50 2009-> 2 temps                                 |







## POT TYPE ORIGINE



### POT SITO +

|        |   |
|--------|---|
| 460986 | BOOSTER   BW'S 2004->   |
| 4165   | BOOSTER SPIRIT   NG ->2003  |
| 322720 | NEOS 2 temps ->2003   OVETTO  |
| 465912 | LUDIX BLASTER   JET FORCE C TECH 2005->   SPEEDFIGHT 3 2009->             |
| 214617 | TYPHOON->2002   NRG   ZIP avec coude                                      |
| 322734 | TYPHOON   RUNNER   STALKER   NRG   ZIP SP avec pipe et silencieux         |
| 477783 | PIAGGIO ZIP 2009->   TYPHOON 2011->   SR50 MOTARD 2011->   VARIANT 2011-> |
| 467698 | VESPA 50 ET2   LX 2T  |
| 464924 | LIBERTY 4 temps   VESPA   LX 4 temps ( 50CC )                             |
| 320966 | SR50 AIR   LIQUIDE MOTEUR MINA 1997->2002                                 |
| 490501 | RUNNER PUR JET 2008->   ZIP   SR FACTORY (moteur PIAGGIO carbu)           |
| 265753 | TREKKER   SPEEDFIGHT   VIVACITY   SQUAB   TKR                             |
| 472418 | ADAPT CPI   KEEWAY   GENERIC  |
| 478339 | KYMCO AGILITY 50R12 4 temps 2008->  |



### POT ECO

|        |   |
|--------|---|
| 496690 | LUDIX   VIVACITY 3   SPEEDFIGHT 3 4 AIR   CITYSTAR   KISBEE 2 temps |
| 491392 | NITRO   AEROX   OVETTO   NEOS   MACH G   JOG R                      |
| 491393 | BOOSTER   BW'S   STUNT   SLIDER                                     |
| 491394 | TREKKER   SPEEDFIGHT   VIVACITY 1 et 2   TKR                        |
| 491395 | KYMCO COBRA   DINK   SUPER 9   PEOPLE   SPACER                      |
| 491396 | TYPHOON   NRG   STALKER   DNA   ICE   SR50 2005->   ZIP ->2008      |
| 491397 | SUZUKI KATANA   APRILA SR50 (motorisation MORINI)                   |



### POT CTI

|        |   |
|--------|---|
| 478751 | BOOSTER   BW'S   STUNT   SLIDER                             |
| 478752 | NITRO   AEROX   OVETTO   NEOS   MACH G   JOG R              |
| 478754 | LUDIX   VIVACITY 3   SPEEDFIGHT 3 4 AIR   CITYSTAR   KISBEE |
| 478753 | TYPHOON   NRG   STALKER   SR50 2005->   ICE   DNA   RUNNER  |
| 479056 | VIVACITY 1 et 2   TREKKER   SPEEDFIGHT 1 et 2 TRR           |





## POT TYPE ORIGINE

**tecnigas**

### POT SILENT PRO

|        |  |
|--------|--|
| 473227 | BOOSTER   BW'S   STUNT   SLIDER tout modèle                                |
| 473226 | NITRO   AEROX   OVETTO   NEOS 2 temps   MACH G   JOG R                     |
| 473223 | LUDIX   VIVACITY 3   CITYSTAR   KISBEE 2 temps                             |
| 473224 | SPEEDFIGHT   TREKKER   BUXY   VIVACITY   TKR                               |
| 473230 | TYPHOON   STALKER   FLY   ZIP   ICE   NRG 2 temps                          |
| 473225 | KYMCO AGILITY 4 temps  |
| 473229 | KYMCO   SYM 2 temps  |
| 483137 | SYM MIO   ORBIT 2 4 temps   LUDIX   VIVACITY 3   SPEEDFIGHT 3 et 4 4 temps |
| 483214 | SYM FIDDLE II N.M 4 temps  |
| 473228 | CPI OLIVER   HUSSARD KEEWAY F-ACT   RY6   MATRIX                           |
| 475314 | DAELIM S.FIVE  |
| 491063 | KISBEE 4 temps   S4 DEALIM   |
| 487590 | PEUGEOT TWEET 50   SYM SYMPHONY  |



**polini**  
EXHAUST

### POT ORIGINAL

|        |   |
|--------|---|
| 487423 | LUDIX AIR ET LIQUIDE   VIVACITY 3   SPEEDFIGHT 3 4   KISBEE 2 temps |
| 487424 | VIVACITY   TREKKER   SPEEDFIGHT   SQUAB   BUXY                      |
| 487420 | TYPHOON   NRG   STALKER   RUNNER   DNA   ICE   SR50                 |
| 487419 | VESPA ET2 LX  |
| 487522 | CPI   KEEWAY  |
| 493003 | KYMCO AGILITY   VITALITY   DINK   SYM JET 4 temps                   |
| 493326 | SYM FIDDLE 2 4 temps   PEUGEOT KISBEE 4 temps                       |
| 493327 | SPEEDFIGHT 3 et 4   VIVACITY 3 4 temps                              |





## POT DE DÉTENTE



### POT RR7 VERNI SILENCIEUX TITANE

|        |   |
|--------|---|
| 477298 | NITRO   AEROX   MACH G   JUG R   OVETTO   NEOS                              |
| 477297 | BOOSTER   STUNT   BW'S   SLIDER   |
| 477300 | LUDIX   VIVACITY 3   SPEEDFIGHT 3 et 4   KISBEE   CITYSTAR AC et LC 2 temps |
| 477299 | SPEEDFIGHT 1 et 2   TREKKER   VIVACITY 1 et 2   TKR                         |
| 477301 | TYPHOON   STALKER   NRG   ICE   |



↳ La bride de fixation du modèle pour LUDIX est montée folle pour s'adapter aussi bien au moteur à refroidissement liquide qu'à air



### POT S3R ÉVOLUTION VERNI

| Modèle   | Silencieux alu poli | Silencieux noir | Silencieux blanc | Silencieux carbone |
|--|---------------------|-----------------|------------------|--------------------|
| BOOSTER   BW'S   STUNT   SLIDER   NG   ROCKET   NEXT                 | 265241              | 475216          | 475219           | 493840             |
| CPI   KEEWAY   | 476296              |                 |                  | 493843             |
| LUDIX   VIVACITY 3   SPEEDFIGHT 3 et 4   KISBEE   CITYSTAR   AC   LC | 461206              | 475380          | 475379           | 493842             |
| NITRO   AEROX   OVETTO   NEOS   MACH G   JOG R   SR MINARELLI   F12  | 265275              | 475217          | 475220           | 493841             |
| SPEEDFIGHT 1 et 2   VIVACITY 1 et 2   TREKKER   TKR                  | 265280              | 475218          | 475221           | 493844             |
| TYPHOON   STALKER   NRG   DNA   ICE RUNNER                           | 265267              |                 |                  | 493845             |

↳ Monté sur rotule permettant une adaptation sur EURO 2 et EURO 3



265241



475216



475379



493844



## POT DE DÉTENTE

**DOPPLER**
**POT S3R CHROME**

|        |  |
|--------|--|
| 462173 | BOOSTER   STUNT   BW'S   SLIDER                |
| 462175 | NITRO   AEROX   MACH G   JOG R   OVETTO   NEOS |

**LeoVince**
**POT TT**

| Modèle   | Silencieux alu poli | Silencieux noir |
|--|---------------------|-----------------|
| BOOSTER   BW'S ->2003   STUNT   SLIDER                       | 458254              | 495782          |
| BOOSTER   BW'S 2004->  | 460404              | 495786          |
| CPI   KEEWAY   |                     | 495788          |
| JET FORCE   LUDIX BLASTER   FIGHT 3 LIQUIDE                  |                     | 495791          |
| JET FORCE   LUDIX BLASTER   SPEEDFIGHT 3 liquide             | 461787              |                 |
| KYMCO AGILITY   VITALITY SYM JET 50 2 temps                  |                     | 495789          |
| KYMCO AGILITY   VITALITY SYM EURO JET 50 2 temps             | 466537              |                 |
| LUDIX   VIVA3   FIGHT 3 4   KISBEE   CITYSTAR AIR            |                     | 495784          |
| LUDIX   VIVACITY 3   SPEEDFIGHT 3 4   KISBEE   CITYSTAR air  | 460405              |                 |
| NITRO   AEROX ->1999   | 461277              |                 |
| NITRO   AEROX 2000-> catalysé                                | 461278              | 495785          |
| SPEEDFIGHT   | 458256              |                 |
| TREKKER   METAL X   VIVACITY   BUXY M   SQUAB                | 458257              | 495783          |
| TYPHOON   NRG   NTT   RUNNER   STALKER   TYPHOON             |                     | 495790          |
| TYPHOON   NRG   NTT   RUNNER   STALKER   TYPHOON   DNA   ICE | 458255              |                 |
| TYPHOON   ZIP FAST RIDER                                     | 458261              |                 |
| ZIP   TYPHOON 2 temps 2009->                                 |                     | 495787          |



495782



460404

**LeoVince**
**POT**

|        |   |
|--------|---|
| 477790 | KYMCO AGILITY 50 4 temps (R12) 2008->                           |
| 480616 | PEUGEOT V CLIC   KYMCO 50 4 temps AGILITY R10   DINK   LA POSTE |





## POT DE DÉTENTE

### YASUNI

#### POT R

|   | Silencieux argent | Silencieux noir | Silencieux kevlar | Silencieux carbone |
|---|-------------------|-----------------|-------------------|--------------------|
| BOOSTER   BW'S   STUNT   SLIDER                           | 472447            | 478980          | 472451            | 476734             |
| NITRO   AEROX   OVETTO   NEOS   MACH G   JOG R            | 472446            | 478981          | 472450            | 476733             |
| TREKKER   SPEEDFIGHT   VIVACITY                           | 472448            | 478982          |                   |                    |
| LUDIX   VIVACITY 3   SPEEDFIGHT 3 4   CITYSTAR KISBEE air | 477222            |                 |                   | 477223             |
| TYPHOON   NRG   STALKER   DNA   ICE   SR50 05->           | 472449            | 478983          | 472453            |                    |



472447



478980



472451



476734

### YASUNI

#### POT Z

|   | Silencieux argent | Silencieux noir | Silencieux carbone | Chrome silencieux noir |
|---|-------------------|-----------------|--------------------|------------------------|
| BOOSTER   BW'S   STUNT   SLIDER                         | 472487            | 478984          | 476728             | 497568                 |
| NITRO   AEROX   OVETTO   NEOS   JOG R   MACH G          | 472486            | 478985          | 476730             | 497570                 |
| TREKKER   SPEEDFIGHT   VIVACITY                         | 472488            | 478986          | 476731             |                        |
| TYPHOON->2000   NRG   STALKER   DNA   SR50 2005->   ICE | 472489            |                 |                    | 497569                 |



472487



478984



476731



497569



## POT DE DÉTENTE

## BIDALOT

## POT SIR CHROMÉ

|        |  |
|--------|--|
| 461375 | BOOSTER   BW'S   STUNT   SLIDER                |
| 461377 | NITRO   AEROX   OVETTO   NEOS   MACH G   JOG R |



## BIDALOT

## POT SIR VERNI

|        |   |
|--------|---|
| 461374 | BOOSTER   BW'S   STUNT   SLIDER                         |
| 461376 | NITRO   AEROX   OVETTO   NEOS   MACH G   JOG R          |
| 461378 | LUDIXVIVACITY 3   SPEEDFIGHT 3 4   KISBEE   CITYSTAR AI |



## tecnigas

## POT NEXT R VERNI

|        |   |
|--------|---|
| 450556 | BOOSTER   BW'S   STUNT   SLIDER                     |
| 450559 | NITRO   AEROX   OVETTO   NEOS   JOG R MACH G   SR50 |
| 479474 | SPEEDFIGHT 3   VIVACITY 3   LUDIX   JET   CITYST    |
| 450558 | BUXY ->1998   ZENITH ->1998                         |
| 480464 | PGO BIG MAX   HOT   COMET   MEGA   TORNADO   PMX    |
| 450557 | TYPHOON   NRG   DNA   STALKER   RUNNER              |



## tecnigas

## POT GP4

|        |  |
|--------|--|
| 486257 | PEUGEOT TWEET   SYM SYMPHONY   SYM JET 4 temps                 |
| 486258 | PIAGGIO ZIP 4 temps   LIBERTY 4 temps   FLY 4 temps (hors 4 V) |
| 483217 | AGILITY   VITALITY   SUPER   V CLIC   BOATIAN   139QMB CHINOIS |





## POT DE DÉTENTE

**tecnigas**

### POT Q-TRE VERNI

|        |   |
|--------|---|
| 486968 | BOOSTER   BW'S   STUNT   SLIDER                         |
| 486970 | NITRO   AEROX   OVETTO   NEOS 2 temps                   |
| 486972 | SPEEDFIGHT 3   VIVACITY 3   LUDIX   JET FORCE   CITYSTA |
| 486973 | TYPHOON   STALKER   NRG   ZIP   RUNNER   FLY            |
| 486971 | TREKKER   SPEEDFIGHT   VIVACITY   SQUAB                 |
| 486974 | CPI OLIVER   HUSSARD KEEWAY F-ACT   RY6   MATRIX        |



## ACCESSOIRE

**DOPPLER**

### PIÈCES DÉTACHÉES POT RR7

|        |   |   |
|--------|---|---|
| 478306 | silencieux/cartouche titane                               | tout modèle   |
| 449897 | collier silencieux Ø60mm + caoutchouc                     | tout modèle   |
| 481737 | joint pot torique (entre coude et corps) x1               | tout modèle   |
| 481736 | joint pot silencieux torique (entre pot et silencieux) x1 | tout modèle   |
| 481424 | patte pot (complète)                                      | BOOSTER   BW'S   STUNT   NITRO   AEROX   OVETTO   NEOS              |
| 481425 | patte pot (complète)                                      | TKR   SPEEDFIGHT   VIVACITY   |
| 481426 | patte pot   | TYPHOON   NRG   DNA   ICE   SR50 ->05   STALKER   LUDIX   JET FORCE |
| 481734 | ressort pot x1  | longueur 70mm   |
| 481735 | ressort pot silencieux x1                                 | court 55mm  |



478306



449897

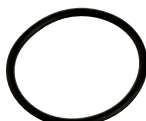

481737



481736

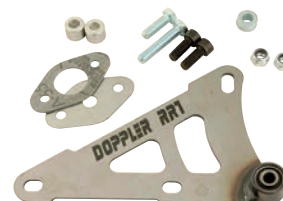

481424

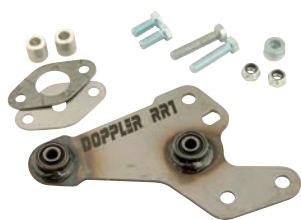

481425

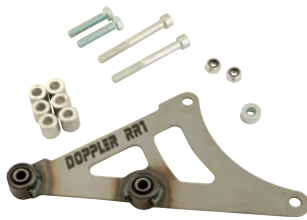

481426



481734



481735

ACCESSOIRE



PIÈCES DÉTACHÉES POT S3R

|        |                                       |   |
|--------|---------------------------------------|---|
| 368359 | silencieux/cartouche alu poli Ø60mm   | tout modèle   |
| 477364 | silencieux/cartouche blanc Ø60mm      | tout modèle   |
| 477365 | silencieux/cartouche noir Ø60mm       |   |
| 449897 | collier silencieux Ø60mm + caoutchouc |   |
| 450360 | joint silencieux                      | compatible NINJA   GIANNELLI                              |
| 440891 | patte pot (complète)                  | BOOSTER   BW'S   NITRO   AEROX   SR50   F12               |
| 440892 | patte pot (complète)                  | TYPHOON   NRG   SR50 2005->   STALKER   LUDIX   JET FORCE |
| 440893 | patte pot (complète)                  | SPEEDFIGHT   TREKKER   VIVACITY                           |

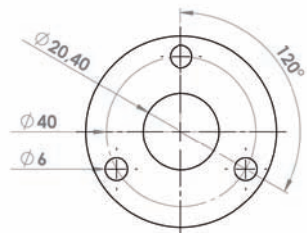

368359



477364



477365



449897



450360



440891



440892



440893



## ACCESSOIRE



### PIÈCES DÉTACHÉES POT S3R MONTAGE UNIVERSEL

|        |                                     |
|--------|-------------------------------------|
| 487658 | silencieux/cartouche alu poli Ø60mm |
| 487659 | silencieux/cartouche carbone Ø60mm  |

- ↳ Entraxe 3 points pour Doppler
- ↳ Entraxe 2 points pour Bidalot, Yasuni
- ↳ Entraxe 3 points 41-42mm Leovince TT

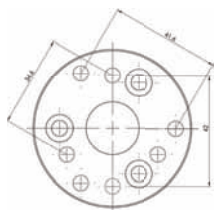

487658



487659



### PIÈCES DÉTACHÉES TT

|        |   |
|--------|---|
| 458743 | silencieux/cartouche alu poli 3 fixations Ø40mm                   |
| 497367 | silencieux/cartouche alu ploi 3 fixations Ø40mm noir              |
| 1726   | joint silencieux/cartouche 3 trous x1                             |
| 173525 | collier silencieux Ø60mm RS   TT   R   Z   G1   TOP ONE   FOR ONE |

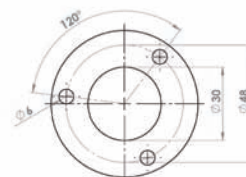

458743



497367



1726



173525



### PIÈCES DÉTACHÉES POT PLUS

|        |  |
|--------|--|
| 483660 | joint (entre pipe d'échappement et pot) x1 STALKER pour pot 322734 |
|--------|--|



ACCESSOIRE

**YASUNI**

**PIÈCES DÉTACHÉES POT**

- 480617 silencieux/cartouche Ø60mm 2 vis noir
- 472823 silencieux/cartouche Ø60mm 2 vis argent
- 484823 silencieux/cartouche Ø60mm 2 vis carbone
- 472824 silencieux/cartouche Ø60mm 2 vis kevlar
- 481465 joint silencieux x1
- 477225 patte pot BOOSTER | BW'S | STUNT | SLIDER
- 481634 ressort silencieux Ø9mm 1.8x52
- 481464 silentbloc patte de pot

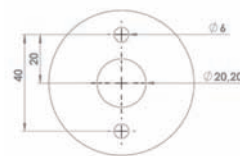

480617



472823



484823



472824



481465



477225



481634



481464

**YASUNI**

**PIÈCES DÉTACHÉES POT Z**

- 477224 patte pot | BOOSTER | BW'S | STUNT | SLIDER



## ACCESSOIRE

### BIDALOT

#### PIÈCES DÉTACHÉES POT S1R | SR3

|        |                               |   |
|--------|-------------------------------|---|
| 465915 | silencieux/cartouche bleu     | Ø60mm S1R   |
| 468110 | collier silencieux Ø60mm      | S1R   S3R   |
| 468160 | joint silencieux              | S1R   S3R   MXR   |
| 472476 | silentbloc patte de pot (jeu) | S1R   S3R   |
| 468160 | joint silencieux              | S1R   S3R   MXR   |
| 476255 | patte pot                     | S1R   S3R   NITRO   AEROX   BOOSTER   BW'S   OVETTO   NEOS   STUNT   SLIDER |
| 472465 | patte pot                     | TYPHOON   NRG   DNA   ICE   SR50 2005->   STALKER                           |

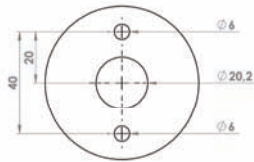

468160



465915



476255



472465

### tecnigas

#### PIÈCES DÉTACHÉES POT

|        |  |   |
|--------|--|---|
| 487984 | silencieux/cartouche                                       | Q-TRE   |
| 488094 | silencieux/cartouche alu 2 points de fixation noir         | NEXT R  |
| 493618 | silencieux/cartouche alu 2 points de fixation titane       | NEXT R  |
| 455006 | silencieux/cartouche alu 3 points de fixation noir         | NEXT R  |
| 494054 | silencieux/cartouche alu 3 points de fixation Ø40mm titane | NEXT R  |
| 494043 | silencieux/cartouche alu 3 points de fixation Ø40mm bleu   | NEXT R  |
| 440760 | collier silencieux Ø60mm                                   | NEXT   RS   MX                                      |
| 440761 | joint silencieux 2 points de fixation                      | BOOSTER   BW'S   NITRO   AEROX   TYPHOON   NRG   RU |

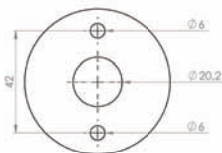

487984



493618

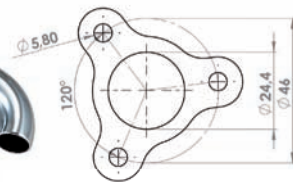

494054

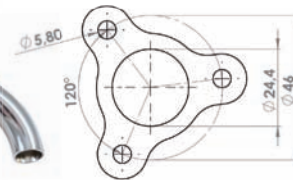

## ACCESSOIRE

Sélection  
**CGN**

## PIÈCES DÉTACHÉES POT

|        |                          |   |
|--------|--------------------------|---|
| 176744 | joint                    | BOOSTER   SR50   F12 fixation à bride                               |
| 173893 | joint rond 26.2x32.6x4.6 | BOOSTER   SR50   F12  |
| 467230 | joint rond 27.3x34.7x3.7 | LUDIX   VIVACITY 3   SPEEDFIGHT 3   KISBEE 2T   DJANGO AIR          |
| 440825 | joint renforcé           | pot à bride (fixation ouverte)                                      |
| 701    | joint 25.85x33.7x4.7     | SPEEDFIGHT   TREKKER   BUXY   VIVACITY   DAKOTA                     |
| 467231 | joint bride              | LUDIX   VIVACITY 3   SPEEDFIGHT 3   KISBEE 2T   DJANGO air          |
| 485884 | joint 3 trous            | KEEWAY   CPI  |
| 462487 | vis 6x18mm x10           | BOOSTER   BW'S   NITRO   OVETTO                                     |
| 483401 | goujon                   | LUDIX   VIVACITY   TREKKER   TYPHOON   STALKER   ZIP   FLY   RUNNER |



176744



173893



467230



440825



701



467231



485884



462487



483401

**DOPPLER**

## POT GP8.0 PASSAGE BAS DROIT

|        |                                  |
|--------|----------------------------------|
| 487598 | DERBI GPR   SENDA   RS4          |
| 487597 | X-POWER   MRT   BETA (AM6)   XPS |

**DOPPLER**

## POT GP8.0 PASSAGE HAUT GAUCHE

|        |   |
|--------|---|
| 487600 | DERBI SENDA   RX 2006->   SMT   RCR   SX 2006-> |
| 487599 | RIEJU RR   MRT   BETA RR 2012-> (AM6)           |





**DOPPLER**

## POT WR7 VERNI PASSAGE BAS

|        |                                   |
|--------|-----------------------------------|
| 479679 | APRILIA RS50 ->1999 Ø25/28        |
| 479485 | APRILIA RS50 1999->2005 Ø25/28    |
| 479480 | DERBI GPR 50 ->2002   GILERA GP50 |
| 479678 | X-POWER   TZR Ø25/28              |
| 479483 | XPS   XP6   X LIMIT 2003-> Ø25/28 |
| 479484 | XR6 Ø25/28                        |



**DOPPLER**

## POT WR7 VERNI PASSAGE HAUT GAUCHE

|        |   |
|--------|---|
| 479481 | DERBI SENDA tout modèle sauf DRD PRO cadre périmétrique |
| 480753 | RIEJU   SPIKE 1998->2002 Ø25/28                         |
| 479482 | XP6 ->2005 Ø25/28 cadre tubulaire carré                 |
| 479486 | XPSØ25/28   |



**LeoVince**

## POT X-FIGHT PASSAGE BAS

|                             | Silencieux alu | Silencieux noir |
|-----------------------------|----------------|-----------------|
| APRILIA RS4   GPR 2011 ->   | 484281         | 495795          |
| X POWER   TZR 50 2003-> Ø25 | 484600         |                 |



484281



495795



LeoVince

# ECHAPPEMENT / EXHAUST

## POT X-FIGHT PASSAGE HAUT

|   | Passage     | Silencieux alu | Silencieux noir |
|---|-------------|----------------|-----------------|
| BETA RR50 SUPERMOT   ENDURO 2012-> (AM6 Ø25)  | haut droit  | <b>483813</b>  | <b>495792</b>   |
| DERBI SENDA DRD PRO                           | haut droit  | <b>484283</b>  |                 |
| DERBI SENDA SM 2001->   GILERA SMT EURO 2   3 | haut gauche | <b>484282</b>  | <b>495793</b>   |
| HONDA HM CRE 50 (Ø 28) 2006->                 | haut gauche | <b>484599</b>  |                 |
| MBK X-LIMIT   YAMAHA DT50 2003->2012          | haut gauche | <b>484284</b>  |                 |
| RIEJU MRT   PRO   SM   SM PRO 2009->          | haut droit  | <b>484285</b>  | <b>495794</b>   |
| RX50   SX50 2006-> cadre périmétrique         | haut gauche | <b>484594</b>  |                 |



484283



495792

## YASUNI

### POT CROSS

|                                   | Passage     | Couleur silencieux |
|-----------------------------------|-------------|--------------------|
| <b>475361</b> SUZUKI RMX   SMX    | haut gauche | argent             |
| <b>481251</b> SENDA R   SM 2000-> | haut gauche | argent             |

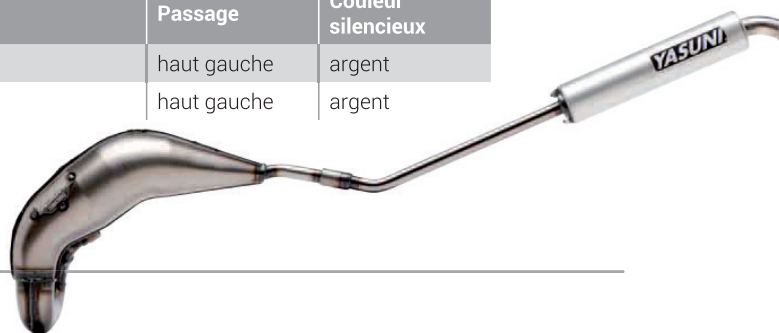

## YASUNI

### POT CROSS ML

|  | Passage     | Couleur silencieux |
|--|-------------|--------------------|
| <b>481252</b> XP6   MRX   SMX   BETA RR   SENDA SM   DRD   XTREM             | haut gauche | kevlar             |
| <b>472463</b> XP6   RIEJU RR   MRX   SMX   BETA   SENDA   DRD   XTREM   DT50 | haut gauche | argent             |





## YASUNI

### POT R1

|        |                                     | Passage | Couleur silencieux |
|--------|-------------------------------------|---------|--------------------|
| 472456 | RS2   TZR   XPOWER Ø25mm            | bas     | argent             |
| 494457 | BETA   SMX   MRT   DT50   XP6 Ø25mm | bas     | argent             |

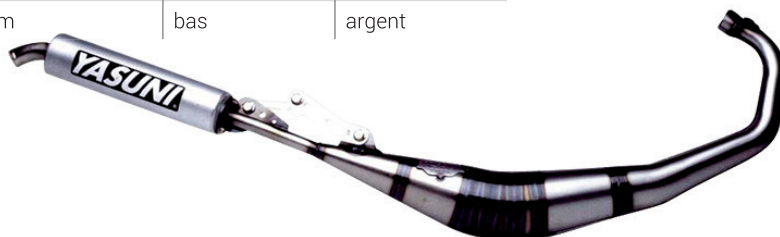

## YASUNI

### POT R2

|        |  | Passage | Couleur silencieux |
|--------|--|---------|--------------------|
| 481250 | RS50   RIEJU RS2   TZR   X POWER Ø28mm               | bas     | argent             |
| 473303 | RS50   RIEJU RS2   TZR   X POWER Ø28mm               | bas     | kevlar             |
| 481249 | DERBI   BETA   SMX   MRT   DT50   XP6   GPR Ø25/28mm | bas     | argent             |
| 478115 | DERBI   BETA   SMX   MRT   DT50   XP6   GPR Ø25/28mm | bas     | carbone            |
| 473304 | DERBI   BETA   SMX   MRT   DT50   XP6   GPR Ø25/28mm | bas     | siencieux kevlar   |



## YASUNI

### POT SPR3

|        |                        | Passage | Couleur silencieux |
|--------|------------------------|---------|--------------------|
| 472458 | DERBI                  | bas     | argent             |
| 472459 | AM6   RIEJU SPIKE   RR | bas     | argent             |

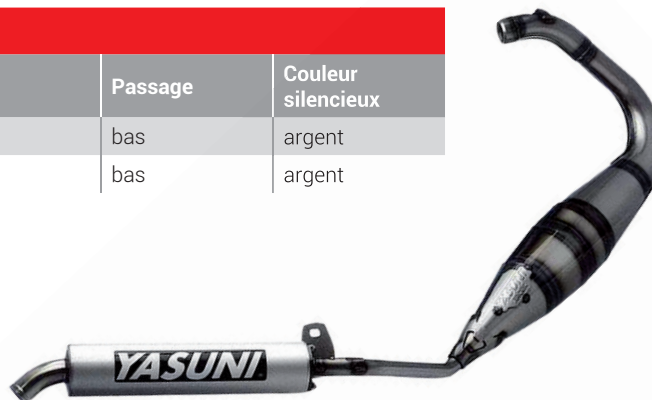



**YASUNI**

**POT CROSS HM**

|        |       | Passage | Couleur silencieux |
|--------|-------|---------|--------------------|
| 472462 | SENDA | haut    | argent             |
| 472464 | SENDA | haut    | kevlar             |



**BIDALOT**

**POT XMR CHROME**

|        |   | Passage     |
|--------|---|-------------|
| 465716 | SENDA   | haut gauche |
| 465717 | XPS   X-LIMIT DT50 2004-><br>cadre périmétrique | haut gauche |



**BIDALOT**

**POT XMR VERNI**

|        |  | Passage     |
|--------|--|-------------|
| 465714 | XPS   X- LIMIT   DT50 2004-><br>cadre périmétrique | haut gauche |
| 465713 | SENDA  | haut gauche |



**BIDALOT**

**POT SMR CHROME**

|        |                         | Passage |
|--------|-------------------------|---------|
| 467685 | RIEJU                   | bas     |
| 467681 | SENDA   SMT   RX 2006-> | bas     |



**BIDALOT**

**POT SMR VERNI**

|        |                     | Passage |
|--------|---------------------|---------|
| 467682 | X-LIMIT   XPS   XP6 | bas     |
| 494100 | RIEJU               | bas     |







**technigas**

## POT E-BOX PASSAGE BAS

|        |                                   |
|--------|-----------------------------------|
| 455004 | AM6 (RS3) SENDA tout modèle       |
| 478680 | DERBI GPR   APRILIA RS 2010->2011 |
| 450470 | RS50 2000->   TZR 50   X POWER    |
| 490806 | SHERCO 50 SM-R   50-R             |



**technigas**

## POT E-BOX PASSAGE HAUT

|        |  | Passage     |
|--------|--|-------------|
| 478566 | DERBI GPR NUDE   RACING 2004->2010   RS 2006->2010 | sous selle  |
| 491627 | SHERCO 50 SE-R   SM-R                              | haut droite |



**technigas**

## POT XS CHROME

|        |                                 | Passage |
|--------|---------------------------------|---------|
| 493795 | SENDA   SMT   RX   RCR 2006->   | bas     |
| 493796 | AM6   RIEJU MRT   MRX   BETA RR | bas     |



**technigas**

## POT E-NOX ACIER INOXYDABLE

|        |   | Passage     |
|--------|---|-------------|
| 460686 | SENDA 2000->   X-TREME   RACER   DRD   GILERA RCR             | haut gauche |
| 460687 | XP6 ->2005 cadre tubulaire carré Ø25/28mm                     | haut gauche |
| 461514 | XPS   X-LIMIT   DT50   XTM-XSM   HM CRE 50 cadre périmétrique | haut gauche |
| 483695 | CPI SM 50   | haut gauche |
| 477492 | RIEJU MRT   | haut droite |





**tecnigas**

**POT E-NOX ACIER**

|        |  | Passage     |
|--------|--|-------------|
| 489313 | SEDA 2000->   X-TREME   DRD   GILERA RCR | haut gauche |
| 489315 | X-LIMIT   DT50   XPS                     | haut gauche |
| 489314 | XP6   RIEJU RR   MRX                     | haut gauche |
| 489316 | RIEJU MRT                                | haut gauche |



**MALOSSI**

**POT MHR REPLICA**

|        |   | Passage     |
|--------|---|-------------|
| 483878 | SEDA DRD PRO                                    | haut droite |
| 461349 | SEDA  | haut gauche |
| 461344 | GPR 50 NUDE   RACING 2004->2010   RS 2006->2010 | sous selle  |



## ACCESSOIRE



### PIÈCES DÉTACHÉES POT

|        |   |                    |
|--------|---|--------------------|
| 437928 | bague échappement ER1   WR7   GP8.0 pour cylindre Ø28mm avec pot Ø25mm                  | AM6                |
| 449887 | collier silencieux ER1   WR7   GP8.0 + caoutchouc noir Ø70mm                            |                    |
| 497296 | collier silencieux ER1   WR7   GP8.0 + caoutchouc noir Ø70mm                            |                    |
| 483077 | joint silencieux WR7   ER1   GP8.0   CONTI   MALOSSI   TECNIGAS entre pot et silencieux |                    |
| 493953 | joint silencieux/cartouche ER1/ER2/GP8.0/WR7/LEOVINCE V6 universel                      |                    |
| 479810 | manchon ER1/WR7/GP8/ER2 machine à boîte compatible TECNIGAS et BIDALOT                  |                    |
| 488782 | rotule + visserie + pattes GP8.0  | AM6 passage bas    |
| 488784 | rotule + visserie + pattes GP8.0  | AM6 passage haut   |
| 488783 | rotule + visserie + pattes GP8.0  | DERBI passage bas  |
| 488785 | rotule + visserie + pattes GP8.0  | DERBI passage haut |
| 481734 | ressort pot x1  | long 70mm          |
| 481735 | ressort pot silencieux x1   | court 55mm         |
| 294376 | silencieux/cartouche alu poli ER1 3 fixations   |                    |
| 493846 | silencieux/cartouche ER1 noir montage universel Ø70mm                                   | 50 à boîte         |
| 490266 | silencieux/cartouche GP8.0 noir   |                    |
| 481194 | silencieux/cartouche WR7 titane   |                    |



437928



449887



497296



483077



493953



479810



488782



488784



488783



488785



294376



490266



493846

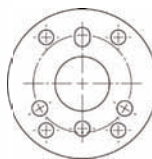

481194

ACCESSOIRE

LeoVince

PIÈCES DÉTACHÉES POT X-FIGHT

|        |                            |                                     |
|--------|----------------------------|-------------------------------------|
| 490355 | collier silencieux carbone | RS4   BETA   DERBI SENDA PRO        |
| 490357 | collier silencieux carbone | DERBI SENDA   HM   DT50   MRT   TZR |
| 490360 | silencieux/cartouche       | argent                              |
| 497366 | silencieux/cartouche       | noir                                |



490355



490357



490360



497366

YASUNI

PIÈCES DÉTACHÉES POT

|        |                              |                                |
|--------|------------------------------|--------------------------------|
| 481463 | collier silencieux pot Ø60mm |                                |
| 478456 | patte pot R2                 | DERBI   RIEJU SMX   DT50   XP6 |
| 493141 | bride pot R2                 |                                |
| 472821 | silencieux/cartouche argent  | 50cc                           |
| 482493 | silencieux/cartouche carbone | 50cc                           |
| 472822 | silencieux/cartouche kevlar  | 50cc                           |



481463



478456



472821

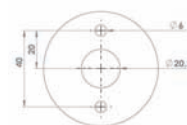

493141



482493



472822

## ACCESSOIRE

### BIDALOT

#### PIÈCES DÉTACHÉES POT SMR/MXR GUN

- 467693 silencieux/cartouche métal
- 479810 manchon caoutchouc



### tecnigas

#### PIÈCES DÉTACHÉES POT E-BOX/E-NOX

- 479809 silencieux/cartouche kevlar
- 484470 silencieux/cartouche titane
- 479808 silencieux/cartouche titane
- 479810 manchon caoutchouc



479809



484470



479808

### MALOSSI

#### PIÈCES DÉTACHÉES POT MHR

- 485497 silencieux/cartouche à emmancher
- 494134 silencieux/cartouche 3 trous



485497



494134

### TEKNIX

#### PIÈCES DÉTACHÉES POT

- 497121 joint AM6 sortie cylindre Ø25 (torique x1)
- 489254 joint AM6 sortie cylindre Ø28 (torique x1)
- 489831 joint 31mm extérieur 24mm intérieur



489254



489831



**DOPPLER**

**POT ERI**

| Modèle               | Silencieux carbone | Silencieux alu |
|----------------------|--------------------|----------------|
| 103 SPX   RCX        | <b>489625</b>      | <b>187107</b>  |
| 103 VOGUE   SP   MVL | <b>489626</b>      | <b>187092</b>  |
| MBK 51               | <b>489627</b>      | <b>187111</b>  |



489625



187107

**DOPPLER**

**POT ERI CHROMÉ**

|               |                      |
|---------------|----------------------|
| <b>493895</b> | 103 SPX   RCX        |
| <b>493896</b> | 103 VOGUE   SP   MVL |
| <b>493897</b> | MBK 51               |



**SITO POT**



**460658**

DAKOTA | PHENIX fixation à bride



**1438**

103 pot COBRA fixation à bride



**214526**

FOX | FXR fixation à bride



**4161**

MBK 51 pot COBRA fixation à visser

# ECHAPPEMENT / EXHAUST

MOTEUR



**TEKNIX**  
Original Quality Controller

**POT TYPE ORIGINE**



**1433**  
102



**1435**  
103 fixation à bride



**1434**  
103 fixation à visser



**1436**  
103 VOGUE | MVL M



**3280**  
CIAO PX



**4160**  
MBK 40 | 50 | 88 | 89 AV7 chrome



**4159**  
MBK 51 noir

**tecnigas**

**POT NEXT R**

455205 FOX | FXR | WALLAROO

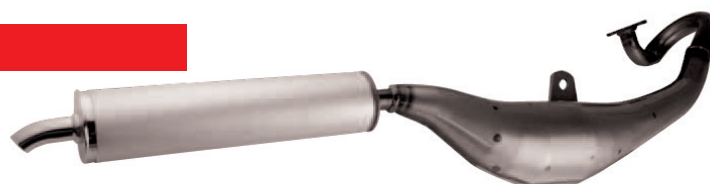

**ACCESSOIRE**

**DOPPLER PIÈCES DÉTACHÉES POT**

|   |   |   |   |
|---|---|---|---|
|   |   |   |   |
| <p><b>195250</b><br/>silencieux   cartouche ER1 alu<br/>103 SP   51 MBK   MVL   VOGUE  <br/>SPX   RCX</p> | <p><b>195279</b><br/>bielle + rotule + visserie ER1<br/>103 SP   MVL   VOGUE</p>      | <p><b>195264</b><br/>bielle + rotule + visserie ER1<br/>103 SPX   RCX</p> | <p><b>214537</b><br/>bielle + rotule + visserie ER1<br/>bras carré MBK 51</p> |
|   |   |   |   |
| <p><b>450360</b><br/>joint silencieux   cartouche S3R   ER1   NINJA<br/>  GIANNELLI</p>                   | <p><b>195298</b><br/>rotule ER1 avec ressort 103 SP   MVL  <br/>VOGUE   RCX   SPX</p> | <p><b>195283</b><br/>rotule ER1 MBK 51</p>                                |   |

**Sélection CGN PIÈCES DÉTACHÉES POT**

|   |  |   |
|---|--|---|
|   |  |   |
| <p><b>1733</b><br/>adaptateur pot bridé femelle pour cylindre<br/>bridé 103</p> | <p><b>763</b><br/>collier 103</p>  | <p><b>4168</b><br/>collier ovale MBK 51</p>                                 |
|   |  |   |
| <p><b>486013</b><br/>collier MBK 40   50   88</p>                               | <p><b>490337</b><br/>collier (demi collier partie inférieure) MBK 51</p> | <p><b>486430</b><br/>écrou carré cylindre pot bridé M6x100 103<br/>(x1)</p> |
|   |  |   |
| <p><b>764</b><br/>joint pot cyclo 22.80x29.9x3.86mm cuivre<br/>103   51 MBK</p> | <p><b>766</b><br/>joint pot (bridé) 103</p>                              | <p><b>1443</b><br/>récupérateur cylindre 103   51 MBK</p>                   |



## ACCESSOIRE



### PIÈCES DÉTACHÉES POT

|        |                      |    |
|--------|----------------------|----|
| 1743   | ressort Ø10 1.8x55mm | x1 |
| 1744   | ressort Ø10 2.0x61mm | x1 |
| 472641 | ressort Ø10 1.6x55mm | x1 |
| 472602 | ressort Ø10 1.6x60mm | x1 |
| 481734 | long 70mm            | x1 |
| 481735 | long 55mm            | x1 |



1743



1744



472641



472602

### Laine silencieux résistante très haute température (sachet)

484856 500x700x10mm

484855 300x300x10mm

### Laine silencieux céramique (sachet)

1646 300x250x13mm céramique fabrication française

480789 300x300x7mm céramique

479171 300x600x11mm céramique avec paille de fer

483726 500x700x13mm fibre de verre fabrication française

### Bande thermique fibre de verre échappement blanc

496875 rouleau de 1m largeur 50mm



484855



480789



496875

## DIMENSIONS ET GRAMMAGES DES GALETS D'ORIGINE SCOOTER 50CC

|                                   | Dimensions | Grammages |
|-----------------------------------|------------|-----------|
| <b>APPRILIA</b>                   |            |           |
| RALLY (MINARELLI)                 | 15x12      | 6.5       |
| SR (PIAGGIO)                      | 19x15.5    | 7.5       |
| SR (MINARELLI)                    | 15x2       | 5.5       |
| <b>BENELLI</b>                    |            |           |
| 491 (MINARELLI)                   | 15x12      | 6.5       |
| 491 (MORINI)                      | 17x12.3    | 5.3       |
| <b>CPI</b>                        |            |           |
| ARAGON                            | 15x12      | 6         |
| HUSSAR                            | 15x12      | 6         |
| OLIVER                            | 15x12      | 6         |
| POPCORN                           | 15x12      | 6         |
| <b>DERBI</b>                      |            |           |
| ATLANTIC                          | 19x15.5    | 6.5       |
| ATLANTIC (MORINI)                 | 17x12.3    | 7         |
| GP1                               | 19x15.5    | 6.5       |
| <b>GILERA</b>                     |            |           |
| DNA                               | 19x15.5    | 7.5       |
| ICE                               | 19x15.5    | 7.5       |
| RUNNER PUR JET ->2005   SP 2006-> | 19x15.5    | 6.5       |
| RUNNER PUR JET 2006->             | 19x15.5    | 5.5       |
| RUNNER SP ->2005                  | 19x15.5    | 7.5       |
| STALKER                           | 19x15.5    | 7.5       |
| <b>HONDA</b>                      |            |           |
| BALI                              | 16x13      | 8.5       |
| DIO                               | 16x13      | 8.5       |
| SH 1996->                         | 16x13      | 9         |
| SHADOW                            | 16x13      | 8.5       |
| VISION                            | 16x13      | 8.5       |
| X8R                               | 16x13      | 8.5       |
| ZOOMER                            | 16x13      | 6         |
| <b>KEEWAY</b>                     |            |           |
| F-ACT   RY8                       | 15x12      | 6         |
| GOCCIA                            | 15x12      | 4.8       |
| HURRICANE                         | 15x12      | 4.8       |
| MATRIX                            | 15x12      | 4.8       |
| PIXEL                             | 15x12      | 4.8       |
| <b>KYMCO</b>                      |            |           |
| AGILITY R10/12/16 4 temps EURO2   | 16x13      | 6         |
| DINK 2 temps                      | 16x13      | 8.5       |
| DINK 4 temps                      | 16x13      | 6         |
| SUPER 8                           | 16x13      | 6         |

|  | Dimensions | Grammages |
|--|------------|-----------|
| <b>MALAGUTI</b>                          |            |           |
| F12 (MINARELLI)                          | 15x2       | 6.5       |
| <b>MBK   YAMAHA</b>                      |            |           |
| BOOSTER   NG   ROCKET   STUNT (catalysé) | 15x12      | 5.4       |
| BOOSTER (non catalysé)                   | 15x12      | 6.5       |
| MACH G air (catalysé)                    | 15x12      | 6.5       |
| MACH G liquide                           | 15x12      | 5.4       |
| NITRO (catalysé)                         | 15x12      | 6.5       |
| NITRO liquide                            | 15x12      | 5.4       |
| OVETTO (catalysé)                        | 15x12      | 6.5       |
| OVETTO   NITRO 4 temps                   | 15x12      | 4.8       |
| STUNT (non catalysé)                     | 15x12      | 6.5       |
| <b>PEUGEOT</b>                           |            |           |
| BUXY                                     | 16x13      | 8.5       |
| DJANGO 2 temps                           | 16x13      | 8.9       |
| DJANGO 4 temps                           | 16x13      | 5.6       |
| ELYSEO 2 temps                           | 16x13      | 9         |
| KISBEE 2 temps                           | 16x13      | 8.9       |
| KISBEE 4 temps                           | 16x13      | 5.6       |
| LUDIX 2 temps                            | 16x13      | 8.9       |
| LUDIX BLASTER 2 temps                    | 16x13      | 8         |
| LUDIX ONE                                | 16x13      | 9         |
| METAL X 2 temps                          | 16x13      | 9         |
| SPEEDAKE                                 | 16x13      | 8.5       |
| SPEEDFIGHT 1 et 3                        | 16x13      | 9         |
| SPEEDFIGHT 2, 2 temps                    | 16x13      | 8         |
| SPEEDFIGHT 3, 2 temps                    | 16x13      | 8.9       |
| SQUAB                                    | 16x13      | 9         |
| SV                                       | 16x13      | 8.5       |
| TREKER                                   | 16x13      | 8.5       |
| TWEET                                    | 16x13      | 6         |
| V CLIC                                   | 16x13      | 5.6       |
| VIVACITY ->2008                          | 16x13      | 8.5       |
| VIVACITY 2008-> 2 temps                  | 16x13      | 8         |
| VIVACITY 3 4 temps                       | 16x13      | 6         |
| VIVACITY 3, 2 temps                      | 16x13      | 8.9       |
| ZENITH                                   | 16x13      | 8.5       |

## DIMENSIONS ET GRAMMAGES DES GALETS D'ORIGINE SCOOTER 50CC

|                        | Dimensions | Grammages |
|------------------------|------------|-----------|
| <b>PIAGGIO   VESPA</b> |            |           |
| ET2 2000               | 19x15.5    | 7.5       |
| ET4                    | 19x15.5    | 6.5       |
| FLY 2 temps            | 19x15.5    | 7.5       |
| FLY 4 temps            | 19x15.5    | 6.5       |
| LIBERTY 2 et 4 temps   | 19x15.5    | 6.5       |
| MC3 PURJET DD EXTREME  | 19x15.5    | 7.5       |
| NRG                    | 16x13      | 8.5       |
| NRG MC2                | 16x13      | 7         |
| NRG MC2 1999->         | 19x15.5    | 7.5       |
| NRG POWER DT 4 temps   | 19x15.5    | 6.5       |
| NRG POWER PUREJET      | 19x15.5    | 5.5       |
| TYPHOON ->1999         | 16x13      | 8.5       |
| TYPHOON 1999->2007     | 19x15.5    | 7.5       |
| TYPHOON 2007->         | 19x15.5    | 7.5       |
| ZIP 2001->             | 19x15.5    | 7.5       |
| ZIP 4 temps            | 19x15.5    | 6.5       |
| ZIP FAST RIDER         | 16x13      | 8.5       |
| ZIP SP liquide ->2000  | 16x13      | 7         |
| <b>SUZUKI</b>          |            |           |
| ADDRESS                | 17x12.3    | 6.5       |
| KATANA                 | 17x12.3    | 6.5       |
| <b>SYM</b>             |            |           |
| DD                     | 16x13      | 8.5       |
| JET                    | 16x13      | 8.5       |
| MIO                    | 16x13      | 5.9       |
| SYMPHONY               | 16x13      | 5.9       |
| SYMPPLY                | 16x13      | 5.9       |

## DIMENSIONS ET GRAMMAGES DES GALETS D'ORIGINE MAXI SCOOTER

|                                   | Dimensions | Grammages |
|-----------------------------------|------------|-----------|
| <b>APRILIA   GILERA   PIAGGIO</b> |            |           |
| BEVERLY 125/200                   | 19x17      | 7.4       |
| DNA 125 4 temps                   | 19x17      | 10        |
| FLY 125 4 temps                   | 19x17      | 8.7       |
| HEXAGON 125                       | 19x17      | 12        |
| LEONARDO 125                      | 20x17      | 8.5       |
| LIBERTY ->1999 125                | 19x13.7    | 12        |
| LIBERTY 125                       | 19x17      | 8.7       |
| MP3 125                           | 19x17      | 8.7       |
| SCARABEO 125                      | 19x17      | 7.4       |
| SCARABEO 125 (ROTAX)              | 20x17      | 8.5       |
| SKIPPER 125                       | 19x17      | 12        |
| SR 125                            | 19x17      | 12        |
| SUPER HEXAGON 125                 | 19x17      | 7.4       |
| TYPHOON 125 2 temps               | 19x17      | 8.7       |
| TYPHOON 125 4 temps               | 19x17      | 12        |
| X7 125                            | 19x17      | 7.4       |
| X8 125                            | 19x17      | 7.4       |
| X9 125                            | 19x17      | 7.4       |
| ZIP 125                           | 19x17      | 8.7       |
| <b>HONDA</b>                      |            |           |
| DYLAN 125 (injection)             | 20x14.6    | 11.5      |
| DYLAN 150                         | 20x14.6    | 12.5      |
| PANTHEON 125                      | 20x14.6    | 12.3      |
| PANTHEON 125 (injection)          | 20x14.6    | 11.5      |
| PANTHEON 150 2 temps              | 23x18      | 17        |
| PANTHEON 150 4 temps              | 20x14.6    | 12.5      |
| PCX 125                           | 20x14.6    | 14.5      |
| PS 125 (injection)                | 20x14.6    | 11.5      |
| SH 125 (injection)                | 20x14.6    | 11.5      |
| SH 125 (injection)                | 20x14.6    | 10.5      |
| <b>KYMCO</b>                      |            |           |
| AGILITY 125                       | 18x14      | 13        |
| AGILITY 125 RS/150                | 20x14.6    | 15.5      |
| BET & WIN 125/150                 | 20x14.6    | 15.5      |
| DINK 125                          | 20x14.6    | 15.5      |
| GRAND DINK 125                    | 20x14.5    | 12.5      |
| GRAND DINK 250                    | 23x18      | 20        |
| PEOPLE 125                        | 18x14      | 13        |
| PEOPLE 150/200                    | 20x14.6    | 15.5      |
| PEOPLE 250                        | 23x18      | 20        |
| SUPER 8 125                       | 18x14      | 13        |

# VARIATION / VARIATION

## DIMENSIONS ET GRAMMAGES DES GALETS D'ORIGINE MAXI SCOOTER

|                             | Dimensions | Grammages |
|-----------------------------|------------|-----------|
| <b>MALAGUTI</b>             |            |           |
| MADISON 125 (YAMAHA)        | 20x12      | 10        |
| <b>MBK   YAMAHA</b>         |            |           |
| CYGNUS 125 INJECTION        | 20x12      | 9         |
| GYGNUS 125                  | 20x12      | 10        |
| MAJESTY 125                 | 20x12      | 9         |
| T MAX 500 2001->2003        | 24x14.9    | 20        |
| T MAX 500 2003->            | 24x14.9    | 18        |
| T MAX 530                   | 24x14.9    | 17        |
| X CITY 125                  | 20x12      | 10        |
| X CITY 250                  | 20x12      | 12        |
| X MAX 125                   | 20x12      | 10        |
| X MAX 250                   | 20x12      | 12        |
| <b>PEUGEOT</b>              |            |           |
| ELYSEO 125                  | 20x12      | 12        |
| ELYSTAR 125                 | 20x12      | 12.3      |
| GEPOLIS 125                 | 20x17      | 9.5       |
| GEPOLIS 250                 | 20.9x17    | 11        |
| JET FORCE 125               | 20x17      | 9.5       |
| JET FORCE 125 (COMPRESSORT) | 20.9x17    | 11        |
| SATELIS 125                 | 20x17      | 9.5       |
| SATELIS 125 (COMPRESSORT)   | 20.9x17    | 11        |
| TWEET 125                   | 18x14      | 10        |

|                                   | Dimensions | Grammages |
|-----------------------------------|------------|-----------|
| <b>SUZUKI</b>                     |            |           |
| BRUGMAN 125                       | 20x15      | 12.9      |
| BURGMAN 150                       | 20x15      | 16.8      |
| BURGMAN 250                       | 23.8x18    | 23        |
| <b>SYM</b>                        |            |           |
| EURO MX 125                       | 18x14      | 10        |
| FIDDLE 125 EURO3                  | 18x14      | 14        |
| GTS 125                           | 18x14      | 10        |
| SYMPHONY 125                      | 18x14      | 10        |
| <b>VESPA</b>                      |            |           |
| ET4 125 (LEADER)                  | 19x13.7    | 12        |
| ET4 125 (LEADER)                  | 19x17      | 8.7       |
| ET4 125 (LEADER)                  | 19x17      | 10        |
| GRANTURISMO L GT 200              | 20x17      | 12.5      |
| GRANTURISMO L GT GTV 125 (LEADER) | 19x17      | 7.4       |
| GTS 125 (injection)               | 19x17      | 7.4       |
| LX 125 (LEADER)                   | 19x13.7    | 12        |
| LX 125 (LEADER)                   | 19x17      | 8.7       |
| LX 150 (LEADER)                   | 19x17      | 10        |



### GALET

|                    | DOPPLER      |  |  |                |                                   | MAXI-SCOOTER           |  |  |                              |              |
|--------------------|--------------|--|--|----------------|-----------------------------------|------------------------|--|--|------------------------------|--------------|
|                    | MBK   YAMAHA | DOPPLER (S1 BOOSTER   SR   F10   F12   TYPHOON   ER2   103 Sp-MVL) | DOPPLER (S1 BUXY   ER1 103 SPX-RCX et 51) HONDA   KYMCO   PEUGEOT   PGO   PIAGGIO ->1999 | DERBI   SUZUKI | GILERA   PIAGGIO nouveaux modèles | KYMCO   MALAGUTI   SYM | APRILIA   BENELLI   DERBI   GILERA   ITALJET   PIAGGIO   VESPA | APRILIA   BENELLI   ITALJET   MLAGUTI   MBK   PEUGEOT   YAMAHA | APRIALIA   PEUGEOT   PIAGGIO | YAMAHA       |
| Poids / Dimensions | 15x12 (x6)   | 15x13 (x6)   | 16x13 (x6)   | 17x12 (x6)     | 19x15.5 (x6)                      | 18x14 (x6)             | 19x17 (x6)   | 20x12 (x6)   | 20x17 (x6)                   | 25x14.9 (x8) |
| 2.1g               | 326175       |  | 326290   |                |                                   |                        |  |  |                              |              |
| 2.5g               | 325092       |  | 325327   |                |                                   |                        |  |  |                              |              |
| 2.7g               | 325107       |  | 291195   |                |                                   |                        |  |  |                              |              |
| 2.9g               |              |  |  |                | 325619                            |                        |  |  |                              |              |
| 3.0g               | 291286       | 290377   | 290199   | 325403         | 325642                            |                        |  |  |                              |              |
| 3.2g               |              |  | 326304   |                |                                   |                        |  |  |                              |              |
| 3.3g               | 291248       | 325198   | 325331   |                |                                   |                        |  |  |                              |              |
| 3.5g               | 291252       |  | 290203   |                | 325661                            |                        |  |  |                              |              |
| 3.6g               |              |  | 326319   | 326400         |                                   |                        |  |  |                              |              |
| 3.7g               | 325111       |  | 291200   |                | 325676                            |                        |  |  |                              |              |
| 4.0g               | 291297       | 290390   | 326620   | 325441         | 325687                            |                        |  |  |                              |              |
| 4.2g               | 326194       |  | 290218   |                |                                   |                        |  |  |                              |              |

# VARIATION / VARIATION

**DOPPLER**

**GALET**

**MAXI-SCOOTER**

|                       | MBK  <br>YAMAHA | DOPPLER<br>(S1<br>BOOSTER<br>  SR   F10<br>  F12  <br>TYPHOON<br>  ER2   103<br>Sp-MVL) | DOPPLER<br>(S1 BUXY<br>  ER1 103<br>SPX-RCX et<br>51) HONDA<br>  KYMCO  <br>PEUGEOT<br>  PGO  <br>PIAGGIO<br>->1999 | DERBI  <br>SUZUKI | GILERA  <br>PIAGGIO<br>nouveaux<br>modèles | KYMCO  <br>MALAGUTI<br>  SYM | APRILIA  <br>BENELLI<br>  DERBI  <br>GILERA  <br>ITALJET  <br>PIAGGIO  <br>VESPA | APRILIA  <br>BENELLI  <br>ITALJET  <br>MLAGUTI<br>  MBK  <br>PEUGEOT  <br>YAMAHA | APRILIA  <br>PEUGEOT  <br>PIAGGIO | YAMAHA          |
|-----------------------|-----------------|---|---|-------------------|--|------------------------------|--|--|-----------------------------------|-----------------|
| Poids /<br>Dimensions | 15x12<br>(x6)   | 15x13<br>(x6)   | 16x13<br>(x6)   | 17x12<br>(x6)     | 19x15.5<br>(x6)                            | 18x14<br>(x6)                | 19x17<br>(x6)  | 20x12<br>(x6)  | 20x17<br>(x6)                     | 25x14.9<br>(x8) |
| 4.3g                  | 291267          | 325217  | 291305  |                   | 325695                                     |                              |  |  |                                   |                 |
| 4.4g                  |                 |   |   | 325384            |  |                              |  |  |                                   |                 |
| 4.5g                  | 291434          | 290404  | 290222  |                   |  |                              |  |  |                                   |                 |
| 4.7g                  | 291343          | 325221  | 291214  |                   | 325714                                     |                              |  |  |                                   |                 |
| 4.8g                  | 326209          |   |   |                   |  |                              |  |  |                                   |                 |
| 5.0g                  | 291358          | 290419  | 290237  | 325480            | 325729                                     |                              |  |  |                                   |                 |
| 5.1g                  | 326607          |   | 326338  |                   |  |                              |  |  |                                   |                 |
| 5.3g                  | 291362          | 325236  | 291229  |                   | 325733                                     |                              |  |  |                                   |                 |
| 5.5g                  | 325126          | 290275  | 291233  | 325509            | 325748                                     |                              |  |  |                                   |                 |
| 5.7g                  | 291377          | 325247  | 291310  |                   | 325752                                     |                              |  |  |                                   |                 |
| 5.8g                  | 326213          |   |   |                   |  |                              |  |  |                                   |                 |
| 6.0g                  | 291487          | 290280  | 290241  | 325528            | 325767                                     |                              | 483244   |  |                                   |                 |
| 6.3g                  | 291381          |   | 291324  |                   | 325771                                     |                              |  |  |                                   |                 |
| 6.4g                  |                 |   |   |                   |  | 436481                       |  |  |                                   |                 |
| 6.5g                  | 325137          |   | 325346  | 325547            | 325786                                     |                              | 483245   |  |                                   |                 |
| 6.7g                  | 325145          | 325274  | 291339  | 325513            |  |                              |  |  |                                   |                 |
| 6.8g                  |                 |   |   |                   | 326497                                     |                              |  |  |                                   |                 |
| 7.0g                  | 291396          |   | 290256  | 325566            | 325805                                     |                              | 483246   | 483253   | 483262                            |                 |
| 7.2g                  | 326232          |   |   | 325551            | 326505                                     |                              |  |  |                                   |                 |
| 7.5g                  | 325150          |   | 325357  |                   | 325810                                     | 436625                       | 483247   | 483254   |                                   |                 |
| 7.8g                  |                 |   | 326361  |                   | 325824                                     |                              |  |  |                                   |                 |
| 8.0g                  | 291453          | 290309  | 290267  |                   |  |                              | 483248   | 483255   | 483263                            |                 |
| 8.2g                  |                 |   |   |                   | 326510                                     |                              |  |  |                                   |                 |
| 8.4g                  |                 |   |   |                   | 326539                                     |                              |  |  |                                   |                 |
| 8.5g                  | 291407          |   | 325365  |                   |  | 483236                       | 483249   | 483256   | 483264                            |                 |
| 8.7g                  |                 |   |   |                   | 325839                                     |                              | 484133   |  |                                   |                 |
| 9.0g                  | 291472          |   | 291449  |                   |  | 483238                       | 483250   | 483257   | 483266                            |                 |
| 9.4g                  |                 |   |   |                   | 325843                                     |                              |  |  |                                   |                 |
| 9.5g                  |                 |   | 326668  |                   |  |                              | 483251   | 483258   | 483265                            |                 |
| 9.9g                  |                 |   | 326376  |                   |  |                              |  |  |                                   |                 |
| 10.0g                 |                 |   |   |                   | 326543                                     | 483239                       | 483252   | 483259   | 483267                            |                 |
| 10.5g                 |                 |   |   |                   |  | 483240                       |  | 483260   | 483268                            |                 |
| 11.0g                 |                 |   |   |                   |  | 483241                       |  | 483261   | 483269                            |                 |
| 11.5g                 |                 |   |   |                   | 326562                                     | 483242                       |  |  |                                   |                 |
| 12.0g                 |                 |   |   |                   |  | 483243                       |  |  | 483271                            |                 |
| 14.0g                 |                 |   |   |                   |  |                              |  |  | 483270                            | 483273          |
| 15.0g                 |                 |   |   |                   |  |                              |  |  |                                   | 483274          |
| 16.0g                 |                 |   |   |                   |  |                              |  |  |                                   | 483275          |
| 17.0g                 |                 |   |   |                   |  |                              |  |  |                                   | 483276          |
| 18.0g                 |                 |   |   |                   |  |                              |  |  |                                   | 483277          |

**MOTEUR**

**GALET CERAMID**



|                       | APRILIA   BETA   CAGIVA  <br>ITALJET   MALAGUTI   MBK<br>  YAMAHA | DOPPLER (S1 BOOSTER  <br>SR   F10   F12   TYPHOON  <br>ER2   103 Sp-MVL) |
|-----------------------|---|--|
| Poids /<br>Dimensions | 15x12 (x6)  | 15x13 (x6)   |
| 4.0g                  | 466098  |  |
| 4.5g                  | 466099  |  |
| 7.0g                  | 466104  |  |
| 7.5g                  | 466105  |  |
| 9.0g                  |   | 466124   |
| 7.0g                  |   | 466120   |



**BOÎTE ATELIER GALET**

|        |         |                  |         |
|--------|---------|------------------|---------|
| 493726 | 15x12   | MBK   YAMAHA     | 45 jeux |
| 493727 | 19x15.5 | GILERA   PIAGGIO | 24 jeux |
| 493728 | 16x13   | PEUGEOT/PIAGGIO  | 35 jeux |



493726



493727



493728



## GALET CERAMID

| Poids / Dimensions | MAXI-SCOOTER |   |                |                                   |  |   |                        |              |                             |              |                             |
|--------------------|--------------|---|----------------|-----------------------------------|--|---|------------------------|--------------|-----------------------------|--------------|-----------------------------|
|                    | MBK   YAMAHA | DOPPLER (S1 BUXY   ER1 103 SPX-RCX et 51)   HONDA   KYMCO   PEUGEOT   PGO   PIAGGIO | DERBI   SUZUKI | GILERA   PIAGGIO nouveaux modèles | APRILIA   BENELLI   DERBI   GILERA   ITALJET   PIAGGIO   VESPA | APRILIA   BENELLI   ITALJET   MALAGUTI   MBK   PEUGEOT   YAMAHA | KYMCO   MALAGUTI   SYM | HONDA        | APRILIA   PEUGEOT   PIAGGIO | YAMAHA       | APRILIA   PEUGEOT   PIAGGIO |
|                    | 15x12 (x6)   | 16x13 (x6)  | 17x12.3 (x6)   | 19x15.5 (x6)                      | 19x17 (x6)   | 20x12 (x6)  | 18x14 (x6)             | 20x14.6 (x6) | 20x17 (x6)                  | 25x14.9 (x8) | 25x17 (x8)                  |
| 2.3g               |              | 490541  |                |                                   |  |   |                        |              |                             |              |                             |
| 2.9g               |              |   |                | 365967                            |  |   |                        |              |                             |              |                             |
| 3.2g               | 461330       |   |                |                                   |  |   |                        |              |                             |              |                             |
| 3.5g               | 461331       |   |                |                                   |  |   |                        |              |                             |              |                             |
| 3.7g               | 461332       |   |                |                                   |  |   |                        |              |                             |              |                             |
| 4.2g               | 461333       |   |                |                                   |  |   |                        |              |                             |              |                             |
| 4.3g               |              |   |                | 265597                            |  |   |                        |              |                             |              |                             |
| 4.5g               |              |   | 490533         |                                   |  |   |                        |              |                             |              |                             |
| 4.7g               |              | 1992  |                | 265605                            |  |   |                        |              |                             |              |                             |
| 4.8g               | 461334       |   |                |                                   |  |   |                        |              |                             |              |                             |
| 5.0g               |              |   | 490531         | 265610                            |  |   |                        |              |                             |              |                             |
| 5.1g               |              | 290624  |                |                                   |  |   |                        |              |                             |              |                             |
| 5.4g               | 461335       |   |                |                                   |  |   |                        |              |                             |              |                             |
| 5.5g               |              |   | 490532         | 265639                            |  |   |                        |              |                             |              |                             |
| 5.7g               |              |   |                | 265643                            |  |   |                        |              |                             |              |                             |
| 6.0g               | 461336       | 290639  | 490529         |                                   |  |   |                        |              |                             |              |                             |
| 6.5g               | 461337       |   | 490534         | 290658                            |  |   |                        |              |                             |              |                             |
| 6.8g               | 461338       |   |                |                                   |  |   |                        |              |                             |              |                             |
| 7.0g               |              | 194867  | 490535         |                                   |  |   |                        |              |                             |              |                             |
| 7.2g               | 461339       |   |                |                                   |  |   |                        |              |                             |              |                             |
| 7.8g               | 490530       |   |                |                                   |  |   |                        |              |                             |              |                             |
| 8.0g               |              | 194875  |                |                                   |  | 473339  |                        |              | 476500                      |              |                             |
| 8.5g               |              | 468745  |                |                                   |  | 472121  |                        |              | 461369                      |              |                             |
| 8.7g               | 490537       |   |                |                                   | 478037   |   |                        |              |                             |              |                             |
| 9.0g               |              |   |                |                                   |  | 478038  |                        |              | 472119                      |              |                             |
| 9.5g               |              |   |                |                                   |  |   |                        |              | 472120                      |              |                             |
| 10.0g              |              |   |                |                                   |  |   | 482248                 |              |                             |              |                             |
| 10.5g              |              |   |                |                                   |  |   |                        | 487021       |                             |              |                             |
| 11.0g              |              |   |                |                                   |  | 478040  |                        |              |                             |              |                             |
| 11.5g              |              |   |                |                                   |  |   |                        |              | 472445                      |              |                             |
| 12.5g              |              |   |                |                                   |  |   |                        | 487020       |                             |              |                             |
| 13;0g              |              |   |                |                                   |  |   | 482247                 |              |                             |              |                             |
| 14.0g              |              |   |                |                                   |  |   |                        |              |                             | 477226       |                             |
| 14.5g              |              |   |                |                                   |  |   |                        | 487019       |                             |              |                             |
| 15.0g              |              |   |                |                                   |  |   |                        |              |                             |              | 477227                      |
| 16.0g              |              |   |                |                                   |  |   |                        |              |                             | 478041       | 487022                      |

**MALOSSI GALET**

VARIATION / VARIATION

|                       | MBK   YAMAHA | HONDA   KYMCO  <br>PEUGEOT   PGO   PIAGGIO | GILERA   PIAGGIO nouveaux<br>modèles |
|-----------------------|--------------|--|--------------------------------------|
| Poids /<br>Dimensions | 15x12 (x6)   | 16x13 (x6)                                 | 19x15.5 (x6)                         |
| 3.0g                  | 171795       |  |                                      |
| 3.5g                  | 121306       |  |                                      |
| 4.0g                  | 171776       | 121317                                     | 486086                               |
| 4.5g                  | 172021       | 486085                                     | 486087                               |
| 5.0g                  | 171852       | 171800                                     | 486088                               |
| 5.5g                  | 486078       | 171910                                     | 486089                               |
| 6.0g                  | 219509       | 171814                                     | 486090                               |
| 6.5g                  | 486079       | 486084                                     | 486091                               |
| 7.0g                  | 486080       | 171977                                     | 486092                               |
| 7.5g                  | 486081       |  | 486093                               |
| 8.0g                  | 171787       | 171829                                     | 486094                               |
| 8.5g                  |              | 486083                                     | 486095                               |
| 9.0g                  | 211421       | 486082                                     |                                      |



**GALET PROGRAMMABLE PAVÈSE (XI)**

|        |                            |      |
|--------|----------------------------|------|
| 472549 | type MBK                   | 5x12 |
| 472550 | type PEUGEOT               | 6x13 |
| 472552 | type SUZUKI   MORINI   TGB | 7x12 |
| 472551 | type PIAGGIO 1999->        | 9x15 |



472549



472550



472552



472551



**GALET TYPE ORIGINE (X6)**

|        |      |       |
|--------|------|-------|
| 460609 | 5.5g | 15x12 |
|--------|------|-------|





GALET



GALET 4 JEUX DE 6

|        |                           |        |
|--------|---------------------------|--------|
| 15x12  |                           |        |
| 1984   | 2.5g   3.0g   3.5g   4.0g | 242010 |
| 334935 | 3.5g   4.0g   4.5g   5.0g | 242008 |
| 480215 | 4.5g   5.0g   5.5g   6.0g | 242402 |
| 1985   | 5.5g   6.0g   6.5g   7.0g | 242013 |
| 1986   | 6.5g   7.0g   8.0g   9.0g | 242015 |
| 16x13  |                           |        |
| 367477 | 3.5g   4.0g   4.5g   5.0g | 242411 |
| 1981   | 4.2g   5.1g   5.6g   6.3g | 242020 |
| 1982   | 5.5g   6.0g   6.5g   7.0g | 242413 |
| 1983   | 6.5g   7.0g   8.0g   9.0g | 242025 |



GALET POUR VARIATEUR SUPER RACE (X9)

|        |        |      |
|--------|--------|------|
| 468177 | 16x9.7 | 3.5g |
| 468178 | 16x9.7 | 4.0g |
| 468179 | 16x9.7 | 4.5g |
| 468180 | 16x9.7 | 5.0g |



COUVERCLE DE GALET (JEU)

|      |       |
|------|-------|
| 1979 | 15x12 |
| 1980 | 16x13 |



GALET PROGRAMMABLE

|        |       |          |
|--------|-------|----------|
| 485987 | 15x12 | type MBK |
|--------|-------|----------|





## VARIATEUR S3R

|        |  |
|--------|--|
| 324327 | BOOSTER   BW'S ->2003   NITRO   AEROX   SR50       |
| 465293 | BOOSTER   BW'S 2004->                              |
| 324335 | SPEEDFIGHT   TREKKER   BUXY   LUDIX   JET   KISBEE |



## VARIATEUR S2BR

|        |  |
|--------|--|
| 441853 | BOOSTER ->2003   NITRO   SR50   F12   OVETTO |
| 465292 | BOOSTER   BW'S 2004->                        |
| 441854 | SPEEDFIGHT   TREKKER   BUXY   LUDIX   JET    |
| 441855 | TYPHOON   NRG   NTT   STROM ->1999           |
| 441856 | TYPHOON   NRG 1999->   STALKER   DNA         |
| 468264 | KEEWAY   CPI                                 |



## VARIATEUR SIR

|        |   |
|--------|---|
| 260020 | BOOSTER   BW'S   NITRO   AEROX   SR50   F12 |
| 264192 | SPEEDFIGHT   TREKKER   LUDIX   JET   KISBEE |
| 264226 | ST50L                                       |
| 264237 | BIG MAX                                     |



## VARIATEUR MULTIVAR

|        |  |
|--------|--|
| 1913   | BOOSTER   BW'S   NITRO   AEROX   SR50            |
| 478045 | BOOSTER X   BOX   OVETTO   NEOS   AEROX 4 temps  |
| 165592 | SPEEDFIGHT   TREKKER   LUDIX   VIVACITY   KISBEE |
| 287291 | TYPHOON   NRG   STALKER   ZIP                    |
| 461283 | TYPHOON   NRG   STALKER   ZIP 2000->             |
| 476499 | KYMCO 4 temps   SYM 4 temps                      |
| 484504 | CPI   KEEWAY 2 temps                             |
| 484797 | SYM JET 2 temps                                  |
| 487017 | SYM SYMPHONY   SPEEDFIGHT 3                      |





**MALOSSI**

## VARIATEUR MULTIVAR MHR

466629 BOOSTER | BW'S | NITRO | AEROX



**MALOSSI**

## VARIATEUR MULTIVAR MHR OVER RANGE

465037 BOOSTER | NITRO | AEROX | OVETTO | NEOS | STUNT | SLIDER | SR50 | F12



**polini**  
motori

## VARIATEUR HI SPEED

- 475658 BOOSTER | STUNT | NITRO | OVETTO
- 475659 PIAGGIO TYPHOON | NRG | STALKER
- 460857 LUDIX | JET FORCE | KISBEE | VIVACITY
- 492421 ZIP | FLY | LIBERTY | ET4 | LX | VESPA
- 492423 VIVACITY 3 | SPEEDFIGHT 3 | TWEET
- 494359 KYMCO 2 temps
- 495109 KEEWAY F-ACT | FOCUS | CPI



**polini**  
motori

## VARIATEUR HI SPEED ÉVOLUTION

483709 BOOSTER | STUNT | NITRO





## VARIATEUR SPEED CONTROL

|        |                               |
|--------|-------------------------------|
| 449792 | BOOSTER   BW'S   NITRO   SR50 |
| 1922   | SPEEDFIGHT   TREKKER   BUXY   |



## VARIATEUR GP TROPHY

|        |                                     |
|--------|-------------------------------------|
| 460558 | BOOSTER   BW'S   NITRO   SR50   F1  |
| 484948 | BOOSTER   BW'S   NITRO   SR50   F12 |
| 467279 | TYPHOON   NRG 1999->   STALKER      |



## VARIATEUR

|        |  |
|--------|--|
| 480931 | BUXY   TREKKER   SPEEDFIGHT   LUDIX   KISBEE |
|--------|--|



## VARIATEUR

|        |   |
|--------|---|
| 187346 | BOOSTER   NITRO   SR50   F12   OVETTO   MACHG   |
| 482368 | TREKKER   SPEEDFIGHT   LUDIX   BUXY             |
| 482367 | TYPHOON   RUNNER 50 ->1999                      |
| 483331 | ZIP   TYPHOON   STALKER   LIBERTY   LX   ET4 50 |
| 482369 | KEEWAY   CPI                                    |
| 468858 | SCOOTER CHINOIS 50CC 4 temps   V CLIC   139QMB  |





**TUN'R**

**VARIATEUR RACING**

- 466748 BOOSTER | NITRO | SR50 | F12 | STUNT | OVETTO
- 473411 PEUGEOT LUDIX | KISBEE | VIVACITY 3
- 473410 KEEWAY | CPI 2 temps
- 472633 KEEWAY | CPI 2 temps
- 466750 TYPHOON | NRG | NTT | STROM ->1999

**VARIATION / VARIATION**



**MOTEUR**

**DOPPLER**

**JOUE FIXE VENTILLÉE**

- 268604 BOOSTER | NITRO | SR50 | F12



**MALOSSI**

**JOUE FIXE VENTILÉE**

- 1927 BOOSTER | NITRO | SR50 | F12 | OVETTO



**polini**

**JOUE FIXE VENTILÉE**

- 1928 BOOSTER | BW'S | NITRO | AEROX | SR50



**TOP**  
- performances -

**JOUE FIXE VENTILÉE TYPE ORIGINE**

- 460611 BOOSTER | BW'S | NITRO | AEROX | SR50 | F12





**JOUE FIXE VENTILÉE NOIRE**

472642 BOOSTER | BW'S | NITRO | STUNT | OVETTO



**JOUE FIXE**

476167 LUDIX | SPEEDFIGHT 3 | VIVACITY 3 | KISBEE

210391 TYPHOON | ZIP | NRG | RUNNER

466804 SCOOTER CHINOIS 50 4 temps



**JOUE FIXE VENTILÉE**

268604 BOOSTER | NITRO | SR50



**JOUE FIXE VENTILÉE**

327387 BOOSTER | BW'S | NITRO | AEROX | STUNT

486877 LUDIX | KISBEE | VIVACITY 3 | SPEEDFIGHT

363008 SPEEDFIGHT | TREKKER | VIVACITY

476483 CPI | KEEWAY axe 12mm





**DOPPLER**

## RESSORT VARIATEUR

|               |                                       | dureté | Ø du fil |       |
|---------------|---------------------------------------|--------|----------|-------|
| <b>323984</b> | BOOSTER   BW'S   NITRO   tous modèles |        | 3.8      | blanc |
| <b>323999</b> | BOOSTER   BW'S   NITRO   tous modèles |        | 4.0      | jaune |
| <b>324005</b> | BOOSTER   BW'S   NITRO   tous modèles |        | 4.1      | rouge |
| <b>365512</b> | BOOSTER   NITRO tous modèles          |        | 4.7      | bleu  |
| <b>465294</b> | BOOSTER   BW'S 2004->2007             | +45%   | 4.0      | blanc |
| <b>465295</b> | BOOSTER   BW'S 2004->2007             | +45%   | 4.2      | jaune |
| <b>465297</b> | BOOSTER   BW'S 2004->2007             |        | 4.2      | gris  |
| <b>465296</b> | BOOSTER   BW'S 2004->2007             | +61%   | 4.5      | rouge |
| <b>324010</b> | PEUGEOT   PIAGGIO                     | +31%   | 4.1      | jaune |
| <b>324024</b> | PEUGEOT   PIAGGIO                     | +47%   | 4.2      | rouge |
| <b>365527</b> | PEUGEOT   PIAGGIO                     | +57%   | 4.7      | bleu  |



323984



323999



324005



365512



465297

**MALLOSSI**

## RESSORT VARIATEUR

|               |                        | dureté | Ø du fil |        |
|---------------|------------------------|--------|----------|--------|
| <b>175604</b> | BOOSTER   BW'S   NITRO |        | 3.8      | blanc  |
| <b>175638</b> | BOOSTER   BW'S   NITRO |        | 4.0      | jaune  |
| <b>461288</b> | BOOSTER   NITRO   SR50 |        | 4.1      | rouge  |
| <b>477463</b> | PEUGEOT   PIAGGIO      | +106%  |          | bleu   |
| <b>477461</b> | PEUGEOT   PIAGGIO      | +60%   |          | vert   |
| <b>461289</b> | PEUGEOT                | +35%   | 4.1      | jaune  |
| <b>495991</b> | PEUGEOT                | +5%    | 4.1      | blanc  |
| <b>167815</b> | PEUGEOT                | +40%   | 4.2      | rouge  |
| <b>477462</b> | PEUGEOT   PIAGGIO      | +82%   |          | violet |

### Contrôleur de torsion

|               |                                       |  |  |  |
|---------------|---------------------------------------|--|--|--|
| <b>489991</b> | BOOSTER   BW'S   NITRO   AEROX   SR50 |  |  |  |
|---------------|---------------------------------------|--|--|--|



175604



175638



461288



477463



477462



## RESSORT VARIATEUR EVO SLIDER

|        |                 | Ø du fil |
|--------|-----------------|----------|
| 477219 | BOOSTER   NITRO | 3.6      |
| 477220 | BOOSTER   NITRO | 3.8      |

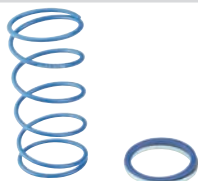

# VARIATION / VARIATION



## RESSORT VARIATEUR ÉVOLUTION

|        |                        | dureté |
|--------|------------------------|--------|
| 194397 | BOOSTER   NITRO   SR50 | +55%   |



## RESSORT VARIATEUR

|        |   | dureté |        |
|--------|---|--------|--------|
| 460554 | BOOSTER   NITRO   SR50   F12                              |        | rose   |
| 460553 | BOOSTER   NITRO   SR50   F1                               |        | violet |
| 460552 | BOOSTER   NITRO   SR50   F12                              |        | vert   |
| 467283 | BOOSTER   NITRO   SR50   F12 kit de 3 ressorts différents |        |        |
| 460557 | PEUGEOT   PIAGGIO   | +30%   | rose   |
| 460556 | PEUGEOT   PIAGGIO   | +22%   | violet |
| 460555 | PEUGEOT   PIAGGIO   | +15%   | vert   |
| 467284 | PEUGEOT   PIAGGIO kit de 3 ressorts différents            |        |        |



460554



460553



460552



## RESSORT VARIATEUR

|        |  |       |
|--------|--|-------|
| 472603 | BOOSTER   NITRO   SR50                       | blanc |
| 472604 | BOOSTER   NITRO   SR50                       | jaune |
| 472605 | BOOSTER   NITRO   SR50                       | rouge |
| 472607 | RESSORT VARIATEUR SCOOTER TUN'R BLE U ADAPT. | bleu  |



472603



472604



472605



472607





## PIÈCES DÉTACHÉES VARIATEUR



324077

contrepoids variateur S3R BOOSTER | BW'S | NITRO | AEROX | SPEEDFIGHT | TREKKER | TKR | BUXY



440173

masselotte S3R (x3) avec axe, vis et contrepoids BOOSTER | SPEEDFIGHT

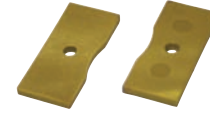

455354

plaquette d'appui masselotte ER3 jaune (x2) pour cyclo



440171

guide + patin masselotte S3R BOOSTER | BW'S | NITRO | AEROX | SPEEDFIGHT



462203

guide S2B R (x3)



### GUIDE VARIATEUR

477543 pour 50 (x3)



### GUIDE VARIATEUR

462421 guide variateur BOOSTER | BW'S | NITRO | SR50 | F12



### GUIDE VARIATEUR MULTIVAR

1948 x3



### GUIDE VARIATEUR

483686 guide variateur (x3) BOOSTER | BW'S | NITRO | AEROX | OVETTO | NEOS | STUNT | SLIDER

482668 guide variateur (x3) TREKKER | SEEDFIGHT | VIVACITY | LUDIX | ZIP | TYPHOON | STALKER



483686



482668



460608

cage aiguille roue libre BOOSTER | BW'S | NITRO | AEROX 57x61x10



461205

écrou variateur M10x1.25 BOOSTER | BW'S | NITRO | AEROX | OVETTO | NEOS | STUNT | SLIDER livré avec rondelle



482371

écrou variateur M10x1.25 BOOSTER | NITRO | OVETTO



### PIÈCES DÉTACHÉES VARIATEUR



**460607**

roue libre démarreur BOOSTER | BW'S | NITRO | AEROX | SR50 | F12



**460561**

rondelle calage BOOSTER | BW'S | NITRO | SR50 | F12



**460562**

rondelle calage TYPHOON | NRG | NTT



**482118**

couronne démarreur complète + roue libre + cage à aiguille BOOSTER | BW'S | NITRO | AEROX



**482119**

couronne démarreur complète + roue libre + cage à aiguille CPI | KEEWAY



**253366**

écrou variateur | rotor | embrayage BUXY | TYPHOON | STALKER (H10x125)



**482372**

écrou tambour embrayage M10x1.25 BOOSTER | NITRO | OVETTO | ZIP | NRG



**293040**

étoile joue fixe BOOSTER | BW'S | NITRO | OVETTO | STUNT | JOG R



**466806**

étoile joue fixe axe 12mm CPI 50CC | KEEWAY



**466807**

étoile joue fixe SPEEDFIGHT | TREKKER | VIVACITY | LUDIX | KISBEE 2 temps

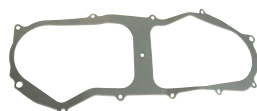

**268441**

joint carter kick | variateur NITRO | AEROX | SR50 | F12 | MACH G | OVETTO | NEOS



**484193**

joint carter kick | variateur KYMCO AGILITY | VIVALITY 4temps | V-CLIC (moteur GY6)

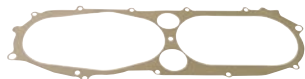

**4133**

joint carter kick variateur BOOSTER | BW'S | STUNT | ROCKET



**297050**

roue libre démarreur BOOSTER | BW'S | NITRO | AEROX | OVETTO | NEOS



**485868**

roue libre démarreur CPI | KEEWAY



**479775**

turbine ZIP | NRG | TYPHOON | SR50 | STALKER | VESPA 50 ET2 | modèle 1999->



**485671**

turbine GY6 | 139QMB | KYMCO | SYM | KISBEE



**489829**

flasque BOOSTER | BW'S | NITRO | AEROX | SR50 | F12



**PIÈCES DÉTACHÉES VARIATEUR**



**CARTER DE KICK NOIR**

479421 NITRO | SR50



**PIÈCES DÉTACHÉES VARIATEUR**

479583 étoile joue fixe TYPHOON | STALKER | ZIP | SR50 | FLY

484621 étoile, rocher de kick KISBEE | SYM | AGILITY | KYMCO



**VARIATEUR ER3**

292517 103 VOGUE | SP | MVL montage embrayage

292521 103 SP | MVL montage sans embrayage

292555 103 SPX | RCX

292547 MBK 51 montage sans embrayage

292536 MBK 51 kick, fonction embrayage

324354 TYPHOON | NRG 1999-> | STALKER | DNA



**VARIATEUR ER2**

254946 103 SP | VOGUE | MVL montage embrayage

216552 103 VOGUE | MVL | SP montage sans embrayage

216548 103 SPX | RCX

216567 MBK 51 montage sans embrayage

251397 MBK 51 kick, fonction embrayage





PIÈCES DÉTACHÉES VARIATEUR



VARIATEUR ERI

264226 FOX | FXR | WALLAROO

279498 103 SPX | RCX



VARIATEUR

1919 103 SPX | RCX



VARIATEUR

806 103 SP | MVL | VOGUE avec embrayage

4188 MBK 51 avec embrayage



POULIE MOTRICE AVEC EMBRAYAGE ( COMPLET)

480970 103 | VOGUE pour moteur non équipé de variateur

3328 CIAO PX

480960 CLUB | 41 | AV85 pour moteur non équipé de variateur



480970



3328



480960



**DOPPLER**

# VARIATION / VARIATION

**MOTEUR**

## PIÈCES DÉTACHÉES VARIATEUR

|               |   |  |
|---------------|---|--|
| <b>281107</b> | joue fixe   | ER2   ER3   103 SP   VOGUE   MVL avec embrayage    |
| <b>449733</b> | joue fixe   | ER3   103 SP sans embrayage                        |
| <b>255608</b> | joue fixe   | ER2   ER3 103 SPX   RCX                            |
| <b>255627</b> | joue fixe   | ER2   ER3   51 avec système embrayage              |
| <b>255612</b> | joue fixe   | ER2   103 SP   MBK 51 sans embrayage               |
| <b>256092</b> | joue mobile variateur   | ER2   103 SPX   RCX                                |
| <b>329007</b> | joue mobile variateur   | ER2 MBK 51   103 SP   MVL                          |
| <b>324096</b> | joue mobile variateur   | ER3   103 SPX   RCX                                |
| <b>324081</b> | joue mobile variateur   | ER3   103 SP (D104)                                |
| <b>329011</b> | joue mobile variateur   | ER3 P   MBK 51 (D100)                              |
| <b>196366</b> | arrache variateur   | MBK 51   |
| <b>455354</b> | plaquette d'appui masselottes jaune (x2)                          | ER3  |
| <b>324172</b> | masselotte variateur (x2)   | ER3  |
| <b>324187</b> | axe masselotte (x2)   | ER3  |
| <b>324062</b> | contrepoids, poids masselotte                                     | ER3   BIDALOT                                      |
| <b>293949</b> | colonnette embrayage variateur (x2)                               | ER2   ER3   103 SP                                 |
| <b>253859</b> | colonnette variateur (x1)   | ER2   ER3  |
| <b>473467</b> | colonnette de poulie d'embrayage                                  | ER2   103   MVL   MBK 51                           |
| <b>255631</b> | bague de colonnette variateur                                     | ER2   ER3  |
| <b>324191</b> | bague de colonnette anti-bruit                                    | ER3  |
| <b>255670</b> | bague joue mobile extérieur Ø31mm, intérieur Ø28mm, longueur 30mm |  |
| <b>255665</b> | bague joue mobile   | ER2   ER3 103 SPX   RCX                            |
| <b>255737</b> | écrou flasque + joue fixe SP/51 sans embrayage                    | ER2   ER3 SP   51 avec et sans embrayage           |
| <b>255722</b> | écrou joue fixe   | ER2   ER3   103 SPX   RCX 2                        |
| <b>281092</b> | écrou joue fixe   | ER2   ER3   103 MVL   VOGUE avec embrayage         |
| <b>255741</b> | écrou joue fixe   | ER2   ER3 P   51 avec embrayage                    |
| <b>255703</b> | écrou variateur   | ER2   ER3   103 SPX   RCX                          |
| <b>255699</b> | écrou variateur   | ER2   ER3 MVL   103 SP   51   VOGUE sans embrayage |
| <b>266965</b> | écrou variateur   | ER2   E R3 P   103 SP   VOGUE   SP   GIRAUDO       |
| <b>475620</b> | flasque variateur   | ER2   103 SPX   RCX                                |
| <b>324479</b> | guide variateur   | 1R   ER1   103 SPX   RCX   PEUGEOT                 |
| <b>216571</b> | moyeu variateur   | ER2   ER3   103 SPX   RCX                          |
| <b>255718</b> | moyeu variateur   | ER2   ER3 P   51 MBK avec embrayage                |
| <b>216597</b> | moyeu variateur   | ER2   ER3   51 MBK sans embrayage                  |
| <b>216586</b> | moyeu variateur   | ER2   ER3   103 SP à embrayage                     |
| <b>255684</b> | roulement variateur   | ER2   ER3   51 MBK fonction embrayage              |



281107



256092



196366

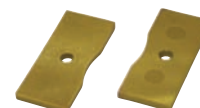

455354



324172



324187



324062



293949



255631



255737



475620



324479



255684



**DOPPLER**

## RESSORT MOTEUR ERI

|        |                             |
|--------|-----------------------------|
| 297246 | 103 SP   MVL réservoir 3.7L |
| 297231 | 103 SPX   RCX               |
| 297257 | 51 MBK                      |
| 495897 | 103 MVL M   VOGUE 1995->    |



## VARIATION / VARIATION

**polini**  
motocross

## RESSORT MOTEUR

|      |                             |
|------|-----------------------------|
| 1995 | 103 SP   MVL réservoir 3.7L |
|------|-----------------------------|



Sélection  
**CGN**

## RESSORT MOTEUR

|        |  |
|--------|--|
| 1994   | 103 SP   MVL renforcé ou chrome réservoir 3.7L |
| 491370 | MBK AV7   AV10   51   41   88 (x2)             |



**MALOSSI**

## PIÈCES DÉTACHÉES VARIATEUR

|      |  |
|------|--|
| 1957 | contrepids, masseotte DOPPLER   BIDALOT   CONTI (x2) |
|------|--|





### INFO + :

Retrouvez les galets de variateur **page 194.**

Sélection  
**CGN**

## PIÈCES DÉTACHÉES VARIATEUR

|               |   |                                    |
|---------------|---|------------------------------------|
| <b>480976</b> | bille embrayage (x1)                          | 103 MVL   VOGUE   SP               |
| <b>480975</b> | bille variateur (x1)                          | 51 MBK                             |
| <b>488670</b> | bague roulement                               | 103 MVL   SP   VOGUE               |
| <b>4195</b>   | cage à aiguille moyeu 51 15x19x22mm           | MBK                                |
| <b>480972</b> | rampe, cage à 3 billes plastique              | MBK                                |
| <b>480973</b> | rampe, cage à 3 galets plastique 15x12mm      | MBK                                |
| <b>1974</b>   | contrepoids variateur jeu                     | 103 SP   MVL   SPX   RCX           |
| <b>814</b>    | écrou joue fixe                               | 103                                |
| <b>481763</b> | écrou variateur M11x100                       | 103 PGT   VOGUE   MVL   SP         |
| <b>480974</b> | écrou variateur                               | 51 MBK                             |
| <b>489838</b> | écrou embrayage                               | 51 MBK avec variateur              |
| <b>481761</b> | entraîneur variateur plastique                | 103   VOGUE   MVL   SP   SPX   RCX |
| <b>813</b>    | joue fixe                                     | 103 SP   MVL   VOGUE               |
| <b>4183</b>   | joue fixe                                     | MBK 51                             |
| <b>494092</b> | joue fixe                                     | 103 SPX   RCX                      |
| <b>812</b>    | joue mobile                                   | 103 SP   MVL   VOGUE               |
| <b>285356</b> | masselotte variateur paire                    | 103 SP   MVL   VOGUE               |
| <b>480971</b> | moyeu de variateur livré sans cage à aiguille | 51V   41V   88   881 MBK           |
| <b>488672</b> | rondelle anti friction paire                  | 103 MVL   SP   VOGUE               |
| <b>488671</b> | rondelle épaulée   came variateur   embrayage | 103 SP   MVL   VOGUE               |



480976



488670



4195



480972



1974



814



481761



494092



285356



480971



488672



**INFO + :**

Retrouvez les outils de démontage d'embrayage **page 640.**



**EMBAYAGE SX86**

|        |  |        |
|--------|--|--------|
| 479530 | SPEEDFIGHT   LUDIX   TYPHOON   NITRO   BOOSTER   JET FORCE | Ø107mm |
|--------|--|--------|



**EMBAYAGE SZR**

|        |  |        |
|--------|--|--------|
| 277897 | SPEEDFIGHT   LUDIX   TYPHOON   NITRO   BOOSTER   JET FOR | Ø107mm |
| 277882 | BOOSTER   BW'S   | Ø105mm |



**EMBAYAGE 3G ÉVOLUTION**

|        |  |        |
|--------|--|--------|
| 495300 | BOOSTER   BW'S   STUNT   SLIDER   NITRO   SR50 | Ø107mm |
| 495301 | PIAGGIO   GILERA                               | Ø107mm |



**EMBAYAGE DELTA CLUTCH**

|        |  |        |
|--------|--|--------|
| 318458 | BOOSTER   NITRO   SR50   F12   OVETTO   MACH G   STUNT | Ø107mm |
| 186369 | SPEEDFIGHT   TREKKER   TYPHOON   RUNNER   NRG   LUDIX  | Ø107mm |



**EMBAYAGE FLY CLUTCH**

|        |  |        |
|--------|--|--------|
| 287867 | BOOSTER   NITRO   SR50   F12   OVETTO   MACH G   STUNT | Ø107mm |
| 207695 | SPEEDFIGHT   TREKKER   TYPHOON   RUNNER   NRG   LUDIX  | Ø107mm |







## EMBAYAGE

|        |  |              |        |
|--------|--|--------------|--------|
| 460547 | BOOSTER   SPEEDFIGHT   TYPHOON   NITRO   SR50  | allege       | Ø107mm |
| 491243 | BOOSTER   BW'S   NITRO   AEROX   NEOS   OVETTO | type origine | Ø107mm |
| 467289 | BOOSTER   BW'S                                 | type origine | Ø105mm |



## EMBAYAGE

|        |   |         |        |
|--------|---|---------|--------|
| 328117 | BOOSTER   SPEEDFIGHT   TYPHOON   NITRO   SR50 |         | Ø107mm |
| 376922 | BOOSTER   SPEEDFIGHT   TYPHOON   NITRO   SR50 |         | Ø107mm |
| 478417 | BOOSTER   BW'S 2 mâchoirs                     | complet | Ø105mm |
| 485870 | CPI   KEEWAY                                  |         | Ø107mm |



485870



## EMBAYAGE

|        |  |         |        |
|--------|--|---------|--------|
| 480674 | BOOSTER   BW'S   NITRO   AEROX   OVETTO   NEOS | complet | Ø107mm |
| 485869 | CPI   KEEWAY complet sans tambour              | complet | Ø107mm |
| 451426 | TYPHOON   TKR   VIVACITY   SPEEDFIGHT   LUDIX  | complet | Ø107mm |



480674



## CLOCHE D'EMBAYAGE SX86

|        |  |        |
|--------|--|--------|
| 482014 | NITRO   BOOSTER   STUNT   OVETTO MINARELLI | Ø107mm |
| 482015 | PEUGEOT   PIAGGIO 50CC                     | Ø107mm |





**TAMBOUR/CLOCHE D'EMBRAYAGE EVO2**

|        |                                      |        |
|--------|--------------------------------------|--------|
| 468392 | NITRO   BOOSTER   SR50   F12         | Ø107mm |
| 468393 | TYPHOON   NRG   SPEEDFIGHT   TREKKER | Ø107mm |



**TAMBOUR/CLOCHE D'EMBRAYAGE SPEED BELL**

|        |  |        |
|--------|--|--------|
| 480987 | NITRO   BOOSTER   SR50   F12           | Ø107mm |
| 480988 | SPEEDFIGHT   TREKKER   LUDIX   TYPHOON | Ø107mm |



**TAMBOUR/CLOCHE D'EMBRAYAGE CLUTCH**

|        |                       |        |               |
|--------|-----------------------|--------|---------------|
| 466533 | BOOSTER   NITRO       | Ø107mm | contour lisse |
| 466535 | TREKKER   LUDIX   NRG | Ø107mm | contour lisse |



**TAMBOUR/CLOCHE D'EMBRAYAGE**

|        |   |        |
|--------|---|--------|
| 460595 | NITRO   BOOSTER   SR50   F12 type origine | Ø107mm |
| 468159 | NITRO   SR50   F12                        | Ø107mm |



**TAMBOUR/CLOCHE D'EMBRAYAGE**

|        |                                |        |
|--------|--------------------------------|--------|
| 378557 | BOOSTER   BW'S   NITRO   AEROX | Ø107mm |
| 480398 | PEUGEOT   PIAGGIO sauf V-CLIC  | Ø107mm |





**DOPPLER**

## CORRECTEUR DE COUPLE S3R

|        |  |       |
|--------|--|-------|
| 324589 | BOOSTER   NITRO   SR50   F12 ->1996                          | Ø33mm |
| 367219 | BOOSTER   BW'S   NITRO   AEROX   SR50   F12 1997->           | Ø34mm |
| 324593 | SPEEDFIGHT   TKR   LUDIX   SYM   PGO   KYMCO 2 temps 4 temps |       |
| 468385 | KEEWAY   CPI   BENELLI   MALAGUTTI   MBK 100CC               |       |



## POULIE RÉCEPTRICE

|        |   |
|--------|---|
| 467281 | BOOSTER   NITRO   SR50   F12   STUNT   MACH |
| 497530 | PEUGEOT   PIAGGIO   GILERA                  |



## POULIE RÉCEPTRICE

|        |                                  |        |
|--------|----------------------------------|--------|
| 482349 | BOOSTER   NITRO   OVETTO   STUNT | Ø115mm |
| 482350 | PEUGEOT   SCOOT CHINOIS          | Ø118mm |



**DOPPLER**

## BOÎTE DE RESSORTS D'EMBAYAGE

|        |                  |     |
|--------|------------------|-----|
| 480282 | BOOSTER   NITRO  | x60 |
| 480281 | SPEEDFIGHT   TKR | x90 |

- ↳ chrome: +15%
- ↳ or: +30%
- ↳ noir: +50%



**DOPPLER**

## RESSORTS D'EMBAYAGE

|        |  |     |        |     |
|--------|--|-----|--------|-----|
| 479867 | BOOSTER   NITRO   OVETTO   STUNT         | 15% | chrome | x20 |
| 479868 | BOOSTER   NITRO   OVETTO   STUNT         | 30% | or     | x20 |
| 479869 | BOOSTER   NITRO   OVETTO   STUNT         | 50% | noir   | x20 |
| 479837 | SPEEDFIGHT   TREKKER   TYPHOON   STALKER | 15% | chrome | x30 |
| 479865 | SPEEDFIGHT   TREKKER   TYPHOON   STALKER | 30% | or     | x30 |
| 479866 | SPEEDFIGHT   TREKKER   TYPHOON   STALKER | 50% | noir   | x30 |



479867



479868



479869



**DOPPLER**

## RESSORTS D'EMBRAYAGE

|        |   |     |
|--------|---|-----|
| 323783 | NITRO   BOOSTER   SR50   F12   STUNT   OVETTO | 3x3 |
| 277935 | SPEEDFIGHT   TREKKER   TYPHOON   NRG          | 3x3 |
| 277901 | pour embrayage DOPPLER S2R                    | 3x3 |
| 277927 | BOOSTER   BW'S 2 mâchoires Ø105mm             | 3x2 |



**DOPPLER**

## RESSORTS D'EMBRAYAGE SX86

|        |        |       |    |
|--------|--------|-------|----|
| 482764 | Ø1.7mm | blanc | x3 |
| 482766 | Ø1.8mm | rouge | x3 |



**MALOSSI**

## RESSORTS D'EMBRAYAGE

|        |  |                  |     |
|--------|--|------------------|-----|
| 482245 | NITRO   BOOSTER   FLIPPER   SR50   F12 type or | vert/rouge/bleu  | 3x3 |
| 477464 | NITRO   AEROX   BOOSTER   BW'S   SR50   F12    | noir             | x3  |
| 3343   | SPEEDFIGHT   TREKKER   TYPHOON   NRG           | noir/blanc/jaune | 3x3 |
| 493134 | pour embrayage DELTA   FLY clutch              | blanc/jaune/vert | 3x3 |



**TOP**  
performances

## RESSORTS D'EMBRAYAGE RENFORCÉ

|        |                                     |        |
|--------|-------------------------------------|--------|
| 460551 | NITRO   BOOSTER   SPEEDFIGHT   SR50 | Ø107mm |
|--------|-------------------------------------|--------|



**LeoVince**

## RESSORTS D'EMBRAYAGE

|        |                                      |     |
|--------|--------------------------------------|-----|
| 321017 | NITRO   BOOSTER   SR50   F12         | 3x3 |
| 321063 | SPEEDFIGHT   TREKKER   TYPHOON   NRG | 3x3 |



**TUN'R**

## RESSORTS D'EMBRAYAGE

|        |   |                  |     |
|--------|---|------------------|-----|
| 472608 | BOOSTER   NITRO   SR50   OVETTO   STUNT | noir/blanc/jaune | 3x3 |
| 472609 | PIAGGIO   PEUGEOT                       | noir/blanc/jaune | 3x3 |



**TEKNIX**  
Original Quality Controller

## PIÈCES DÉTACHÉES EMBRAYAGE

|        |   |
|--------|---|
| 327417 | écrou embrayage BOOSTER   BW'S   SPEEDFIGHT   TYPHOON   NITRO   AEROX   SYM |
| 253366 | écrou variateur, rotor, embrayage TYPHOON   STALKER   MIO x125              |





## DISQUE D'EMBRAYAGE RENFORCÉ

|        |   |    |
|--------|---|----|
| 333499 | AM6   | x5 |
| 333503 | DERBI SENDA   GPR   RS50   RS4   RX50   SMT   RCR | x5 |



## DISQUE D'EMBRAYAGE RENFORCÉ

|        |   |    |
|--------|---|----|
| 450473 | AM6   | x5 |
| 450476 | DERBI   SENDA   GPR   RS50   RS4   RX50   SMT   RCR | x5 |

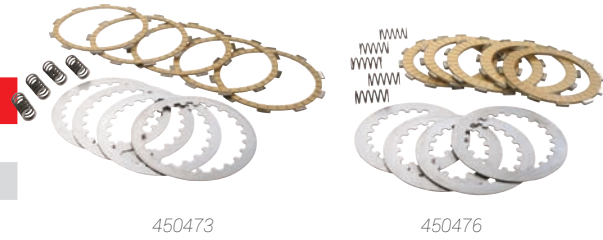

## DISQUE D'EMBRAYAGE

|        |   |                         |    |
|--------|---|-------------------------|----|
| 460532 | AM6   | avec ressorts renforcés | x4 |
| 465490 | DERBI   SENDA   GPR   RS50   RS4   RX50   SMT   RCR | avec ressorts renforcés | x5 |



## DISQUE D'EMBRAYAGE RACING

|        |   |    |
|--------|---|----|
| 473030 | DERBI   SENDA   GPR   RS50   RS4   RX50   SMT   RCR | x5 |
|--------|---|----|



## DISQUE D'EMBRAYAGE

|        |   |    |
|--------|---|----|
| 451380 | AM6   | x4 |
| 451381 | DERBI   SENDA   GPR   RS50   RS4   RX50   SMT   RCR | x4 |
| 475158 | SUZUKI SMX   RMX 50                                 | x3 |



## DISQUE D'EMBRAYAGE

|        |              |    |
|--------|--------------|----|
| 494601 | MINARELLI P4 | x4 |
|--------|--------------|----|





**JEU DE RESSORTS DISQUE D'EMBAYAGE RENFORCÉ**

|        |                     |    |
|--------|---------------------|----|
| 461244 | AM6                 | x4 |
| 461245 | SENDA   GPR   DERBI | x4 |



**RESSORT DISQUE D'EMBAYAGE RENFORCÉ X4**

|        |     |       |
|--------|-----|-------|
| 467287 | AM6 | 100kg |
|--------|-----|-------|



**EMBAYAGE MOTO**

|        |     |  |
|--------|-----|--|
| 486146 | AM6 | tambour+disques+ressort+flasque pression |
|--------|-----|--|







**EMBAYAGE MOTO**

|        |                                |                                 |
|--------|--------------------------------|---------------------------------|
| 494806 | CPI   KEEWAY   GENERIC   THORN | tambour+disques+ressort+flasque |
|--------|--------------------------------|---------------------------------|



**JOINT DE CARTER D'EMBAYAGE**

|        |                                   |   |
|--------|-----------------------------------|---|
| 460632 | AM6 type origine                  |  |
| 475683 | AM6                               |   |
| 479920 | SENDA   GPR   DERBI 2006-> EURO 3 |   |
| 482055 | SENDA   DERBI   GPR 2006-> EURO 3 |   |
| 482054 | SENDA   GPR   DERBI ->2006 EURO 2 |   |



460632



482054



475683

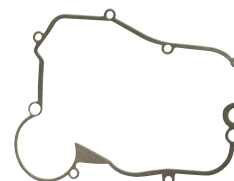

479920



## BIELLETTE D'EMBAYAGE

460625 AM6 avec axe



## BIELLETTE D'EMBAYAGE

|        |   |         |
|--------|---|---------|
| 464962 | DERBI   SENDA   GPR   RS50   RS4   RCR   RX   SMT | argent  |
| 464963 | DERBI   SENDA   GPR   RS50   RS4   RCR   RX   SMT | bleu    |
| 464964 | DERBI   SENDA   GPR   RS50   RS4   RCR   RX   SMT | carbone |
| 464965 | DERBI   SENDA   GPR   RS50   RS4   RCR   RX   SMT | rouge   |



**INFO + :**  
Retrouvez les câbles d'embrayage **page 526**.  
Retrouvez les joues de variateur **page 203**.



## TAMBOUR/CLOCHE D'EMBAYAGE

|        |                             |
|--------|-----------------------------|
| 802    | 103 SP   MVL   VOGUE        |
| 4177   | MBK 51                      |
| 4175   | MBK 51 avec variateur       |
| 480946 | MBK 51/41/85 sans variateur |

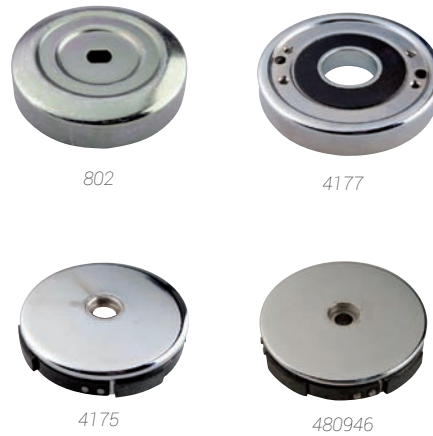

## TAMBOUR CLOCHE D'EMBAYAGE

2005 103 SP | MVL | VOGUE (ventilé)



## POULIE MOTRICE AVEC EMBRAYAGE COMPLET

|        |  |
|--------|--|
| 480970 | 103   VOGUE pour moteur non équipé de variateur      |
| 3328   | CIAO PX pour moteur non équipé de variateur          |
| 480960 | CLUB   41   AV85 pour moteur non équipé de variateur |





**MÂCHOIRE D'EMBRAYAGE POUR POULIE D'EMBRAYAGE DOPPLER ER2**

800 RCX | SPX poulie origine



**MÂCHOIRE D'EMBRAYAGE POUR POULIE D'EMBRAYAGE DOPPLER (X3)**

369871 103 SPX | RCX poulie origine



**MÂCHOIRE D'EMBRAYAGE**

|        |                      |                           |    |
|--------|----------------------|---------------------------|----|
| 798    | 103 SP   MVL   VOGUE | mâchoire de mise en route | x2 |
| 4179   | MBK 51               | mâchoire de mise en route | x2 |
| 482912 | CIAO PX avec ressort | mâchoire de mise en route | x3 |
| 3334   | CIAO PX              | mâchoire de mise en route | x2 |



798



4179



482912



3334



**RESSORT D'EMBRAYAGE**

|        |                                    |    |
|--------|------------------------------------|----|
| 265423 | 103 SPX   RCX   poulie DOPPLER ER2 | x3 |
| 489600 | 103 MVL   VOGUE   SP               | x1 |
| 803    | 103 MVL   SP   VOGUE               |    |
| 178732 | CIAO PX                            | x1 |



265423



489600



803



178732



**PIÈCES DÉTACHÉES D'EMBRAYAGE**

|        |  |
|--------|--|
| 796    | disque d'embrayage 103 SP   MVL   VOGUE                                    |
| 480976 | bille d'embrayage 103 MVL   VOGUE   SP x1                                  |
| 481760 | plateau d'appui 103 MVL   VOGUE   SP support bille embrayage               |
| 4189   | clip extérieur d'embrayage MBK 51 Ø15mm                                    |
| 4191   | clip extérieur d'embrayage MBK 51 Ø22mm                                    |
| 496074 | plateau coupelle avec ressort pour disque d'embrayage 103 MVL   VOGUE   SP |



796



480976



481760



4189



4191



496074



**VIS CLOCHE D'EMBRAYAGE**

4193 MBK 51 Ø4x14mm





**TABLEAU D'AFFECTATION PAR VÉHICULE DES COURROIES SCOOTER 50CC**

| Marque         | Modèle                                    | Année début | Année fin | DOPPLER |                 | Monté origine | BANDO  | TEKNIK | DAYCO  | MALOSSI     |              | Kevlar | polini | Origine | TOP    | VANTIGO |
|----------------|---|-------------|-----------|---------|-----------------|---------------|--------|--------|--------|-------------|--------------|--------|--------|---------|--------|---------|
|                |   |             |           | Kevlar  | Fibre renforcée |               |        |        |        | Kevlar belt | Spécial belt |        |        |         |        |         |
| <b>Aprilia</b> | Amico 50 GL   LX   sport                  | 1992        | 1999      | 223337  | 324039          | 321829        | 494759 | 187547 | 4095   | 4096        | 175907       | 475645 | 215567 | 487064  | 467292 |         |
| <b>Aprilia</b> | Area 51 50                                | 1998        | 2002      | 223337  | 324039          | 321829        | 494759 | 187547 | 4095   | 4096        | 175907       | 475645 | 215567 | 487064  | 467292 |         |
| <b>Aprilia</b> | Gulliver 50                               | 1996        | 1999      | 223337  | 324039          | 321829        | 494759 | 187547 | 4095   | 4096        | 175907       | 475645 | 215567 | 487064  | 467292 |         |
| <b>Aprilia</b> | Habana 50 / Custom moteur morini          | 1999        | 2001      |         |                 |               |        |        |        |             |              |        |        |         |        |         |
| <b>Aprilia</b> | Rally 50 AC et LC                         | 1995        | 2004      | 223337  | 324039          | 321829        | 494759 | 187547 | 4095   | 4096        | 175907       | 475645 | 215567 | 487064  | 467292 |         |
| <b>Aprilia</b> | Scarabeo 50                               | 1994        | 2005      | 223337  | 324039          | 321829        | 494759 | 187547 | 4095   | 4096        | 175907       | 475645 | 215567 | 487064  | 467292 |         |
| <b>Aprilia</b> | Scarabeo 50 Ditech                        | 2002        | 2005      |         |                 |               |        |        |        |             |              |        |        |         |        |         |
| <b>Aprilia</b> | Scarabeo 50 4T                            | 2004        | 2004      |         |                 |               | 467627 |        |        |             |              |        |        |         |        |         |
| <b>Aprilia</b> | Scarabeo 50 4T 4V                         | 2010        | 2015      |         |                 |               | 467627 |        |        |             |              |        |        |         |        |         |
| <b>Aprilia</b> | Sportcity 50 One 4T                       | 2009        | 2014      |         |                 |               | 467627 |        |        |             |              |        |        |         |        |         |
| <b>Aprilia</b> | SR50   Racing   Street AC et LC minarelli | 1997        | 2004      | 223337  | 324039          | 321829        | 494759 | 187547 | 4095   | 4096        | 175907       | 475645 | 215567 | 487064  | 467292 |         |
| <b>Aprilia</b> | SR50 / SR50 Ditech moteur morini          | 2001        | 2005      |         |                 |               |        |        |        |             |              |        |        |         |        |         |
| <b>Aprilia</b> | SR50 Motard                               | 2012        |           |         |                 | 467627        |        |        |        |             |              |        |        |         |        |         |
| <b>Aprilia</b> | SR50 R Factory moteur piaggio             | 2005        | 2005      | 223345  |                 | 450764        | 497255 | 187532 | 175915 | 461280      | 461281       |        | 189540 | 467294  |        |         |
| <b>Atala</b>   | Carosello 50                              | 1997        | 2001      | 223337  | 324039          | 321829        | 494759 | 187547 | 4095   | 4096        | 175907       | 475645 | 215567 | 487064  | 467292 |         |
| <b>Benelli</b> | 491 50                                    | 1998        | 2006      | 223337  | 324039          | 321829        | 494759 | 187547 | 4095   | 4096        | 175907       | 475645 | 215567 | 487064  | 467292 |         |
| <b>Benelli</b> | K2 50 AC et VC / Namur                    | 1998        | 2001      | 223337  | 324039          | 321829        | 494759 | 187547 | 4095   | 4096        | 175907       | 475645 | 215567 | 487064  | 467292 |         |
| <b>Benelli</b> | Pepe 50 / LX                              | 1999        | 2012      | 223337  | 324039          | 321829        | 494759 | 187547 | 4095   | 4096        | 175907       | 475645 | 215567 | 487064  | 467292 |         |
| <b>Beta</b>    | Ark 50 AC et LC                           | 1997        | 2008      | 223337  | 324039          | 321829        | 494759 | 187547 | 4095   | 4096        | 175907       | 475645 | 215567 | 487064  | 467292 |         |
| <b>Beta</b>    | Eikon 50                                  | 1999        | 2006      | 223337  | 324039          | 321829        | 494759 | 187547 | 4095   | 4096        | 175907       | 475645 | 215567 | 487064  | 467292 |         |
| <b>Beta</b>    | Quadra 50                                 | 1995        | 1999      | 223337  | 324039          | 321829        | 494759 | 187547 | 4095   | 4096        | 175907       | 475645 | 215567 | 487064  | 467292 |         |
| <b>Beta</b>    | Tempo 50                                  | 1992        | 2001      | 223337  | 324039          | 321829        | 494759 | 187547 | 4095   | 4096        | 175907       | 475645 | 215567 | 487064  | 467292 |         |
| <b>CPI</b>     | Aragon Club 50                            | 2008        | 2014      | 223345  |                 | 450764        | 497255 | 187532 | 175915 | 461280      | 461281       |        | 189540 | 467294  |        |         |

**COURROIE / BELT**
**MOTEUR**

### TABLEAU D'AFFECTATION PAR VÉHICULE DES COURROIES SCOOTER 50CC

| Marque         | Modèle           | Année début | Année fin | DOPPLER |                 | Monté origine | BANDO  | TEKNIJX | DAYCO  | MALOSSI     |              | Kevlar | polini | Origine | TOP    | VENTURO |
|----------------|------------------|-------------|-----------|---------|-----------------|---------------|--------|---------|--------|-------------|--------------|--------|--------|---------|--------|---------|
|                |                  |             |           | Kevlar  | Fibre renforcée |               |        |         |        | Kevlar belt | Special belt |        |        |         |        |         |
| <b>CPI</b>     | Formula 50 R     | 2008        | 2014      | 2233345 |                 | 450764        | 497255 | 187532  | 175915 | 461280      | 461281       | 189540 |        | 467294  |        |         |
| <b>CPI</b>     | Hussar 50        | 2001        | 2005      | 2233345 |                 | 450764        | 497255 | 187532  | 175915 | 461280      | 461281       | 189540 |        | 467294  |        |         |
| <b>CPI</b>     | Oliver 50        | 2003        | 2007      | 2233345 |                 | 450764        | 497255 | 187532  | 175915 | 461280      | 461281       | 189540 |        | 467294  |        |         |
| <b>CPI</b>     | Popcorn 50       | 2001        | 2005      | 2233345 |                 | 450764        | 497255 | 187532  | 175915 | 461280      | 461281       | 189540 |        | 467294  |        |         |
| <b>Derbi</b>   | Atlantis 50      | 1999        | 2012      | 2233345 |                 | 450764        | 497255 | 187532  | 175915 | 461280      | 461281       | 189540 |        | 467294  |        |         |
| <b>Derbi</b>   | Atlantis 50 (4T) | 2004        | 2010      |         |                 |               | 467627 |         |        |             |              |        |        |         |        |         |
| <b>Derbi</b>   | Boulevard 50 2T  | 2009        |           |         |                 |               | 467627 |         |        |             |              |        |        |         |        |         |
| <b>Derbi</b>   | Boulevard 50 4T  | 2009        |           |         |                 |               | 467627 |         |        |             |              |        |        |         |        |         |
| <b>Derbi</b>   | GPI 50           | 2001        | 2012      | 2233345 |                 | 450764        | 497255 | 187532  | 175915 | 461280      | 461281       | 189540 |        | 467294  |        |         |
| <b>Derbi</b>   | Predator 50 AC   | 1999        | 2001      |         |                 |               |        |         |        |             |              |        |        |         |        |         |
| <b>Generic</b> | Ideo 50          | 2006        | 2013      |         |                 |               |        |         |        |             |              |        |        |         |        |         |
| <b>Generic</b> | Roc 50           | 2008        | 2011      |         |                 |               |        |         |        |             |              |        |        |         |        |         |
| <b>Generic</b> | XOR 50           | 2006        | 2012      |         |                 |               |        |         |        |             |              |        |        |         |        |         |
| <b>Gilera</b>  | DNA 50           | 2000        | 2008      | 2233345 |                 | 450764        | 497255 | 187532  | 175915 | 461280      | 461281       | 189540 |        | 467294  |        |         |
| <b>Gilera</b>  | Ice 50           | 2001        | 2003      | 2233345 |                 | 450764        | 497255 | 187532  | 175915 | 461280      | 461281       | 189540 |        | 467294  |        |         |
| <b>Gilera</b>  | Runner 50        | 1998        |           | 2233345 |                 | 450764        | 497255 | 187532  | 175915 | 461280      | 461281       | 189540 |        | 467294  |        |         |
| <b>Gilera</b>  | Stalker 50       | 2004        | 2013      | 2233345 |                 | 450764        | 497255 | 187532  | 175915 | 461280      | 461281       | 189540 |        | 467294  |        |         |
| <b>keeway</b>  | F-act 2T         | 2008        |           | 2233345 |                 | 450764        | 497255 | 187532  | 175915 | 461280      | 461281       | 189540 |        | 467294  |        |         |
| <b>keeway</b>  | Goccia 2T        | 2009        |           | 2233345 |                 | 450764        | 497255 | 187532  | 175915 | 461280      | 461281       | 189540 |        | 467294  |        |         |
| <b>keeway</b>  | Hurricane 2T     | 2006        |           | 2233345 |                 | 450764        | 497255 | 187532  | 175915 | 461280      | 461281       | 189540 |        | 467294  |        |         |
| <b>keeway</b>  | Matrix 2T        | 2006        |           | 2233345 |                 | 450764        | 497255 | 187532  | 175915 | 461280      | 461281       | 189540 |        | 467294  |        |         |
| <b>keeway</b>  | Ry8 2T           | 2010        |           | 2233345 |                 | 450764        | 497255 | 187532  | 175915 | 461280      | 461281       | 189540 |        | 467294  |        |         |
| <b>keeway</b>  | Pixel 2T         | 2010        |           | 2233345 |                 | 450764        | 497255 | 187532  | 175915 | 461280      | 461281       | 189540 |        | 467294  |        |         |
| <b>Kymco</b>   | Agility 50 2T    | 2012        |           |         |                 |               |        | 480685  |        |             |              |        |        |         |        |         |
| <b>Kymco</b>   | Agility 50 4T    | 2005        | 2011      | 487002  |                 |               | 478103 | 468862  |        |             |              |        |        |         | 482296 |         |
| <b>Kymco</b>   | Dink 50 2T       | 2012        |           |         |                 |               |        | 480685  |        |             |              |        |        |         |        |         |
| <b>Kymco</b>   | Dink 50 /LC 4T   | 2000        | 2007      | 487002  |                 |               | 478103 | 468862  |        |             |              |        |        |         | 482296 |         |
| <b>Kymco</b>   | Filly 50 4T      | 1999        | 2001      |         |                 |               | 478104 |         |        |             |              |        |        |         |        |         |
| <b>Kymco</b>   | Heroism 50 4T    | 1995        | 1996      |         |                 |               | 478104 |         |        |             |              |        |        |         |        |         |
| <b>Kymco</b>   | People 50 2T     | 1999        | 2015      |         |                 |               |        | 480685  |        |             |              |        |        |         |        | 482296  |
| <b>Kymco</b>   | Sniper 50 2T     | 1994        | 1996      |         |                 |               | 478104 |         |        |             |              |        |        |         |        |         |
| <b>Kymco</b>   | Super 8 50 4T    | 2007        | 2015      | 487002  |                 |               | 478103 | 468862  |        |             |              |        |        |         |        | 482296  |

**TABLEAU D'AFFECTATION PAR VÉHICULE DES COURROIES SCOOTER 50CC**

| Marque          | Modèle                          | Année début | Année fin | DUPPLER |                 | Monté origine | TEKNIKS | DAVEO  | MALOSSI     |              | Kevlar | Origine | 486 | VANTO  |
|-----------------|---------------------------------|-------------|-----------|---------|-----------------|---------------|---------|--------|-------------|--------------|--------|---------|-----|--------|
|                 |                                 |             |           | Kevlar  | Fibre renforcée |               |         |        | Kevlar belt | Spécial belt |        |         |     |        |
| <b>Kymco</b>    | Super 9 50 AC / LC 4T           | 2002        | 2008      |         |                 |               | 480685  |        |             |              |        |         |     |        |
| <b>Kymco</b>    | Top Boy 50 On Road/Off Road 2T  | 1996        | 2000      |         |                 |               | 480685  |        |             |              |        |         |     |        |
| <b>Kymco</b>    | Vitality 50 4T                  | 2004        | 2006      | 487002  |                 | 478103        | 468862  |        |             |              |        |         |     | 482296 |
| <b>Malaguti</b> | Centro 50 2T                    | 1995        | 2000      | 223337  | 324039          | 494759        | 187547  | 4095   | 175907      | 475645       | 487064 | 467292  |     |        |
| <b>Malaguti</b> | Centro 50 4T                    | 2009        | 2012      |         |                 | 467627        |         |        |             |              |        |         |     |        |
| <b>Malaguti</b> | Ciak 50 2T Master               | 2007        | 2008      | 223337  | 324039          | 494759        | 187547  | 4095   | 175907      | 475645       | 487064 | 467292  |     |        |
| <b>Malaguti</b> | Ciak 50 4T Master               | 2007        | 2008      |         |                 | 467627        |         |        |             |              |        |         |     |        |
| <b>Malaguti</b> | F12 Phantom AC et LC            | 1999        | 2013      | 223337  | 324039          | 494759        | 187547  | 4095   | 175907      | 475645       | 487064 | 467292  |     |        |
| <b>Malaguti</b> | F15 50 Firefox DD LC            | 1996        | 2008      | 223337  | 324039          | 494759        | 187547  | 4095   | 175907      | 475645       | 487064 | 467292  |     |        |
| <b>MBK</b>      | CS50 Mach G AC et LC            | 2002        | 2002      | 223337  | 324039          | 494759        | 187547  | 4095   | 175907      | 475645       | 487064 | 467292  |     |        |
| <b>MBK</b>      | CW50 Booster Rocket   Track ING | 1995        | 2006      | 223337  | 324039          | 494759        | 187547  | 4095   | 175907      | 475645       | 487064 | 467292  |     |        |
| <b>MBK</b>      | CW50 Booster   Spirit           | 1991        | 1991      | 223337  | 324039          | 494759        | 187547  | 4095   | 175907      | 475645       | 487064 | 467292  |     |        |
| <b>MBK</b>      | Booster X 4T                    | 2007        | 2009      |         |                 | 481884        | 484669  |        | 487862      |              |        |         |     |        |
| <b>MBK</b>      | Stunt                           | 2000        | 2000      | 223337  | 324039          | 494759        | 187547  | 4095   | 175907      | 475645       | 487064 | 467292  |     |        |
| <b>MBK</b>      | YN50 Ovetto 2T                  | 1997        | 1997      | 223337  | 324039          | 494759        | 187547  | 4095   | 175907      | 475645       | 487064 | 467292  |     |        |
| <b>MBK</b>      | YN50 Ovetto 4T                  | 2009        | 2009      |         |                 | 481884        | 484669  |        | 487862      |              |        |         |     |        |
| <b>MBK</b>      | YQ50 Nitro 2T                   | 1997        | 1997      | 223337  | 324039          | 494759        | 187547  | 4095   | 175907      | 475645       | 487064 | 467292  |     |        |
| <b>MBK</b>      | YQ50 Nitro 4T                   | 2013        | 2013      |         |                 | 481884        | 484669  |        | 487862      |              |        |         |     |        |
| <b>Peugeot</b>  | Buxy 50                         | 1994        | 1997      | 223350  | 324058          | 321867        | 187528  | 191182 | 175733      | 189554       | 189554 | 467296  |     |        |
| <b>Peugeot</b>  | Django 50 2T                    | 2015        | 2015      | 223350  | 324058          | 321867        | 187528  | 191182 | 175733      | 189554       | 189554 | 467296  |     |        |
| <b>Peugeot</b>  | Django 50 4T                    | 2015        | 2015      |         |                 | 481273        | 486415  |        |             |              |        |         |     |        |
| <b>Peugeot</b>  | Elyseo 50                       | 1999        | 2003      | 223350  | 324058          | 321867        | 187528  | 191182 | 175733      | 189554       | 189554 | 467296  |     |        |

**COURROIE / BELT**
**MOTEUR**

### TABLEAU D'AFFECTATION PAR VÉHICULE DES COURROIES SCOOTER 50CC

| Marque                     | Modèle                           | Année début | Année fin | DOPPLER |                 | Monté origine     | BANDO  | TEKNIK | DATCO  | MALOSGI     |                  | Kevlar | polini | Origine | TOP | vevico |
|----------------------------|----------------------------------|-------------|-----------|---------|-----------------|-------------------|--------|--------|--------|-------------|------------------|--------|--------|---------|-----|--------|
|                            |                                  |             |           | Kevlar  | Fibre renforcée |                   |        |        |        | Kevlar belt | Spécial belt     |        |        |         |     |        |
| <b>Peugeot</b>             | Elystar 50                       | 2003        | 2006      | 223350  | 324058          |                   | 321867 | 187528 | 191182 | 171264      | 175733           | 189554 |        | 467296  |     |        |
| <b>Peugeot</b>             | Jet C-Tech 50                    | 2008        | 2009      | 223350  | 324058          |                   | 321867 | 187528 | 191182 | 171264      | 175733           | 189554 |        | 467296  |     |        |
| <b>Peugeot</b>             | Jet Force 50                     | 2003        | 2006      | 223350  | 324058          |                   | 321867 | 187528 | 191182 | 171264      | 175733           | 189554 |        | 467296  |     |        |
| <b>Peugeot</b>             | Kisbee 2T                        | 2010        |           | 223350  | 324058          |                   | 321867 | 187528 | 191182 | 171264      | 175733           | 189554 |        | 467296  |     |        |
| <b>Peugeot</b>             | Kisbee 4T                        | 2010        |           |         |                 | 481273            |        |        |        |             |                  |        |        |         |     |        |
| <b>Peugeot</b>             | Looxor 50                        | 2001        | 2006      |         |                 | 496654            |        |        |        |             |                  |        |        |         |     |        |
| <b>Peugeot</b>             | Ludix 50                         | 2004        | 2014      | 223350  | 324058          |                   | 321867 | 187528 | 191182 | 171264      | 175733           | 189554 |        | 467296  |     |        |
| <b>Peugeot</b>             | Speedake 50                      | 1994        | 1997      | 223350  | 324058          |                   | 321867 | 187528 | 191182 | 171264      | 175733           | 189554 |        | 467296  |     |        |
| <b>Peugeot</b>             | Speedfight 1 et 2<br>50 AC et LC | 2001        | 2008      | 223350  | 324058          |                   | 321867 | 187528 | 191182 | 171264      | 175733           | 189554 |        | 467296  |     |        |
| <b>Peugeot</b>             | Speedfight 3 50<br>AC LC         | 2009        | 2017      | 223350  | 324058          |                   | 321867 | 187528 | 191182 | 171264      | 175733           | 189554 |        | 467296  |     |        |
| <b>Peugeot</b>             | Speedfight 3 4T                  | 2009        | 2017      |         |                 |                   |        | 486415 |        |             |                  |        |        |         |     |        |
| <b>Peugeot</b>             | Speedfight 4 50<br>AC LC         | 2017        |           | 223350  | 324058          |                   | 321867 | 187528 | 191182 | 171264      | 175733           | 189554 |        | 467296  |     |        |
| <b>Peugeot</b>             | Speedfight 4 4T                  | 2017        |           |         |                 |                   |        | 486415 |        |             |                  |        |        |         |     |        |
| <b>Peugeot</b>             | Squab 50                         | 1994        | 1997      | 223350  | 324058          |                   | 321867 | 187528 | 191182 | 171264      | 175733           | 189554 |        | 467296  |     |        |
| <b>Peugeot</b>             | tweet 4T                         | 2010        |           |         |                 |                   |        | 486415 |        |             |                  |        |        |         |     |        |
| <b>Peugeot</b>             | TKR 50                           | 2003        | 2013      | 223350  | 324058          |                   | 321867 | 187528 | 191182 | 171264      | 175733           | 189554 |        | 467296  |     |        |
| <b>Peugeot</b>             | Trekker 50 Offroad               | 1998        | 2002      | 223350  | 324058          |                   | 321867 | 187528 | 191182 | 171264      | 175733           | 189554 |        | 467296  |     |        |
| <b>Peugeot</b>             | V-Clic 50                        | 2007        | 2013      | 487003  |                 | 478104            |        |        |        |             |                  |        |        |         |     |        |
| <b>Peugeot</b>             | Vivacity 50 1 et 2               | 1999        | 2013      | 223350  | 324058          |                   | 321867 | 187528 | 191182 | 171264      | 175733           | 189554 |        | 467296  |     |        |
| <b>Peugeot</b>             | Vivacity 50 3 2T                 | 2014        |           | 223350  | 324058          |                   | 321867 | 187528 | 191182 | 171264      | 175733           | 189554 |        | 467296  |     |        |
| <b>Peugeot</b>             | Vivacity 50 3 4T                 | 2009        |           |         |                 |                   |        | 486415 |        |             |                  |        |        |         |     |        |
| <b>Peugeot</b>             | Zenith                           | 1994        | 2000      |         |                 |                   |        | 221725 |        |             |                  |        |        |         |     |        |
| <b>Piaggio /<br/>Vespa</b> | ET2 50 2-Takt                    | 1997        | 2001      |         |                 |                   |        | 480686 | 221691 |             |                  |        |        |         |     |        |
| <b>Piaggio /<br/>Vespa</b> | Fly 50 2-Takt                    | 2005        | 2015      | 223345  |                 | 461957;<br>450764 | 497255 | 187532 | 175915 | 461280      | 461281<br>461282 |        |        |         |     |        |
| <b>Piaggio /<br/>Vespa</b> | Fly 50 4-Takt                    | 2005        | 2015      |         |                 |                   | 467627 |        |        |             |                  |        |        |         |     |        |
| <b>Piaggio /<br/>Vespa</b> | Liberty 50 (2T)                  | 1997        | 2008      |         |                 |                   | 467627 |        |        |             |                  |        |        |         |     |        |

**TABLEAU D'AFFECTATION PAR VÉHICULE DES COURROIES SCOOTER 50CC**

| Marque          | Modèle                  | Année début | Année fin | DOPPLER |                 | Monté origine     | BANDO | TEKNIK | DAYCO  | MALOSSI          |              | Kevlar | polini | Origine | TSP    | VANTICO |
|-----------------|-------------------------|-------------|-----------|---------|-----------------|-------------------|-------|--------|--------|------------------|--------------|--------|--------|---------|--------|---------|
|                 |                         |             |           | Kevlar  | Fibre renforcée |                   |       |        |        | Kevlar belt      | Spécial belt |        |        |         |        |         |
| Piaggio / Vespa | Liberty 50 (4T)         | 2000        | 2013      |         |                 | 467627            |       |        |        |                  |              |        |        |         |        |         |
| Piaggio / Vespa | LX50 (2T)               | 2005        | 2013      |         |                 | 478090            |       |        |        | 493408           |              |        |        |         |        |         |
| Piaggio / Vespa | LX50 (4T)               | 2010        | 2013      |         |                 | 478090            |       |        |        | 493408           |              |        |        |         |        |         |
| Piaggio / Vespa | NRG MC1 MC2 MC3         | 1994        | 2015      | 223345  |                 | 461957;<br>450764 |       | 187532 | 175915 | 461281<br>461282 | 461280       |        |        |         |        |         |
| Piaggio / Vespa | TPH50 Typhoon           | 1993        | 2011      | 223345  |                 | 461957;<br>450764 |       | 187532 | 175915 | 461281<br>461282 | 461280       |        |        |         |        |         |
| Piaggio / Vespa | TPH50 Typhoon           | 2011        |           |         |                 | 467627            |       |        |        |                  |              |        |        |         |        |         |
| Piaggio / Vespa | Zip 2T                  | 1993        | 2000      |         |                 | 478089            |       |        | 221691 |                  |              |        |        |         |        |         |
| Piaggio / Vespa | Zip 2T                  | 2000        |           |         |                 | 478090            |       |        |        | 493408           |              |        |        |         |        |         |
| Piaggio / Vespa | Zip 4T                  | 2002        |           |         |                 | 478090            |       |        |        | 493408           |              |        |        |         |        |         |
| Rieju           | Paseo 50                | 2007        | 2008      |         |                 | 478104            |       |        |        |                  |              |        |        |         |        | 482296  |
| Rieju           | Toreo 50 4T             | 2007        | 2008      | 487002  |                 | 478103            |       | 468862 |        |                  |              |        |        |         |        |         |
| Rieju           | RS Sport   Blast urbain | 2013        |           | 223337  | 324039          | 321829            |       | 187547 | 4095   | 175907           | 4096         | 475645 | 215567 | 487064  | 467292 |         |
| SYM             | Fiddel II 50            | 2010        |           |         |                 | 480907            |       |        |        |                  |              |        |        |         |        |         |
| SYM/ Sanyang    | Jet 50                  | 1999        | 2013      | 223350  | 324058          | 478105            |       |        |        |                  |              |        |        |         |        |         |
| SYM/ Sanyang    | Mio 50                  | 2006        | 2015      |         |                 | 484968            |       |        |        |                  |              |        |        |         |        |         |
| SYM/ Sanyang    | Orbit 1 50              | 2000        | 2008      |         |                 | 480907            |       |        |        |                  |              |        |        |         |        |         |
| SYM/ Sanyang    | Orbit II 50             | 2008        | 2013      |         |                 | 486415            |       |        |        |                  |              |        |        |         |        |         |
| SYM/ Sanyang    | Symphony 50             | 2009        | 2015      |         |                 | 486415            |       |        |        |                  |              |        |        |         |        |         |
| Suzuki          | AY50 Katana             | 1997        | 2006      |         |                 |                   |       |        |        |                  |              |        |        |         |        |         |

**COURROIE / BELT**
**MOTEUR**

## TABLEAU D'AFFECTATION PAR VÉHICULE DES COURROIES SCOOTER 50CC

| Marque              | Modèle                        | Année début | Année fin | DAPPLER |                 | Monté origine | BANDO  | TEKNIK | DAYCO | MALOSSI     |              | Kevlar | Origine | TOP    | VANTICO |
|---------------------|-------------------------------|-------------|-----------|---------|-----------------|---------------|--------|--------|-------|-------------|--------------|--------|---------|--------|---------|
|                     |                               |             |           | Kevlar  | Fibre renforcée |               |        |        |       | Kevlar belt | Spécial belt |        |         |        |         |
| <b>Yamaha</b>       | CS50 JOG R AC et LC           | 2002        |           | 223337  | 324039          | 321829        | 494759 | 187547 | 4095  | 4096        | 175907       | 475645 | 487064  | 467292 |         |
| <b>Yamaha</b>       | CW50 BW's   Next   Bump   Spy | 1995        | 2006      | 223337  | 324039          | 321829        | 494759 | 187547 | 4095  | 4096        | 175907       | 475645 | 487064  | 467292 |         |
| <b>Yamaha</b>       | CW50 BW's                     | 1991        |           | 223337  | 324039          | 321829        | 494759 | 187547 | 4095  | 4096        | 175907       | 475645 | 487064  | 467292 |         |
| <b>Yamaha</b>       | BOX X 4T                      | 2007        | 2009      |         |                 | 481884        |        | 484669 |       |             | 487862       |        |         |        |         |
| <b>Yamaha</b>       | Slider                        | 2000        |           | 223337  | 324039          | 321829        | 494759 | 187547 | 4095  | 4096        | 175907       | 475645 | 487064  | 467292 |         |
| <b>Yamaha</b>       | YN50 Neos 2T                  | 1997        |           | 223337  | 324039          | 321829        | 494759 | 187547 | 4095  | 4096        | 175907       | 475645 | 487064  | 467292 |         |
| <b>Yamaha</b>       | YN50 Neos 4T                  | 2009        |           |         |                 |               |        | 484669 |       |             | 487862       |        |         |        |         |
| <b>Yamaha</b>       | YQ50 Aerox 2T                 | 1997        |           | 223337  | 324039          | 321829        | 494759 | 187547 | 4095  | 4096        | 175907       | 475645 | 487064  | 467292 |         |
| <b>Yamaha</b>       | YQ50 Aerox 4T                 | 2014        |           |         |                 | 481884        |        | 450432 |       |             | 487862       |        |         |        |         |
| <b>Rieju</b>        | Paseo 50                      | 2007        | 2008      |         |                 |               | 478104 |        |       |             |              |        |         |        |         |
| <b>Rieju</b>        | Toreo 50 4T                   | 2007        | 2008      | 487002  |                 |               | 478103 | 468862 |       |             |              |        |         |        | 482296  |
| <b>Rieju</b>        | RS Sport   Blast urbain       | 2013        |           | 223337  | 324039          | 321829        | 494759 | 187547 | 4095  | 4096        | 175907       | 475645 | 487064  | 467292 |         |
| <b>SYM</b>          | Fiddel III 50                 | 2010        |           |         |                 |               | 480907 |        |       |             |              |        |         |        |         |
| <b>SYM/ Sanyang</b> | Jet 50                        | 1999        | 2013      | 223350  | 324058          |               | 478105 |        |       |             |              |        |         |        |         |
| <b>SYM/ Sanyang</b> | Mio 50                        | 2006        | 2015      |         |                 |               | 484968 |        |       |             |              |        |         |        |         |
| <b>SYM/ Sanyang</b> | Orbit 1 50                    | 2000        | 2008      |         |                 |               | 480907 |        |       |             |              |        |         |        |         |
| <b>SYM/ Sanyang</b> | Orbit II 50                   | 2008        | 2013      |         |                 |               | 486415 |        |       |             |              |        |         |        |         |
| <b>SYM/ Sanyang</b> | Symphony 50                   | 2009        | 2015      |         |                 |               | 486415 |        |       |             |              |        |         |        |         |
| <b>Suzuki</b>       | AY50 Katana                   | 1997        | 2006      |         |                 |               |        |        |       |             |              |        |         |        |         |

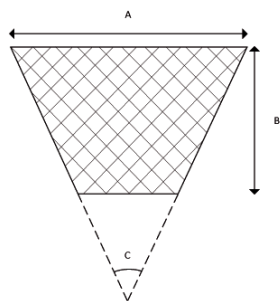

## COURROIE KEVLAR

|        |  | Longueur (mm) | A (mm) | C     |
|--------|--|---------------|--------|-------|
| 223337 | BOOSTER   BW'S   NITRO   AEROX   SR50   F12                      | 747           | 16.5   | 30°   |
| 223350 | SPEEDFIGHT   TREKKER   BUXY   LUDIX   JET FORCE   KISBEE 2 temps | 765           | 17.5   |       |
| 223345 | TYPHOON   NRG   STALKER   ICE   CPI EU1 ->2004                   | 804           | 17.5   | 30°   |
| 487004 | CPI   KEEWAY   | 782           | 16.8   | 28.8° |
| 487002 | SCOOTER CHINOIS   AGILITY   139QMB   QT9   12 4 temps            | 729           | 18     |       |
| 487003 | SCOOTER CHINOIS   V-CLIC   139QMB   QT3   10 4 temps             | 669           | 18     |       |



## COURROIE FIBRE RENFORCÉE

|        |  | Longueur (mm) | A (mm) | B (mm) |
|--------|--|---------------|--------|--------|
| 324039 | BOOSTER   BW'S   NITRO   AEROX   SR50   F12                      | 751           | 16.5   | 8      |
| 324058 | SPEEDFIGHT   TREKKER   BUXY   LUDIX   JET FORCE   KISBEE 2 temps | 765           | 17.5   |        |



## COURROIE MONTÉ ORIGINE

|        |   | Longueur (mm) | A (mm) | B (mm) |
|--------|---|---------------|--------|--------|
| 489885 | BOOSTER   NITRO   SR50 (sans emballage)                         | 751           | 16.5   | 8      |
| 321829 | BOOSTER   NITRO   SR50  | 751           | 16.35  | 8      |
| 450764 | STALKER   RUNNER   TYPHOON 1999->                               | 805           | 18.7   | 8.8    |
| 461957 | TYPHOON ->1999   NRG   NTT ->1997                               | 810           | 17.7   | 7.7    |
| 478089 | PIAGGIO ZIP FAST ->2000 2 temps                                 | 724           | 17.5   | 8      |
| 478090 | VESPA LX   ZIP 50 2000-> 2 et 4 temps                           | 732           | 18.5   | 8      |
| 481884 | OVETTO   BOOSTER X   BOX   AEROX   NITRO 4 temps                | 800           | 15.4   | 8      |
| 467627 | SR MOTARD   TYPHOON 2011->   LIBERTY 2/4 temps   VARVANT 2012-> | 799           | 19     | 9.5    |



**BANDO**
**COURROIE MONTÉ ORIGINE**

|               |  | Longueur (mm) | A (mm) | B (mm) | C   |
|---------------|--|---------------|--------|--------|-----|
| <b>484336</b> | ORBIT 2   FIDDLE 2   SPEEDFIGHT 3   VIVA 3   TWEET 4 temps | 766           | 18.3   | 8      | 28° |
| <b>321867</b> | SPEEDFIGHT   TREKKER   VIVACITY   BUXY   LUDIX             | 755           | 18     | 8      | 30° |
| <b>478103</b> | AGILITY   DINK PEOPLE   COBRA   CHINOIS ROUES 12           | 729           | 18     |        | 30° |
| <b>478104</b> | AGILITY   SNIPER   FIDDLE   V-CLIC   CHINOIS ROUE 10       | 669           | 18     | 8      | 30° |
| <b>478105</b> | SYM 50 JET   RED DEVIL   JUNGLE   MASK   EURO 2            | 737           | 18     | 8      | 30° |
| <b>478517</b> | CPI 2004->   KEEWAY  | 782           | 16     | 8.5    | 28° |
| <b>480907</b> | SYM ORBIT 1   FIDDLE 2 2008->2009                          | 723           | 18     | 8.5    | 30° |
| <b>484968</b> | SYM MOI  | 678           | 18.3   | 8      | 28° |
| <b>481273</b> | KISBEE PEUGEOT 4 temps                                     | 723           | 17.5   | 8.5    | 28° |
| <b>494759</b> | BOOSTER   NITRO   SR50   OVETTO   STUNT                    | 745           | 16.5   | 8      | 30° |
| <b>496652</b> | HONDA 50 WALLAROO   PEUGEOT FOX   FXR                      | 1163          | 15.5   | 8.5    | 30° |
| <b>496654</b> | PEUGEOT LOOXOR   | 815           | 18     |        | 28° |
| <b>496655</b> | HONDA 50 LEAD   METROPOLIS                                 | 714           | 15     |        | 30° |
| <b>496656</b> | TGB  | 846           | 20     |        | 30° |
| <b>496657</b> | HONDA SH FIFTY   X8R                                       | 820           | 18     |        | 30° |

**COURROIE**

|               |   | Longueur (mm) | A (mm) | B (mm) | C   |
|---------------|---|---------------|--------|--------|-----|
| <b>187547</b> | BOOSTER   BW'S   NITRO   AEROX   SR50   F12                     | 751           | 16.5   |        | 30° |
| <b>484669</b> | OVETTO   BOX   NEOS   BOOSTER X   NITRO   AEROX 4 temps         | 805           | 17.9   |        |     |
| <b>187528</b> | SPEEDFIGHT   TREKKER   BUXY   LUDIX   KISBEE   VIVACITY 2 temps | 768           | 18     |        |     |
| <b>187532</b> | TYPHOON ->1999   NRG   NTT   STALKER   CPI EU1 2 temps          | 805           | 18.7   | 8.8    |     |
| <b>480685</b> | KYMCO AGILITY50   PEOPLE   DINK 50 2 temps                      | 736           | 18     | 9.1    |     |
| <b>480686</b> | ZIP   VESPA ET2   | 724           | 17.5   |        |     |
| <b>484670</b> | CPI 2004->   KEEWAY   | 792           | 16.6   | 8.5    | 28° |
| <b>486415</b> | SYM ORBIT 2   FIDDLE 2   SPEEDFIGHT 3   VIVACITY 3 4 temps      | 766           | 18.3   |        |     |
| <b>468862</b> | SCOOTER CHINOIS   AGILITY   139QMB   QT9   12 4 temps           | 729           | 18     | 30     |     |
| <b>468861</b> | SCOOTER CHINOIS   V-CLIC   139QMB   QT3   10 4 temps            | 669           | 18     | 30     |     |
| <b>221725</b> | ZENITH   SV50   BALI   SFX                                      | 693           | 17     | 8      | 30° |







**DAYCO**

## COURROIE

|        |   | Longueur (mm) | A (mm) | B (mm) | C   |
|--------|---|---------------|--------|--------|-----|
| 4095   | BOOSTER   NITRO   SR50   F12                                | 747           | 16.5   | 8.1    | 30° |
| 191182 | SPEEDFIGHT   TREKKER   LUDIX   BUXY   KISBEE   VIVA 2 temps | 755           | 17.5   |        |     |
| 175915 | TYPHOON   NRG 1999->   DNA   ICE   STALKER   SR50 2005->    | 805           | 18.7   | 8.8    |     |
| 221691 | VESPA ET2 1997->1998   ZIP   SFERA ->2000                   | 714           | 18.5   | 8.5    |     |



## COURROIE KEVLAR BELT

|        |  | Longueur (mm) | A (mm) | B (mm) | C   |
|--------|--|---------------|--------|--------|-----|
| 4096   | BOOSTER   NITRO   SR50   OVETTO   STUNT                      | 745           | 16.5   | 8      | 30° |
| 171264 | SPEEDFIGHT   TREKKER   LUDIX   KISBEE   VIVACITY             | 755           | 18     |        | 32° |
| 461280 | STALKER   RUNNER   NRG 1999->   SR50 2005->   TYPHOON 1999-> | 804           | 17.5   |        |     |



## COURROIE SPÉCIAL BELT

|        |   | Longueur (mm) | A (mm) | B (mm) | C   |
|--------|---|---------------|--------|--------|-----|
| 175907 | BOOSTER   NITRO   SR50   OVETTO   STUNT                 | 745           | 16.5   | 8      | 30° |
| 487862 | OVETTO   BOX   NEOS   BOOSTER X   NITRO   AEROX 4 temps | 796           | 16.5   |        | 30° |
| 175733 | SPEEDFIGHT   TREKKER   LUDIX   KISBEE   VIVACITY        | 765           | 17.5   |        |     |
| 461281 | RUNNER   STALKER   ICE   DNA   NRG   TYPHOON 1998->     | 818           | 18.5   | 8      | 30° |
| 461282 | TYPHOON   NRG ->1999   CPI EURO 1 ->2004                | 802           | 17     | 8      | 30° |
| 493408 | PIAGGIO ZIP 2 et 4 temps   VESPA LX 50                  | 730           | 18.5   | 8      | 30° |



## COURROIE

|        |   | Longueur (mm) | A (mm) | B (mm) |
|--------|---|---------------|--------|--------|
| 215567 | BOOSTER   STUNT   NITRO   OVETTO   FLIPPER   SR50   F12                   | 742           | 16.5   |        |
| 487064 | BOOSTER   STUNT   NITRO   OVETTO   SR50 origine                           | 738           | 16.5   |        |
| 475645 | BOOSTER   STUNT   NITRO   FLIPPER   OVETTO   SR50                         | 750           | 16.8   |        |
| 189554 | SPEEDFIGHT   TREKKER   BUXY   LUDIX   VIVACITY 3 2 temps   KISBEE 2 temps | 765           | 17.5   |        |
| 189540 | TYPHOON ->1999   NRG ->1999   CPI EURO 1 ->2004                           | 802           | 16.6   | 8.5    |





## COURROIE / BELT

### COURROIE

|        |  | Longueur (mm) | A (mm) | B (mm) |
|--------|--|---------------|--------|--------|
| 467292 | BOOSTER   NITRO   SR50   F12   BIG MAX               | 751           | 16.9   | 7.8    |
| 467296 | SPEEDFIGHT   LUDIX   TREKKER   BUXY   KISBEE 2 temps | 755           | 18     | 8.3    |
| 467294 | TYPHOON ->1999   NRG     NTT ->1997                  | 805           | 17.2   | 7.8    |
| 467293 | EVOLIS   FIZZ   EQUALIS   SONIC                      | 777           | 18.3   |        |



### COURROIE FIBRE RENFORCÉE

|        |               |         | Longueur (mm) | A (mm) |
|--------|---------------|---------|---------------|--------|
| 327114 | 103 SP   MVL  | crantée | 858           | 13     |
| 327129 | 103 SPX   RCX | crantée | 747           | 15     |
| 327100 | 51 MBK        | crantée | 806           | 14     |



### COURROIE

|        |  |         | Longueur (mm) | A (mm) | B (mm) |
|--------|--|---------|---------------|--------|--------|
| 644    | 101   102 (D213)                           | lisse   | 722           | 10.1   |        |
| 645    | 103 sans variateur (D255)                  | lisse   | 840           | 9.8    | 8.3    |
| 647    | 103 SP   MVL (A48)                         | lisse   | 864           | 12     | 8      |
| 476671 | 103 VOGUE V   MVL M (D501)                 | lisse   | 875           | 12.3   |        |
| 4081   | MBK 51   50   41   40   88   PEUGEOT (D24) | lisse   | 812           | 12.5   |        |
| 4080   | MBK moteur fixe (D22)                      | lisse   | 792           | 14.7   | 7.4    |
| 495561 | MBK 51                                     | crantée | 820           | 13.5   | 7.3    |
| 4091   | 89 MBK (D243CR)                            | crantée | 946           | 17.8   |        |
| 3211   | CIAO PX sans variateur (D237)              | lisse   | 965           | 8.9    | 7.8    |
| 495561 | MBK 51 (D224CR)                            | crantée | 820           | 13.5   | 7.3    |





| COURROIE |                          |         |               |        |        |
|----------|--------------------------|---------|---------------|--------|--------|
|          |                          |         | Longueur (mm) | A (mm) | B (mm) |
| 378155   | 103 FOX   FXR   WALLAROO | crantée | 1173          | 16     |        |
| 187494   | 103 SP   MVL CRANTE      | crantée | 865           | 13     |        |
| 122006   | 103 SP   MVL             | lisse   | 852           | 13     |        |
| 187513   | 103 SPX   RCX            | crantée | 750           | 15.4   |        |
| 187509   | MBK 51                   | crantée | 821           | 14     | 7      |
| 122017   | MBK 51                   | lisse   | 821           | 14     |        |



| COURROIE |                               |         |               |        |
|----------|-------------------------------|---------|---------------|--------|
|          |                               |         | Longueur (mm) | A (mm) |
| 650      | 103 MVL   SP (7169)           | crantée | 858           | 13     |
| 653      | 103 SPX   RCX (7181)          | crantée | 747           | 15     |
| 4084     | MBK 51 CRANTEE (7122)         | crantée | 806           | 14     |
| 3210     | CIAO PX sans variateur        | crantée | 955           | 9.5    |
| 3206     | CIAO PX avec variateur (7153) | crantée | 978           | 12.8   |



| COURROIE SPÉCIALE BELT |  |         |               |              |     |
|------------------------|--|---------|---------------|--------------|-----|
|                        |  |         | Longueur (mm) | Largeur (mm) | C   |
| 652                    | 103 SP   MVL                                       | crantée | 870           | 13           |     |
| 654                    | 103 SPX   RCX                                      | crantée | 747           | 15           |     |
| 461250                 | FOX   FXR 103   WALLAROO                           | crantée | 1180          | 16           |     |
| 4087                   | MBK 51   | crantée | 819           | 14.5         | 30° |
| 481745                 | MBK 51 avec variateur grande plage Ø100 HONDA SH50 |         | 804           | 14           |     |



| COURROIE |                                    |                   |               |              |        |
|----------|------------------------------------|-------------------|---------------|--------------|--------|
|          |                                    |                   | Longueur (mm) | Largeur (mm) | B (mm) |
| 497139   | MBK 51                             | standard          | 806           | 14           | 8      |
| 497140   | MBK 51                             | renforcée         | 806           | 14           | 8      |
| 497141   | MBK 51                             | crantée renforcée | 806           | 14           | 8      |
| 497142   | 103 sans variateur (réservoir 5L)  | lisse             | 847           | 13           | 8      |
| 497143   | 103 VOGUE V   MVL M (réservoir 5L) | lisse             | 850           | 13           | 8      |
| 497144   | 103 SPX/RCX                        | crantée           | 690           | 15           | 10     |
| 497145   | CIAO sans variateur                | crantée           | 966           | 10           | 8      |





### INFO +

Retrouvez les pignons cyclo **page 250.**



## EMBRAYAGE ER86 (RÉGLABLE)

|        |                          |
|--------|--------------------------|
| 491173 | 103 SP   MVL   VOGUE     |
| 491174 | 103 SPX/RCX              |
| 491185 | MBK 51 (axe pour pédale) |

- Comme l'embrayage SX86, la poulie bénéficie d'une possibilité de réglage sans démontage de la cloche.
- Permet un gain de temps sur la mise au point et bénéficie d'une cloche ultra ventilée.
- Tout comme le modèle ER2 dont elle reprend la poulie en aluminium CNC, elle dispose d'une cage à aiguille roue-libre intégrée pour les démarrages.



## POULIE EMBRAYAGE ER2

|        |                        |
|--------|------------------------|
| 288776 | 103 SPX   RCX          |
| 1969   | 103 SP   MVL   VOGUE   |
| 1970   | MBK 51 pignon 11 dents |



## PIÈCES DÉTACHÉES POULIE

|        |                             |   |
|--------|-----------------------------|---|
| 800    | mâchoire embrayage          | 103   MBK 51   RCX   SPX poulie origine             |
| 497094 | pignon poulie embrayage     | ER2   ER86   103 SP   VOGUE   MVL   MBK 51 10 dents |
| 367902 | pignon poulie embrayage     | ER2   ER86   103 SP   VOGUE   MVL   MBK 51 11 dents |
| 329337 | roulement roue libre poulie | ER2 sauf SPX/RCX                                    |
| 473467 | colonnette x1               | 103 MVL   MBK 51                                    |
| 281092 | écrou                       | ER2   ER86   51   103 MVL   103 VOGUE               |
| 265423 | ressort embrayage x3        | ER2   103 SPX   103 RCX   VOGUE   MVC   51          |
| 329807 | axe poulie embrayage        | ER2   ER86   51                                     |
| 384415 | axe poulie embrayage        | ER2   ER86   103 SP   MVL   VOGUE                   |

- La poulie à embrayage centrifuge DOPPLER ER2 est l'atout ultime de votre cyclo
- Elle est entièrement taillée dans la masse en alu
- Elle est constituée d'une cloche en acier embouti, d'une poulie usinée en aluminium et de trois mâchoires d'embrayages
- Les avantages sont incontestables : un régime d'accroche plus élevé donc un démarrage plus franc



800



367902



329337



473467



281092



265423



**DOPPLER**

### POULIE ER2 ALU

210755 103 SP/MVL/VOGUE

210827 MBK 51



## POULIE / PULLEY

MOTEUR

Sélection  
**CGN**

### POULIE

|        |                                |           |
|--------|--------------------------------|-----------|
| 850    | 103 MVL   SP   CHRONO 11 dents | plastique |
| 848    | 103 MVL   SP   CHRONO nu       | plastique |
| 4253   | MBK 11 dents pignon démontable | tôle      |
| 4256   | MBK 11 dents pignon fixe       | tôle      |
| 479167 | MBK 11 dents pignon soudé      | tôle      |
| 3220   | CIAO PX Ø80                    | tôle      |
| 3221   | CIAO PX Ø90 dimension origine  | tôle      |
| 285121 | 103 SP   MVL 11 dents          | alu       |
| 3005   | MBK 51 11 dents                | alu       |



Sélection  
**CGN**

### RONDELLE

|        |  |
|--------|--|
| 4269   | poulie MBK 16x27   MBK 16x32 (épaisseur 0.5/0.7/1.2) fourni avec un kit de clips pour pédalier |
| 491049 | poulie plastique 103 SP   MVL   VOGUE 16x28  |
| 481375 | poulie plastique 103 SP   MVL   VOGUE 16x32 pour pédalier                                      |



Sélection  
**CGN**

### ROULEMENT POULIE/DOUILLE

|      |                          |
|------|--------------------------|
| 866  | poulie 103 longueur 14mm |
| 867  | poulie 103 longueur 18mm |
| 4266 | poulie MBK 51            |



866



867



4266

Sélection  
**CGN**

### BAGUE DE PÉDALIER

|        |                               |
|--------|-------------------------------|
| 4277   | MBK 51                        |
| 489595 | 103 MVL   VOGUE   SP   CHRONO |



4277



489595



**DOPPLER**

## ENGRENAGE

|               |   | Denture  | Démultiplication | Nombre de pièces | Arbre        |
|---------------|---|----------|------------------|------------------|--------------|
| <b>279301</b> | BOOSTER   BW'S   STUNT   SLIDER         | 14-41    | 10%              | 2                | secondaire   |
| <b>263880</b> | BOOSTER   BW'S   STUNT   SLIDER         | 14-42    | 33%              | 2                | secondaire   |
| <b>263894</b> | BOOSTER   BW'S   STUNT   SLIDER         | 15-50    |                  | 2                | secondaire   |
| <b>264127</b> | BOOSTER   BW'S   STUNT   SLIDER         | 41-52/14 |                  | 2                | roue arrière |
| <b>264135</b> | BOOSTER   BW'S   STUNT   SLIDER         | 39-52/15 | 24%              | 2                | roue arrière |
| <b>264097</b> | BOOSTER   BW'S   STUNT   SLIDER 1996->  | 14-42/13 | 21%              | 2                |              |
| <b>283937</b> | NITRO   AEROX   OVETTO   NEOS           | 13-43/14 | 21%              | 2                |              |
| <b>264082</b> | SPEEDFIGHT   TREKKER   VIVACITY   LUDIX | 15-33    | 63%              | 2                |              |
| <b>264101</b> | SPEEDFIGHT   TREKKER   VIVACITY   LUDIX | 15-33/12 | 63%              | 2                |              |
| <b>264116</b> | TYPHOON                                 | 13-37/13 | 25%              | 2                |              |
| <b>493976</b> | GY6   KYMCO   VCLIC 4 temps             | 18-50/15 | 17%              | 2                |              |
| <b>493975</b> | KEEWAY   CPI   GENERIC 2 temps          | 15/50/13 |                  | 3                |              |



279301



263880



263894



264127



264135



264097



283937



264082



264101



264116



493976



493975



**MALOSSSI**

## ENGRENAGE/TRANSMISSION

**484798** LUDIX BLASTER | SPEEDFIGHT 1 et 2 | VIVACITY | 13-35



## ENGRENAGE/TRANSMISSION

|                                   |   |          |            |
|-----------------------------------|---|----------|------------|
| <b>460543</b>                     | BOOSTER   BW'S   NITRO   AEROX                                  | 15-50    |            |
| <b>460545</b>                     | BOOSTER   BW'S   NITRO   AEROX                                  | 15-41    | secondaire |
| <b>465077</b>                     | BOOSTER   | 41-52/16 | secondaire |
| <b>Carter transmission racing</b> |   |          |            |
| <b>479508</b>                     | BOOSTER   BW'S   NITRO   AEROX MINARELLI horizontal et vertical |          |            |



460543



460545



465077



479508



## CARTER TRANSMISSION

**478499** BOOSTER | NITRO | OVETTO | STUNT | ROCKET



## JOINT CARTER TRANSMISSION

**4134** BOOSTER | BW'S | NITRO | AEROX | STUNT | SLIDER | OVETTO | NEOS



**482773** BUXY | TREKKER | VIVACITY | SPEEDFIGHT air et liquide



**482774** LUDIX | JET | SPEEDFIGHT 3 | VIVACITY 3 air et liquide



**467722** SCOOTER CHINOIS 4 temps



4134



482773

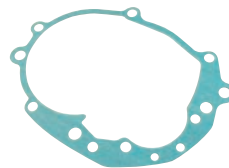

482774



467722



**BOUCHON HUILE**

|               |  |       |
|---------------|--|-------|
| <b>292832</b> | BOOSTER   BW'S   SR50   NITRO   AEROX   STUNT   SLIDER | bleu  |
| <b>292866</b> | BOOSTER   BW'S   SR50   NITRO   AEROX   STUNT   SLIDER | rouge |

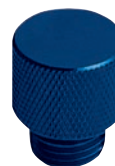

292832

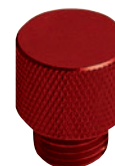

292866



**BOUCHON REMPLISSAGE HUILE (JAUGE)**

|               |                            |
|---------------|----------------------------|
| <b>485938</b> | SCOOTER CHINOIS GY6 139QMB |
|---------------|----------------------------|



**BOÎTE DE VITESSE RACING**

|               |     |
|---------------|-----|
| <b>367261</b> | AM6 |
|---------------|-----|

Rapport de boîte:

|             |       |
|-------------|-------|
| <b>1er</b>  | 34/16 |
| <b>2ème</b> | 30/16 |
| <b>3ème</b> | 29/19 |
| <b>4ème</b> | 27/20 |
| <b>5ème</b> | 26/21 |
| <b>6ème</b> | 25/22 |

|               |          |
|---------------|----------|
| <b>449849</b> | DERBI 6V |
|---------------|----------|

Rapport de boîte:

|             |       |
|-------------|-------|
| <b>1er</b>  | 32/13 |
| <b>2ème</b> | 26/14 |
| <b>3ème</b> | 27/18 |
| <b>4ème</b> | 25/20 |
| <b>5ème</b> | 26/24 |
| <b>6ème</b> | 22/23 |



**BOÎTE DE VITESSE**

|               |     |
|---------------|-----|
| <b>370101</b> | AM6 |
|---------------|-----|

Rapport de boîte:

|             |       |
|-------------|-------|
| <b>1er</b>  | 36/12 |
| <b>2ème</b> | 33/16 |
| <b>3ème</b> | 29/19 |
| <b>4ème</b> | 27/22 |
| <b>5ème</b> | 25/24 |
| <b>6ème</b> | 24/25 |

|               |          |
|---------------|----------|
| <b>449850</b> | DERBI 6V |
|---------------|----------|

Rapport de boîte:

|             |       |
|-------------|-------|
| <b>1er</b>  | 34/11 |
| <b>2ème</b> | 30/15 |
| <b>3ème</b> | 27/18 |
| <b>4ème</b> | 24/20 |
| <b>5ème</b> | 23/22 |
| <b>6ème</b> | 22/23 |







## PIÈCES DÉTACHÉES DE BOÎTE DE VITESSE

|        |  |            | Arbre      | Nombre de dents |
|--------|--|------------|------------|-----------------|
| 462455 | pignon AM6   | 1er        | secondaire | 36              |
| 462456 | pignon AM6   | 2ème       | secondaire | 33              |
| 462448 | pignon AM6   | 3ème  4ème | primaire   | 19-22           |
| 462457 | pignon AM6   | 3ème       | secondaire | 29              |
| 462458 | pignon AM6   | 4ème       | secondaire | 27              |
| 462459 | pignon AM6   | 5ème       | secondaire | 25              |
| 462460 | pignon AM6   | 6ème       | secondaire | 24              |
| 462454 | pignon AM6   | 6ème       | primaire   | 25              |
| 467623 | pignon AM6 longue                                      | 6ème       | primaire   | 26              |
| 462461 | pignon AM6 double intermédiaire (pompe à huile)        |            |            | 13-24           |
| 462420 | arbre/axe sélecteur AM6 boîte de vitesse manuelle      |            |            |                 |
| 460530 | barillet sélection vitesse AM6, desmodromique en ergal |            |            |                 |
| 460626 | clavette pignon AM6 (x5)                               |            |            |                 |
| 460628 | contacteur témoin position point mort AM6              |            |            |                 |



462455



462456



462448



462457



462458



462459



462460



462454



467623



462461



462420



460530



460626



460628

## BOUCHON D'HUILE

460624 AM6 | CPI



473387 DERBI SENDA | GPR | RS | RX | RS4 | RCR | SMT EURO 2 et 3 bleu/alu



497487 DERBI SENDA EURO 3



460624



473387



497487

**INFO +**

 Les schémas des couronnes et pignons se trouvent à partir de la **page 245**.

|                |  |                          | Nombre de dents pignon | Nombre de dents couronne | Pas de chaîne | Ø intérieur | Nombre de fixations | Schéma pignon | Schéma couronne |
|----------------|--|--------------------------|------------------------|--------------------------|---------------|-------------|---------------------|---------------|-----------------|
| <b>APRILIA</b> |  |                          |                        |                          |               |             |                     |               |                 |
| <b>467425</b>  | RS50 1995->1998 (couronne cannelée incurvée) | démultiplication origine | 12                     | 44                       | 420           | 30          |                     | A             | 6               |
| <b>467426</b>  | RS50 1999->2005   TUONO                      |                          | 12                     | 47                       | 420           | 102         | 5                   | A             | 7               |
| <b>478540</b>  | RS50 2006->2010                              | démultiplication origine | 11                     | 53                       | 420           | 108         | 6                   | D             | 16              |
| <b>482389</b>  | RS50 2006->2010                              |                          | 12                     | 53                       | 420           | 108         | 6                   | D             | 16              |
| <b>478540</b>  | RS4  | démultiplication origine | 11                     | 53                       | 420           | 108         | 6                   | D             | 16              |
| <b>482389</b>  | RS4  |                          | 12                     | 53                       | 420           | 108         | 6                   | D             | 16              |
| <b>467438</b>  | RX50 1995->2006                              |                          | 12                     | 50                       | 420           | 105         | 5                   | A             | 8               |
| <b>478556</b>  | RX50 2006->                                  | démultiplication origine | 11                     | 53                       | 420           | 105         | 3x2                 | D             | 13              |
| <b>478553</b>  | RX50 2006->                                  |                          | 13                     | 53                       | 420           | 105         | 3x2                 | D             | 13              |
| <b>467429</b>  | RX50 2006->                                  |                          | 14                     | 53                       | 420           | 105         | 3x2                 | D             | 13              |
| <b>478556</b>  | SX50 2006->2011                              | démultiplication origine | 11                     | 53                       | 420           | 105         | 3x2                 | D             | 13              |
| <b>478553</b>  | SX50 2006->2011                              |                          | 13                     | 53                       | 420           | 105         | 3x2                 | D             | 13              |
| <b>467429</b>  | SX50 2006->2011                              |                          | 14                     | 53                       | 420           | 105         | 3x2                 | D             | 13              |
| <b>478540</b>  | SX50 2011->                                  | démultiplication origine | 11                     | 53                       | 420           | 108         | 6                   | D             | 16              |
| <b>482389</b>  | SX50 2011->                                  |                          | 12                     | 53                       | 420           | 108         | 6                   | D             | 16              |
| <b>467438</b>  | MX50 2003->2005                              |                          | 12                     | 50                       | 420           | 105         | 5                   | A             | 8               |
| <b>BETA</b>    |  |                          |                        |                          |               |             |                     |               |                 |
| <b>490503</b>  | 50 RR 2002->2005                             | démultiplication origine | 12                     | 51                       | 420           | 100         | 3x2                 | A             | 19              |
| <b>478542</b>  | 50 RR 2005->                                 | démultiplication origine | 12                     | 51                       | 420           | 100         | 4                   | A             | 9               |
| <b>478559</b>  | 50 RR SM 2005->                              | démultiplication origine | 11                     | 50                       | 420           | 100         | 4                   | A             | 9               |
| <b>490504</b>  | 50 RR FACTORY 2005->                         | démultiplication origine | 12                     | 50                       | 428           | 100         | 4                   | B             | 9               |
| <b>CPI</b>     |  |                          |                        |                          |               |             |                     |               |                 |
| <b>478545</b>  | 50 SM   SUPERCROSS   BLACK TIGER 2006->2009  | démultiplication origine | 11                     | 62                       | 420           | 110         | 6                   | A             | 30              |
| <b>478546</b>  | SX 2006->2012                                | démultiplication origine | 11                     | 62                       | 420           | 110         | 6                   | A             | 30              |
| <b>DERBI</b>   |  |                          |                        |                          |               |             |                     |               |                 |
| <b>482388</b>  | GPR 2000->2003 (couronne incurvée)           | démultiplication origine | 14                     | 52                       | 420           | 102         | 6                   | D             | 12              |
| <b>478540</b>  | GPR NUDE   RACING 2004->                     | démultiplication origine | 11                     | 53                       | 420           | 108         | 6                   | D             | 16              |
| <b>482389</b>  | GPR NUDE   RACING 2004->                     |                          | 12                     | 53                       | 420           | 108         | 6                   | D             | 16              |
| <b>467428</b>  | SENDA R/SM 1997->1999 (couronne incurvée)    |                          | 12                     | 53                       | 420           | 53          | 4                   | C             | 1               |
| <b>467430</b>  | SENDA SM 1999->2003   R 2001->2002           | démultiplication origine | 13                     | 53                       | 420           | 53          | 3x2                 | D             | 11              |

# KIT CHAINE / CHAIN KIT



## INFO +

Les schémas des couronnes et pignons se trouvent à partir de la **page 245**.



|                 |   |                          | Nombre de dents pignon | Nombre de dents couronne | Pas de chaîne | Ø intérieur | Nombre de fixations | Schéma pignon | Schéma couronne |
|-----------------|---|--------------------------|------------------------|--------------------------|---------------|-------------|---------------------|---------------|-----------------|
| <b>DERBI</b>    |   |                          |                        |                          |               |             |                     |               |                 |
| 478556          | SENDA R X RACE   XTREM 2002->                       |                          | 11                     | 53                       | 420           | 105         | 3x2                 | D             | 13              |
| 478556          | SENDA SM X RACE   XTREM 2002->2011                  |                          | 11                     | 53                       | 420           | 105         | 3x2                 | D             | 13              |
| 478553          | SENDA R X RACE   XTREM 2002->                       |                          | 13                     | 53                       | 420           | 105         | 3x2                 | D             | 13              |
| 478553          | SENDA SM X RACE   XTREM 2002->2011                  |                          | 13                     | 53                       | 420           | 105         | 3x2                 | D             | 13              |
| 467429          | SENDA R X RACE   XTREM 2002->                       |                          | 14                     | 53                       | 420           | 105         | 3x2                 | D             | 13              |
| 467429          | SENDA SM X RACE   XTREM 2002->2011                  |                          | 14                     | 53                       | 420           | 105         | 3x2                 | D             | 13              |
| 478540          | SENDA SM X RACE   XTREM 2011->   DRD   EVO   RACING |                          | 11                     | 53                       | 420           | 108         | 6                   | D             | 16              |
| 482389          | SENDA SM X RACE   XTREM 2011->   DRD   EVO   RACING |                          | 12                     | 53                       | 420           | 108         | 6                   | D             | 16              |
| 478541          | SENDA SM ->2010   R 2005->2013   DRD PRO   RACING   |                          | 11                     | 53                       | 420           | 102         | 3x2                 | D             | 10              |
| 478555          | SENDA SM ->2010   R 2005->2013   DRD PRO   RACING   |                          | 13                     | 53                       | 420           | 102         | 3x2                 | D             | 10              |
| 467432          | SENDA SM ->2010   R 2005->2013   DRD PRO   RACING   |                          | 14                     | 53                       | 420           | 102         | 3x2                 | D             | 10              |
| <b>GENERIC</b>  |   |                          |                        |                          |               |             |                     |               |                 |
| 467438          | TIGGER   KSR  |                          | 12                     | 50                       | 420           | 105         | 5                   | A             | 8               |
| <b>GILERA</b>   |   |                          |                        |                          |               |             |                     |               |                 |
| 478556          | RCR   SMT 2003->2011                                |                          | 11                     | 53                       | 420           | 105         | 3x2                 | D             | 13              |
| 478553          | RCR   SMT 2003->2011                                |                          | 13                     | 53                       | 420           | 105         | 3x2                 | D             | 13              |
| 467429          | RCR   SMT 2003->2011                                |                          | 14                     | 53                       | 420           | 105         | 3x2                 | D             | 13              |
| 478541          | RCR 2011->  |                          | 11                     | 53                       | 420           | 102         | 3x2                 | D             | 10              |
| 478555          | RCR 2011->  |                          | 13                     | 53                       | 420           | 102         | 3x2                 | D             | 10              |
| 467432          | RCR 2011->  |                          | 14                     | 53                       | 420           | 102         | 3x2                 | D             | 10              |
| 478540          | SMT 2011->  | démultiplication origine | 11                     | 53                       | 420           | 108         | 6                   | D             | 16              |
| 482389          | SMT 2011->  |                          | 12                     | 53                       | 420           | 108         | 6                   | D             | 16              |
| <b>MALAGUTI</b> |   |                          |                        |                          |               |             |                     |               |                 |
| 467437          | XSM   XTM   |                          | 11                     | 48                       | 420           | 105         | 3x2                 | A             | 13              |
| 467436          | XSM   XTM   |                          | 11                     | 50                       | 420           | 105         | 3x2                 | A             | 13              |
| 478558          | XSM   XTM   |                          | 11                     | 62                       | 420           | 105         | 3x2                 | A             | 13              |
| <b>MBK</b>      |   |                          |                        |                          |               |             |                     |               |                 |
| 482387          | X-POWER   TZR 50 1998->2003                         | démultiplication origine | 12                     | 47                       | 420           | 54          | 4                   | A             | 3               |
| 478546          | X-POWER   TZR 50 2003->                             |                          | 11                     | 60                       | 420           | 54          | 4                   | A             | 4               |
| 483520          | X-POWER   TZR 50 2003->                             | démultiplication origine | 11                     | 47                       | 420           | 54          | 4                   | A             | 4               |
| 467435          | X-LIMIT ENDURO 1997->2002                           | démultiplication origine | 12                     | 52                       | 420           | 44          | 8                   | A             | 2               |
| 467438          | X-LIMIT SM   DT50 SM 2002->2002                     |                          | 12                     | 50                       | 420           | 105         | 5                   | A             | 8               |
| 467437          | X-LIMIT SM ENDURO   DT50 SM ENDURO 2003->           |                          | 11                     | 48                       | 420           | 105         | 3x2                 | A             | 13              |
| 467436          | X-LIMIT SM ENDURO   DT50 SM ENDURO 2003->           |                          | 11                     | 50                       | 420           | 105         | 3x2                 | A             | 13              |
| 478558          | X-LIMIT SM ENDURO   DT50 SM ENDURO 2003->           |                          | 11                     | 62                       | 420           | 105         | 3x2                 | A             | 13              |

**INFO +**

 Les schémas des couronnes et pignons se trouvent à partir de la **page 245**.

|                |   |                          | Nombre de dents pignon | Nombre de dents couronne | Pas de chaîne | Ø intérieur | Nombre de fixations | Schéma pignon | Schéma couronne |
|----------------|---|--------------------------|------------------------|--------------------------|---------------|-------------|---------------------|---------------|-----------------|
| <b>PEUGEOT</b> |   |                          |                        |                          |               |             |                     |               |                 |
| 467441         | XR6 2001->  | démultiplication origine | 11                     | 52                       | 420           | 108         | 6                   | A             | 16              |
| 480750         | XR7   NK7   |                          | 11                     | 52                       | 420           | 62          | 5                   | A             | 17              |
| 478557         | XR7   NK7   |                          | 11                     | 60                       | 420           | 62          | 5                   | A             | 17              |
| 480750         | XPS SM 2005->2008   XP7 SM                            |                          | 11                     | 52                       | 420           | 62          | 5                   | A             | 17              |
| 478557         | XPS SM 2005->2008   XP7 SM                            |                          | 11                     | 60                       | 420           | 62          | 5                   | A             | 17              |
| 467442         | XP6 SM ENDURO   XPS SM ENDURO 2002->2011   XP7 ENDURO |                          | 12                     | 52                       | 420           | 105         | 3x2                 | A             | 13              |
| 467446         | XP6 SM ENDURO   XPS SM ENDURO 2002->2011   XP7 ENDURO |                          | 11                     | 52                       | 420           | 105         | 3x2                 | A             | 13              |
| 490505         | XPS STREET EVO  |                          | 11                     | 52                       | 420           | 62          | 5                   | A             | 17              |
| <b>RIEJU</b>   |   |                          |                        |                          |               |             |                     |               |                 |
| 468089         | RS2 MATRIX   NAKED 2003->                             |                          | 11                     | 47                       | 420           | 55          | 3                   | A             | 15              |
| 468088         | RS2 MATRIX   NAKED 2003->                             |                          | 13                     | 47                       | 420           | 55          | 3                   | A             | 15              |
| 467442         | RS3   |                          | 12                     | 52                       | 420           | 105         | 3x2                 | A             | 13              |
| 467446         | RS3   |                          | 11                     | 52                       | 420           | 105         | 3x2                 | A             | 13              |
| 467444         | RIEJU SMX MXR 2002   RR SPIKE 1999->2002              | démultiplication origine | 12                     | 48                       | 420           | 80          | 6                   | A             | 14              |
| 467442         | MRX   SMX 2003->2008   TANGO 2007->                   |                          | 12                     | 52                       | 420           | 105         | 3x2                 | A             | 13              |
| 467446         | MRX   SMX 2003->2008   TANGO 2007->                   |                          | 11                     | 52                       | 420           | 105         | 3x2                 | A             | 13              |
| 467442         | MRT 2009->  |                          | 12                     | 52                       | 420           | 105         | 3x2                 | A             | 13              |
| 467446         | MRT 2009->  |                          | 11                     | 52                       | 420           | 105         | 3x2                 | A             | 13              |
| 490505         | MRT SM 2011->2011                                     |                          | 11                     | 52                       | 420           | 62          | 5                   | A             | 17              |
| <b>SHERCO</b>  |   |                          |                        |                          |               |             |                     |               |                 |
| 487528         | SM ENDURO 2002->                                      | démultiplication origine | 12                     | 56                       | 428           | 110         | 3x2                 | B             | 5               |
| <b>SUZUKI</b>  |   |                          |                        |                          |               |             |                     |               |                 |
| 467447         | SMX 2001->2003   RMX 1996->2003                       | démultiplication origine | 12                     | 50                       | 420           | 110         | 3x2                 | H             | 5               |
| <b>TORN</b>    |   |                          |                        |                          |               |             |                     |               |                 |
| 467438         | X   Ride 2006->                                       |                          | 12                     | 50                       | 420           | 105         | 5                   | A             | 8               |
| <b>YAMAHA</b>  |   |                          |                        |                          |               |             |                     |               |                 |
|                | voir MBK  |                          |                        |                          |               |             |                     |               |                 |
| <b>TEKNIX</b>  |   |                          |                        |                          |               |             |                     |               |                 |
|                | Original Quality Control                              |                          |                        |                          |               |             |                     |               |                 |
|                |   |                          | Nombre de dents pignon | Nombre de dents couronne | Pas de chaîne | Ø intérieur | Nombre de fixations | Schéma pignon | Schéma couronne |
| <b>APRILIA</b> |   |                          |                        |                          |               |             |                     |               |                 |
| 455167         | RS50 1999->2005   TUONO                               |                          | 12                     | 47                       | 420           | 102         | 5                   | A             | 7               |
| 486688         | RS50 2006->2010                                       |                          | 12                     | 53                       | 420           | 108         | 6                   | D             | 16              |
| 486688         | RS4   |                          | 12                     | 53                       | 420           | 108         | 6                   | D             | 16              |
| 455172         | RX50 1995->2006                                       |                          | 12                     | 52                       | 420           | 105         | 5                   | A             | 8               |
| 455416         | RX50 2006->   |                          | 14                     | 53                       | 420           | 105         | 3x2                 | D             | 13              |
| 455416         | SX50 2006->2011                                       |                          | 14                     | 53                       | 420           | 105         | 3x2                 | D             | 13              |
| 486688         | SX50 2011->   |                          | 12                     | 53                       | 420           | 108         | 6                   | D             | 16              |
| 455172         | MX50 2003->2005                                       |                          | 12                     | 52                       | 420           | 105         | 5                   | A             | 8               |

# KIT CHAÎNE / CHAIN KIT



## INFO +

Les schémas des couronnes et pignons se trouvent à partir de la **page 245**.



|                |   |                          | Nombre de dents pignon | Nombre de dents couronne | Pas de chaîne | Ø intérieur | Nombre de fixations | Schéma pignon | Schéma couronne |
|----------------|---|--------------------------|------------------------|--------------------------|---------------|-------------|---------------------|---------------|-----------------|
| <b>BETA</b>    |   |                          |                        |                          |               |             |                     |               |                 |
| 455176         | 50 RR 2002->2005                                      | démultiplication origine | 12                     | 52                       | 420           | 100         | 3x2                 | A             | 19              |
| <b>DERBI</b>   |   |                          |                        |                          |               |             |                     |               |                 |
| 486688         | GPR NUDE   RACING 2004->                              |                          | 12                     | 53                       | 420           | 108         | 6                   | D             | 16              |
| 455171         | SEND A R/SM 1997->1999 (couronne incurvée)            | démultiplication origine | 12                     | 53                       | 420           | 53          | 4                   | C             | 11              |
| 455416         | SEND A R X RACE   XTREM 2002->2016                    |                          | 14                     | 53                       | 420           | 105         | 3x2                 | D             | 13              |
| 455416         | SEND A SM X RACE   XTREM 2002->2011                   |                          | 14                     | 53                       | 420           | 105         | 3x2                 | D             | 13              |
| 486688         | SEND A SM X RACE   XTREM 2011->   DRD   EVO           |                          | 12                     | 53                       | 420           | 108         | 6                   | D             | 16              |
| <b>GENERIC</b> |   |                          |                        |                          |               |             |                     |               |                 |
| 455172         | TIGGER   KSR  |                          | 12                     | 52                       | 420           | 105         | 5                   | A             | 8               |
| <b>GILERA</b>  |   |                          |                        |                          |               |             |                     |               |                 |
| 455170         | RCR   SMT 2003->2011                                  |                          | 13                     | 53                       | 420           | 105         | 3x2                 | D             | 13              |
| 455416         | RCR   SMT 2003->2011                                  |                          | 14                     | 53                       | 420           | 105         | 3x2                 | D             | 13              |
| 486688         | SMT 2011->  |                          | 12                     | 53                       | 420           | 108         | 6                   | D             | 16              |
|                | MALAGUTI  |                          |                        |                          |               |             |                     |               |                 |
| 455174         | XSM   XTM   |                          | 12                     | 52                       | 420           | 105         | 3x2                 | A             | 13              |
| 455175         | XSM   XTM   |                          | 13                     | 52                       | 420           | 100         | 3x2                 | A             | 13              |
| <b>MBK</b>     |   |                          |                        |                          |               |             |                     |               |                 |
| 466577         | X-LIMIT SM ENDURO   DT50 SM ENDURO 2003->             | démultiplication origine | 11                     | 48                       | 420           | 105         | 3x2                 | A             | 13              |
| 455172         | X-LIMIT SM   DT50 SM 2002->2002                       |                          | 12                     | 52                       | 420           | 105         | 5                   | A             | 8               |
| 455178         | X-POWER   TZR 50 1998->2003                           | démultiplication origine | 12                     | 47                       | 420           | 54          | 4                   | A             | 3               |
| <b>PEUGEOT</b> |   |                          |                        |                          |               |             |                     |               |                 |
| 455176         | XP6 1998->  | démultiplication origine | 12                     | 52                       | 420           | 100         | 3x2                 | A             | 19              |
| 455179         | XR6 2001->  | démultiplication origine | 12                     | 52                       | 420           | 108         | 6                   | A             | 16              |
| 455175         | XP6 SM ENDURO   XPS SM ENDURO 2002->2011   XP7 ENDURO |                          | 13                     | 52                       | 420           | 100         | 3x2                 | A             | 13              |
| 455174         | XP6 SM ENDURO   XPS SM ENDURO 2002->2011   XP7 ENDURO |                          | 12                     | 52                       | 420           | 105         | 3x2                 | A             | 13              |
| 486687         | XP7 SM   XR7   NK7   XPS SM 2005->2008                |                          | 11                     | 52                       | 420           | 62          | 5                   | A             | 17              |
| <b>RIEJU</b>   |   |                          |                        |                          |               |             |                     |               |                 |
| 455174         | RS3   |                          | 12                     | 52                       | 420           | 105         | 3x2                 | A             | 13              |
| 455174         | RS3   |                          | 11                     | 52                       | 420           | 105         | 3x2                 | A             | 13              |
| 455174         | MRX   SMX 2003->2008   TANGO 2007->                   |                          | 12                     | 52                       | 420           | 105         | 3x2                 | A             | 13              |
| 455174         | MRX   SMX 2003->2008   TANGO 2007->                   |                          | 11                     | 52                       | 420           | 105         | 3x2                 | A             | 13              |
| 455174         | MRT 2009->  |                          | 12                     | 52                       | 420           | 105         | 3x2                 | A             | 13              |
| 455174         | MRT 2009->  |                          | 11                     | 52                       | 420           | 105         | 3x2                 | A             | 13              |
| <b>TORN</b>    |   |                          |                        |                          |               |             |                     |               |                 |
| 455172         | X   Ride 2006->                                       |                          | 12                     | 52                       | 420           | 105         | 5                   | A             | 8               |
| <b>YAMAHA</b>  |   |                          |                        |                          |               |             |                     |               |                 |

voir MBK

**INFO +**

 Les schémas des couronnes et pignons se trouvent à partir de la **page 245**.

|                 |   | Nombre de dents pignon | Nombre de dents couronne | Pas de chaîne | Ø intérieur | Nombre de fixations | Schéma pignon | Schéma couronne | Couleur |
|-----------------|---|------------------------|--------------------------|---------------|-------------|---------------------|---------------|-----------------|---------|
| <b>APRILIA</b>  |   |                        |                          |               |             |                     |               |                 |         |
| 492591          | RS50 2006->2010                                       | 14                     | 53                       | 420           | 108         | 6                   | D             | 16              | rouge   |
| 492591          | RS50 2006->2010                                       | 14                     | 53                       | 420           | 108         | 6                   | D             | 16              | rouge   |
| 492591          | RS4   | 14                     | 53                       | 420           | 108         | 6                   | D             | 16              | rouge   |
| 491211          | RX50 2006->   | 14                     | 53                       | 420           | 105         | 3x2                 | D             | 13              | or      |
| 491214          | RX50 2006->   | 14                     | 53                       | 420           | 105         | 3x2                 | D             | 13              | rouge   |
| 491211          | SX50 2006->2011                                       | 14                     | 53                       | 420           | 105         | 3x2                 | D             | 13              | or      |
| 491214          | SX50 2006->2011                                       | 14                     | 53                       | 420           | 105         | 3x2                 | D             | 13              | rouge   |
| 492591          | SX50 2011->   | 14                     | 53                       | 420           | 108         | 6                   | D             | 16              | rouge   |
| <b>DERBI</b>    |   |                        |                          |               |             |                     |               |                 |         |
| 492591          | GPR NUDE   RACING 2004->                              | 14                     | 53                       | 420           | 108         | 6                   | D             | 16              | rouge   |
| 491211          | SENDA R X RACE   XTREM 2002->2016                     | 14                     | 53                       | 420           | 105         | 3x2                 | D             | 13              | or      |
| 491214          | SENDA R X RACE   XTREM 2002->2016                     | 14                     | 53                       | 420           | 105         | 3x2                 | D             | 13              | rouge   |
| 491211          | SENDA SM X RACE   XTREM 2002->2011                    | 14                     | 53                       | 420           | 105         | 3x2                 | D             | 13              | or      |
| 491214          | SENDA SM X RACE   XTREM 2002->2011                    | 14                     | 53                       | 420           | 105         | 3x2                 | D             | 13              | rouge   |
| 492591          | SENDA SM X RACE   XTREM 2011->   DRD   EVO            | 14                     | 53                       | 420           | 108         | 6                   | D             | 16              | rouge   |
| <b>GILERA</b>   |   |                        |                          |               |             |                     |               |                 |         |
| 491211          | RCR   SMT 2003->2011                                  | 14                     | 53                       | 420           | 105         | 3x2                 | D             | 13              | or      |
| 491214          | RCR   SMT 2003->2011                                  | 14                     | 53                       | 420           | 105         | 3x2                 | D             | 13              | rouge   |
| 492591          | SMT 2011->  | 14                     | 53                       | 420           | 108         | 6                   | D             | 16              | rouge   |
| <b>MALAGUTI</b> |   |                        |                          |               |             |                     |               |                 |         |
| 491213          | XSM   XTM   | 13                     | 53                       | 420           | 105         | 3x2                 | A             | 13              | or      |
| 491215          | XSM   XTM   | 13                     | 53                       | 420           | 105         | 3x2                 | A             | 13              | rouge   |
| <b>MBK</b>      |   |                        |                          |               |             |                     |               |                 |         |
| 491213          | X-LIMIT SM ENDURO   DT50 SM ENDURO 2003->             | 13                     | 53                       | 420           | 105         | 3x2                 | A             | 13              | or      |
| 491215          | X-LIMIT SM ENDURO   DT50 SM ENDURO 2003->             | 13                     | 53                       | 420           | 105         | 3x2                 | A             | 13              | rouge   |
| <b>PEUGEOT</b>  |   |                        |                          |               |             |                     |               |                 |         |
| 491213          | XP6 SM ENDURO   XPS SM ENDURO 2002->2011   XP7 ENDURO | 13                     | 53                       | 420           | 105         | 3x2                 | A             | 13              | or      |
| 491215          | XP6 SM ENDURO   XPS SM ENDURO 2002->2011   XP7 ENDURO | 13                     | 53                       | 420           | 105         | 3x2                 | A             | 13              | rouge   |
| <b>RIEJU</b>    |   |                        |                          |               |             |                     |               |                 |         |
| 491213          | MRT   RS3   | 13                     | 53                       | 420           | 105         | 3x2                 | A             | 13              | or      |
| 491215          | MRT   RS3   | 13                     | 53                       | 420           | 105         | 3x2                 | A             | 13              | rouge   |
| 491213          | RS3   | 13                     | 53                       | 420           | 105         | 3x2                 | A             | 13              | or      |
| 491215          | RS3   | 13                     | 53                       | 420           | 105         | 3x2                 | A             | 13              | rouge   |
| 491213          | MRX   SMX 2003->2008   TANGO 2007->                   | 13                     | 53                       | 420           | 105         | 3x2                 | A             | 13              | or      |
| 491215          | MRX   SMX 2003->2008   TANGO 2007->                   | 13                     | 53                       | 420           | 105         | 3x2                 | A             | 13              | rouge   |
| 491213          | MRT 2009->  | 13                     | 53                       | 420           | 105         | 3x2                 | A             | 13              | or      |
| 491215          | MRT 2009->  | 13                     | 53                       | 420           | 105         | 3x2                 | A             | 13              | rouge   |
| <b>YAMAHA</b>   |   |                        |                          |               |             |                     |               |                 |         |

voir MBK

# KIT CHAINE / CHAIN KIT

MOTEUR

## PIGNON

INFO +

Retrouvez les correspondances par engin et par marque à partir de la page 249.

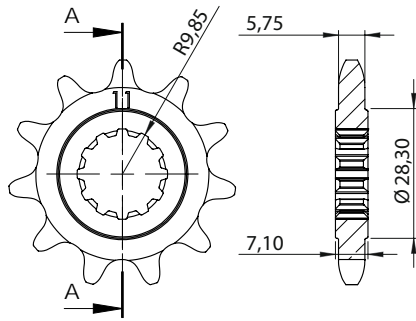

**A**

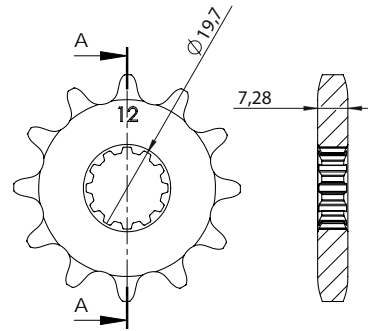

**B**

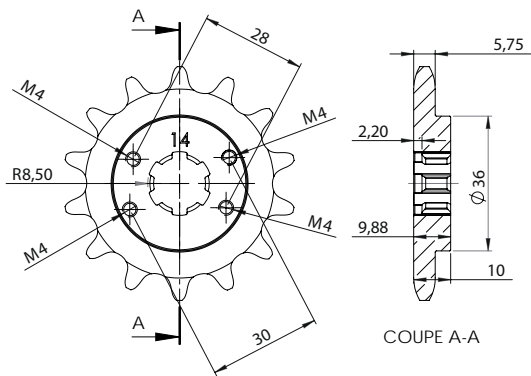

**C**

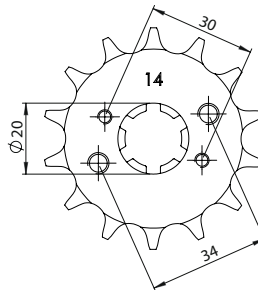

**D**

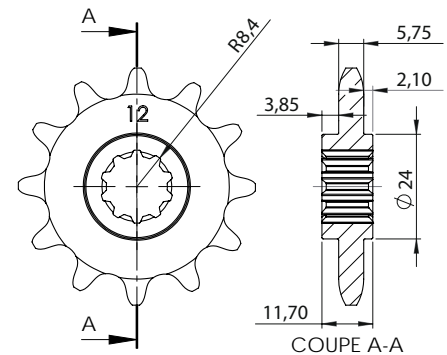

**F**

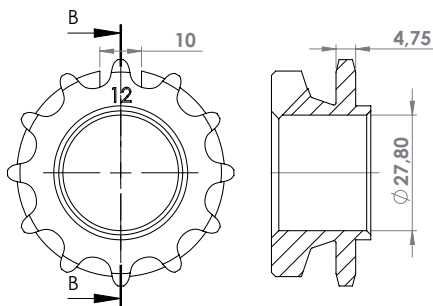

**G**

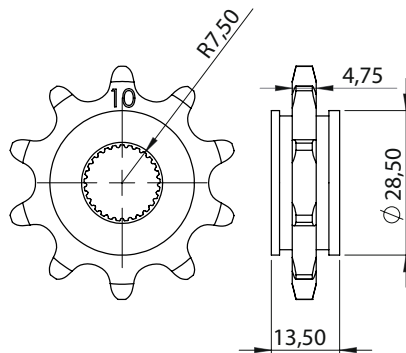

**H**

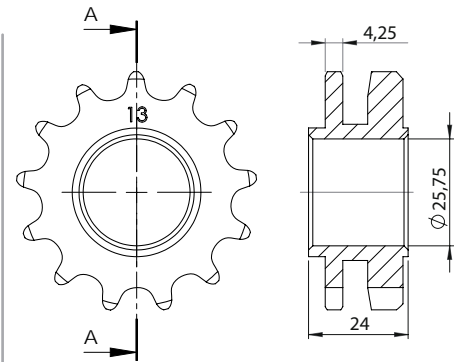

**I**

## COURONNE

**INFO +**  
Type de perçage

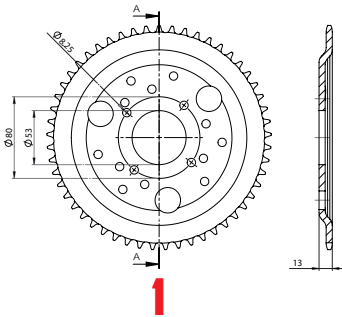
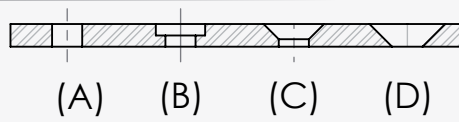

**1**

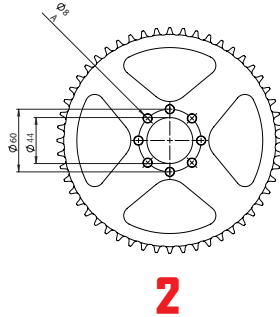

**2**

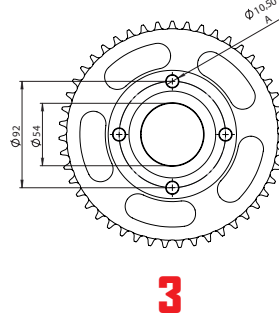

**3**

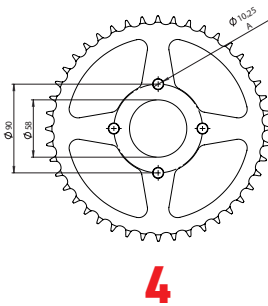

**4**

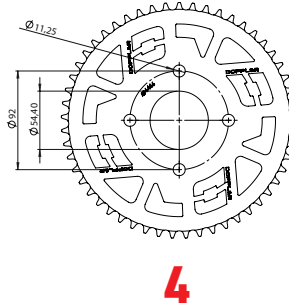

**4**

**DOPPLER**

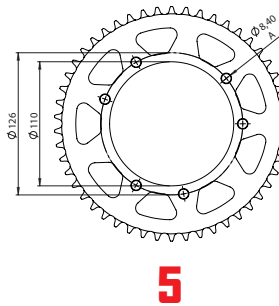

**5**

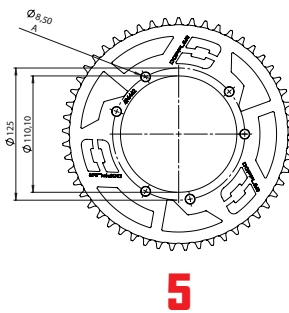

**5**

**DOPPLER**

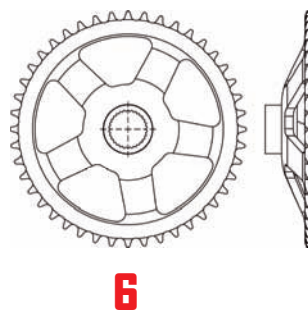

**6**

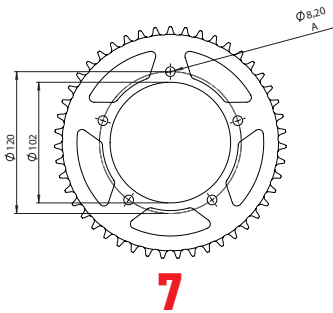

**7**

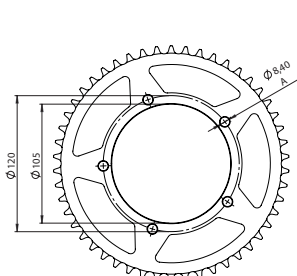

**8**

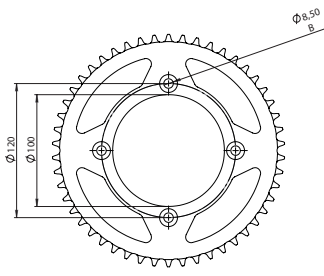

**9**

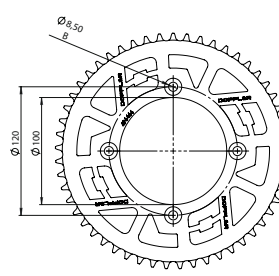

**9**

**DOPPLER**



# KIT CHAÎNE / CHAIN KIT

## COURONNE

INFO +  
Type de perçage

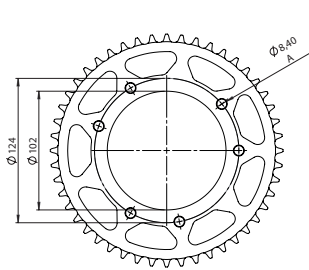
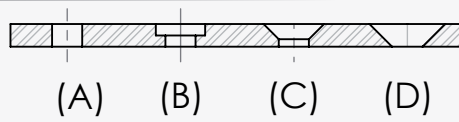

10

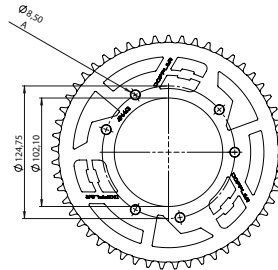

10

**DOPPLER**

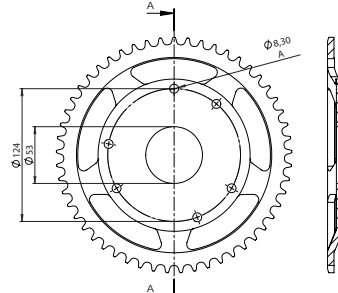

11

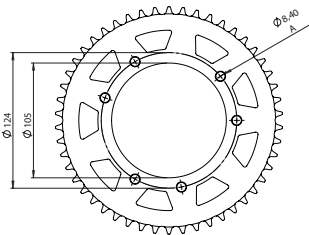

13

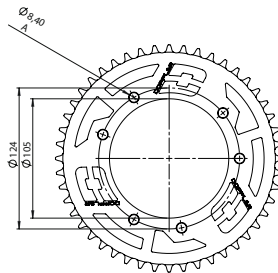

13

**DOPPLER**

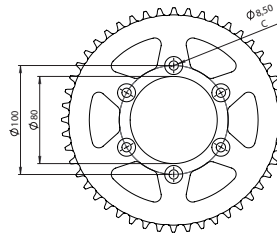

14

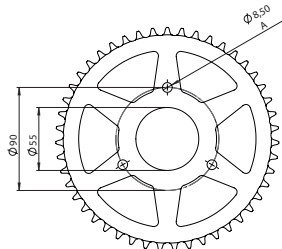

15

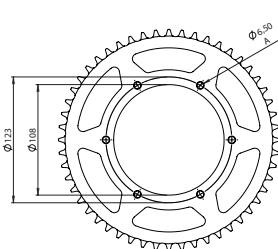

16

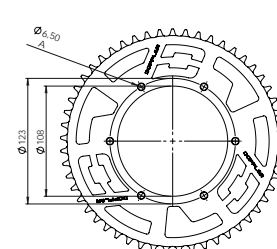

16

**DOPPLER**

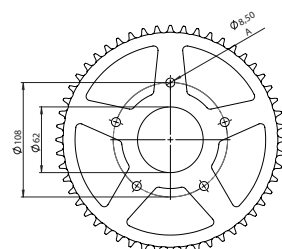

17

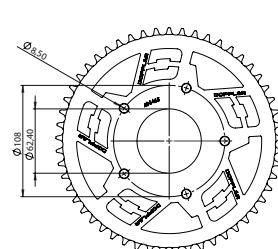

17

**DOPPLER**

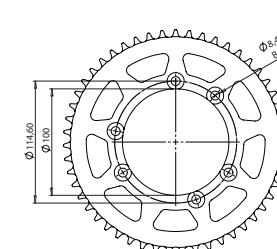

19

MOTEUR

## COURONNE

INFO +  
Type de perçage



(A) (B) (C) (D)

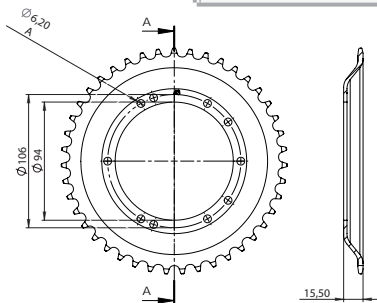

20

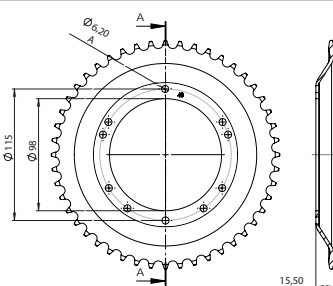

21

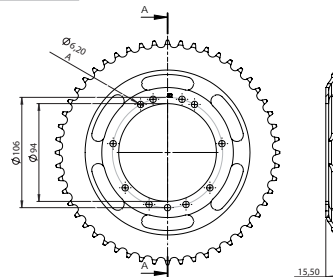

22

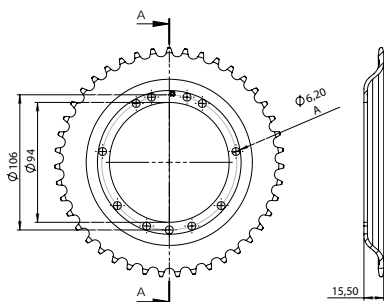

23

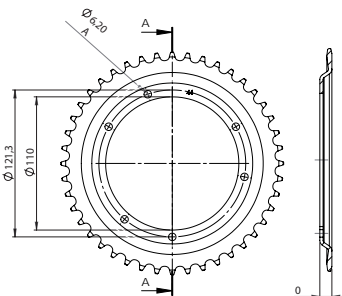

24

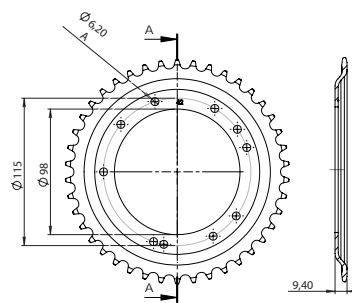

25

COUPE A-A

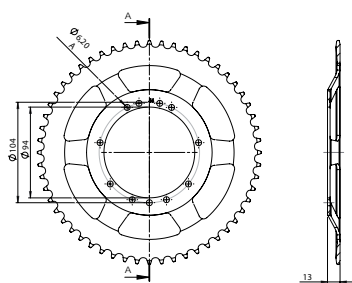

26

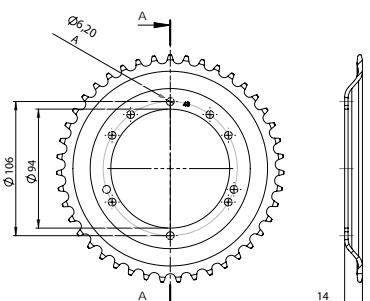

27

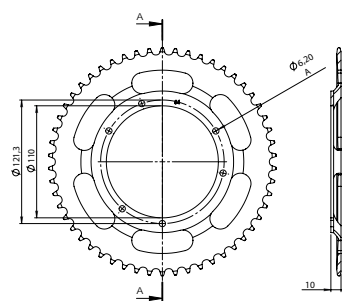

28

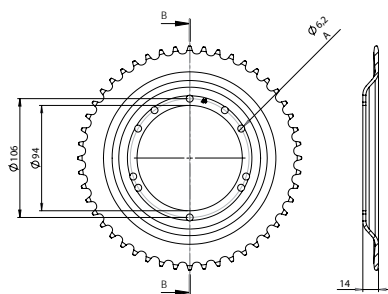

29

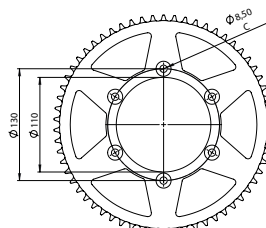

30



### INFO +

Retrouvez les schémas des pignons à partir de la **page 249**.



bleu



orange



rouge



vert

| AMG                     |                 |               |        |        |        |        |        |        |
|-------------------------|-----------------|---------------|--------|--------|--------|--------|--------|--------|
|                         | Nombre de dents | Pas de chaîne | Schéma | TEKNIX | TUN'R  |        |        |        |
|                         |                 |               |        |        | bleu   | orange | rouge  | vert   |
|                         | 11              | 420           | A      | 481752 |        |        |        |        |
|                         | 12              | 420           | A      | 289500 | 496740 | 496739 | 496737 | 496738 |
|                         | 13              | 420           | A      | 289514 | 496714 | 496715 | 496712 | 496713 |
|                         | 14              | 420           | A      | 282725 | 496710 | 496711 | 496708 | 496709 |
|                         | 15              | 420           | A      | 450037 | 496706 | 496707 | 496704 | 496705 |
|                         | 12              | 428           | B      | 490506 |        |        |        |        |
|                         | 13              | 428           | B      | 490507 |        |        |        |        |
|                         | 14              | 428           | B      | 490508 |        |        |        |        |
| GILERA                  |                 |               |        |        |        |        |        |        |
| GSM ->2000              | 12              | 420           | F      | 479418 |        |        |        |        |
| GSM ->2000              | 13              | 420           | F      | 479419 |        |        |        |        |
| GSM ->2000              | 14              | 420           | F      | 479420 |        |        |        |        |
| DERBI                   |                 |               |        |        |        |        |        |        |
| SENDA/GPR/GSM 1999->    | 11              | 420           | C      | 475182 |        |        |        |        |
| SENDA/GPR/GSM 1999->    | 12              | 420           | C      | 449872 | 496726 | 496727 | 496720 | 496724 |
| SENDA/GPR/GSM 1999->    | 13              | 420           | C      | 449873 | 496725 | 496729 | 496721 | 496728 |
| SENDA/GPR/GSM 1999->    | 14              | 420           | C      | 449874 | 496733 | 496735 | 496722 | 496730 |
| SENDA/GPR/GSM 1999->    | 14              | 428           | C      | 497377 |        |        |        |        |
| SENDA/GPR/GSM 1999->    | 15              | 420           | C      | 475183 | 496734 | 496736 | 496723 | 496732 |
| SENDA/GPR/GSM 1999->    | 15              | 428           | C      | 497378 |        |        |        |        |
| SENDA/GPR/PHENIX ->1999 | 12              | 420           | C      | 247584 |        |        |        |        |
| SENDA/GPR/PHENIX ->1999 | 13              | 420           | C      | 220365 |        |        |        |        |
| SENDA/GPR/PHENIX ->1999 | 14              | 420           | C      | 220357 |        |        |        |        |
| SENDA/GPR/PHENIX ->1999 | 15              | 420           | C      | 369053 |        |        |        |        |



## ACCESSOIRE

- 485296** clic maintien pignon sortie boîte AM6 Ø20
- 484861** plaquette maintien pignon sortie boîte DERBI EURO 2 et 3
- 490398** plaquette maintien pignon sortie boîte DERBI EURO 2 et 3 spécifique 11 dents



485296

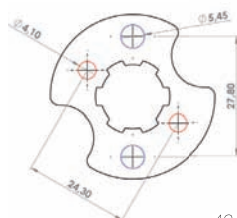

484861

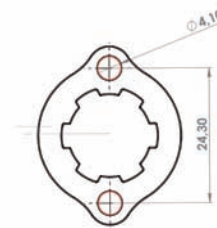

490398



## PEUGEOT

|     |                  | Nombre de dents | Schéma |
|-----|------------------|-----------------|--------|
| 855 | 103 SP/VOGUE/MVL | 11              | G      |
| 857 |                  | 12              | G      |
| 858 |                  | 13              | G      |
| 860 | 103 SPX/RCX      | 10              | H      |
| 861 |                  | 11              | H      |
| 862 |                  | 12              | H      |

## MBK

|      |    |    |   |
|------|----|----|---|
| 4259 | 51 | 11 | I |
| 4260 |    | 12 | I |
| 4261 |    | 13 | I |



G



H



I



## ACCESSOIRE

- 485297** clip maintien pignon 103 SPX/RCX Ø13





## INFO +

Retrouvez les schémas des couronnes à partir de la **page 246**.



|                 |  | Nombre de dents | Pas de chaîne | Ø intérieur (mm) | Nombre de trous de fixation | Schéma | Couleur |
|-----------------|--|-----------------|---------------|------------------|-----------------------------|--------|---------|
| <b>APRILIA</b>  |  |                 |               |                  |                             |        |         |
| <b>495673</b>   | RS50 2006->2010                            | 53              | 420           | 108              | 6                           | 16     | or      |
| <b>496463</b>   | RS50 2006->2010                            | 53              | 420           | 108              | 6                           | 16     | rouge   |
| <b>491209</b>   | RX50 2006->                                | 53              | 420           | 105              | 3x2                         | 13     | or      |
| <b>491212</b>   | RX50 2006->                                | 53              | 420           | 105              | 3x2                         | 13     | rouge   |
| <b>491209</b>   | SX50 2006->2011                            | 53              | 420           | 105              | 3x2                         | 13     | or      |
| <b>491212</b>   | SX50 2006->2011                            | 53              | 420           | 105              | 3x2                         | 13     | rouge   |
| <b>495673</b>   | RS4  | 53              | 420           | 108              | 6                           | 16     | or      |
| <b>496463</b>   | RS4  | 53              | 420           | 108              | 6                           | 16     | rouge   |
| <b>495673</b>   | SX50 2011->                                | 53              | 420           | 102              | 3x2                         | 16     | or      |
| <b>496463</b>   | SX50 2011->                                | 53              | 420           | 102              | 3x2                         | 16     | rouge   |
| <b>BETA</b>     |  |                 |               |                  |                             |        |         |
| <b>496464</b>   | 50 RR 2005->                               | 53              | 428           | 100              | 4                           | 9      | rouge   |
| <b>496464</b>   | 50 RR SM 2005->                            | 53              | 428           | 100              | 4                           | 9      | rouge   |
| <b>496464</b>   | 50 RR FACTORY 2005->                       | 53              | 428           | 100              | 4                           | 9      | rouge   |
| <b>DERBI</b>    |  |                 |               |                  |                             |        |         |
| <b>495673</b>   | GPR NUDE   RACING 2004->                   | 53              | 420           | 108              | 6                           | 16     | or      |
| <b>496463</b>   | GPR NUDE   RACING 2004->                   | 53              | 420           | 108              | 6                           | 16     | rouge   |
| <b>491209</b>   | SENDA R X RACE   XTREM 2002->              | 53              | 420           | 105              | 3x2                         | 13     | or      |
| <b>491212</b>   | SENDA R X RACE   XTREM 2002->              | 53              | 420           | 105              | 3x2                         | 13     | rouge   |
| <b>491209</b>   | SENDA SM X RACE   XTREM 2002->2011         | 53              | 420           | 105              | 3x2                         | 13     | or      |
| <b>491212</b>   | SENDA SM X RACE   XTREM 2002->2011         | 53              | 420           | 105              | 3x2                         | 13     | rouge   |
| <b>495673</b>   | SENDA SM X RACE   XTREM 2011->   DRD   EVO | 53              | 420           | 108              | 6                           | 16     | or      |
| <b>496463</b>   | SENDA SM X RACE   XTREM 2011->   DRD   EVO | 53              | 420           | 108              | 6                           | 16     | rouge   |
| <b>GILERA</b>   |  |                 |               |                  |                             |        |         |
| <b>491209</b>   | RCR   SMT 2003->2011                       | 53              | 420           | 105              | 3x2                         | 13     | or      |
| <b>491212</b>   | RCR   SMT 2003->2011                       | 53              | 420           | 105              | 3x2                         | 13     | rouge   |
| <b>495673</b>   | SMT 2011->                                 | 53              | 420           | 108              | 6                           | 16     | or      |
| <b>496463</b>   | SMT 2011->                                 | 53              | 420           | 108              | 6                           | 16     | rouge   |
| <b>MALAGUTI</b> |  |                 |               |                  |                             |        |         |
| <b>491209</b>   | XSM   XTM                                  | 53              | 420           | 105              | 3x2                         | 13     | or      |
| <b>491212</b>   | XSM   XTM                                  | 53              | 420           | 105              | 3x2                         | 13     | rouge   |

**INFO +**

 Retrouvez les schémas des couronnes à partir de la **page 246**.

|                |   | Nombre de dents | Pas de chaîne | Ø intérieur (mm) | Nombre de trous de fixation | Schéma | Couleur |
|----------------|---|-----------------|---------------|------------------|-----------------------------|--------|---------|
| <b>MBK</b>     |   |                 |               |                  |                             |        |         |
| <b>496466</b>  | X-POWER   TZR 50 2003->                               | 53              | 420           | 54               | 4                           | 4      | rouge   |
| <b>496466</b>  | X-POWER   TZR 50 2003->                               | 53              | 420           | 54               | 4                           | 4      | rouge   |
| <b>491209</b>  | X-LIMIT SM ENDURO   DT50 SM ENDURO 2003->             | 53              | 420           | 105              | 3x2                         | 13     | or      |
| <b>491212</b>  | X-LIMIT SM ENDURO   DT50 SM ENDURO 2003->             | 53              | 420           | 105              | 3x2                         | 13     | rouge   |
| <b>PEUGEOT</b> |   |                 |               |                  |                             |        |         |
| <b>495673</b>  | XR6 2001->  | 53              | 420           | 108              | 6                           | 16     | or      |
| <b>496463</b>  | XR6 2001->  | 53              | 420           | 108              | 6                           | 16     | rouge   |
| <b>496465</b>  | XR7   NK7   | 53              | 420           | 62               | 5                           | 17     | rouge   |
| <b>496465</b>  | XPS SM 2005->2008   XP7 SM                            | 53              | 420           | 62               | 5                           | 17     | rouge   |
| <b>491209</b>  | XP6 SM ENDURO   XPS SM ENDURO 2002->2011   XP7 ENDURO | 53              | 420           | 105              | 3x2                         | 13     | or      |
| <b>491212</b>  | XP6 SM ENDURO   XPS SM ENDURO 2002->2011   XP7 ENDURO | 53              | 420           | 105              | 3x2                         | 13     | rouge   |
| <b>496465</b>  | XPS STREET EVO  | 53              | 420           | 62               | 5                           | 17     | rouge   |
| <b>RIEJU</b>   |   |                 |               |                  |                             |        |         |
| <b>491209</b>  | RS3   | 53              | 420           | 105              | 3x2                         | 13     | or      |
| <b>491212</b>  | RS3   | 53              | 420           | 105              | 3x2                         | 13     | rouge   |
| <b>491209</b>  | MRX   SMX 2003->2008   TANGO 2007->                   | 53              | 420           | 105              | 3x2                         | 13     | or      |
| <b>491212</b>  | MRX   SMX 2003->2008   TANGO 2007->                   | 53              | 420           | 105              | 3x2                         | 13     | rouge   |
| <b>491209</b>  | MRT 2009->  | 53              | 420           | 105              | 3x2                         | 13     | or      |
| <b>491212</b>  | MRT 2009->  | 53              | 420           | 105              | 3x2                         | 13     | rouge   |
| <b>496465</b>  | MRT SM 2011->2011                                     | 53              | 420           | 62               | 5                           | 17     | rouge   |
| <b>SHERCO</b>  |   |                 |               |                  |                             |        |         |
| <b>496462</b>  | HERCO ENDURO  | 53              | 428           | 110              | 3x2                         | 5      | rouge   |
| <b>YAMAHA</b>  |   |                 |               |                  |                             |        |         |

Voir MBK



## INFO +

Retrouvez les schémas des couronnes à partir de la **page 246**.

Sélection  
**CGN**

|                |   | Nombre de dents | Pas de chaîne | Ø intérieur (mm) | Nombre de trous de fixation | Schéma | Couleur |
|----------------|---|-----------------|---------------|------------------|-----------------------------|--------|---------|
| <b>APRILIA</b> |   |                 |               |                  |                             |        |         |
| <b>450041</b>  | RS50 1999->2005   TUONO                     | 44              | 420           | 102              | 5                           | 7      |         |
| <b>369154</b>  | RS50 1999->2005   TUONO                     | 47              | 420           | 102              | 5                           | 7      |         |
| <b>485201</b>  | RS50 2006->2010                             | 53              | 420           | 108              | 6                           | 16     |         |
| <b>485201</b>  | RS4   | 53              | 420           | 108              | 6                           | 16     |         |
| <b>450038</b>  | RX50 2006->                                 | 48              | 420           | 105              | 3x2                         | 13     |         |
| <b>451777</b>  | RX50 2006->                                 | 52              | 420           | 105              | 3x2                         | 13     |         |
| <b>451778</b>  | RX50 2006->                                 | 53              | 420           | 105              | 3x2                         | 13     |         |
| <b>496716</b>  | RX50 2006->                                 | 53              | 420           | 105              | 3x2                         | 13     | rouge   |
| <b>496717</b>  | RX50 2006->                                 | 53              | 420           | 105              | 3x2                         | 13     | vert    |
| <b>496718</b>  | RX50 2006->                                 | 53              | 420           | 105              | 3x2                         | 13     | bleu    |
| <b>496719</b>  | RX50 2006->                                 | 53              | 420           | 105              | 3x2                         | 13     | orange  |
| <b>450038</b>  | SX50 2006->2011                             | 48              | 420           | 105              | 3x2                         | 13     |         |
| <b>451777</b>  | SX50 2006->2011                             | 52              | 420           | 105              | 3x2                         | 13     |         |
| <b>451778</b>  | SX50 2006->2011                             | 53              | 420           | 105              | 3x2                         | 13     |         |
| <b>496716</b>  | SX50 2006->2011                             | 53              | 420           | 105              | 3x2                         | 13     | rouge   |
| <b>496717</b>  | SX50 2006->2011                             | 53              | 420           | 105              | 3x2                         | 13     | vert    |
| <b>496718</b>  | SX50 2006->2011                             | 53              | 420           | 105              | 3x2                         | 13     | bleu    |
| <b>496719</b>  | SX50 2006->2011                             | 53              | 420           | 105              | 3x2                         | 13     | orange  |
| <b>485201</b>  | SX50 2011->                                 | 53              | 420           | 108              | 6                           | 16     |         |
| <b>BETA</b>    |   |                 |               |                  |                             |        |         |
| <b>495148</b>  | 50 RR 2002->2005                            | 51              | 420           | 100              | 3x2                         | 19     |         |
| <b>495149</b>  | 50 RR 2005->                                | 50              | 428           | 100              | 4                           | 9      |         |
| <b>495149</b>  | 50 RR SM 2005->                             | 50              | 428           | 100              | 4                           | 9      |         |
| <b>495149</b>  | 50 RR FACTORY 2005->                        | 50              | 428           | 100              | 4                           | 9      |         |
| <b>CPI</b>     |   |                 |               |                  |                             |        |         |
| <b>484145</b>  | 50 SM   SUPERCROSS   BLACK TIGER 2006->2009 | 52              | 420           | 110              | 6                           | 30     |         |
| <b>484145</b>  | SX 2006->2012                               | 52              | 420           | 110              | 6                           | 30     |         |
| <b>DERBI</b>   |   |                 |               |                  |                             |        |         |
| <b>485201</b>  | GPR NUDE   RACING 2004->                    | 53              | 420           | 108              | 6                           | 16     |         |
| <b>369019</b>  | DERBI SENDA 1996->1999 (incurvée)           | 53              | 420           | 53               | 4                           | 1      |         |
| <b>484143</b>  | SENDA R X RACE   XTREM 2002->2016           | 48              | 420           | 102              | 3x2                         | 13     |         |
| <b>484144</b>  | SENDA R X RACE   XTREM 2002->2016           | 52              | 420           | 102              | 3x2                         | 13     |         |
| <b>450038</b>  | SENDA R X RACE   XTREM 2002->2016           | 48              | 420           | 105              | 3x2                         | 13     |         |

**INFO +**

 Retrouvez les schémas des couronnes à partir de la **page 246**.

 Sélection  
**CGN**

|               |  | Nombre de dents | Pas de chaîne | Ø intérieur (mm) | Nombre de trous de fixation | Schéma | Couleur |
|---------------|--|-----------------|---------------|------------------|-----------------------------|--------|---------|
| <b>DERBI</b>  |  |                 |               |                  |                             |        |         |
| 451777        | SENDA R X RACE   XTREM 2002->2016          | 52              | 420           | 105              | 3x2                         | 13     |         |
| 451778        | SENDA R X RACE   XTREM 2002->2016          | 53              | 420           | 105              | 3x2                         | 13     |         |
| 496716        | SENDA R X RACE   XTREM 2002->2016          | 53              | 420           | 105              | 3x2                         | 13     | rouge   |
| 496717        | SENDA R X RACE   XTREM 2002->2016          | 53              | 420           | 105              | 3x2                         | 13     | vert    |
| 496718        | SENDA R X RACE   XTREM 2002->2016          | 53              | 420           | 105              | 3x2                         | 13     | bleu    |
| 496719        | SENDA R X RACE   XTREM 2002->2016          | 53              | 420           | 105              | 3x2                         | 13     | orange  |
| 484143        | SENDA SM X RACE   XTREM 2002->2011         | 48              | 420           | 102              | 3x2                         | 13     |         |
| 484144        | SENDA SM X RACE   XTREM 2002->2011         | 52              | 420           | 102              | 3x2                         | 13     |         |
| 450038        | SENDA SM X RACE   XTREM 2002->2011         | 48              | 420           | 105              | 3x2                         | 13     |         |
| 451777        | SENDA SM X RACE   XTREM 2002->2011         | 52              | 420           | 105              | 3x2                         | 13     |         |
| 451778        | SENDA SM X RACE   XTREM 2002->2011         | 53              | 420           | 105              | 3x2                         | 13     |         |
| 496716        | SENDA SM X RACE   XTREM 2002->2011         | 53              | 420           | 105              | 3x2                         | 13     | rouge   |
| 496717        | SENDA SM X RACE   XTREM 2002->2011         | 53              | 420           | 105              | 3x2                         | 13     | vert    |
| 496718        | SENDA SM X RACE   XTREM 2002->2011         | 53              | 420           | 105              | 3x2                         | 13     | bleu    |
| 496719        | SENDA SM X RACE   XTREM 2002->2011         | 53              | 420           | 105              | 3x2                         | 13     | orange  |
| 485201        | SENDA SM X RACE   XTREM 2011->   DRD   EVO | 53              | 420           | 108              | 6                           | 16     |         |
| <b>GILERA</b> |  |                 |               |                  |                             |        |         |
| 450038        | RCR   SMT 2003->2011                       | 48              | 420           | 105              | 3x2                         | 13     |         |
| 451777        | RCR   SMT 2003->2011                       | 52              | 420           | 105              | 3x2                         | 13     |         |
| 451778        | RCR   SMT 2003->2011                       | 53              | 420           | 105              | 3x2                         | 13     |         |
| 496716        | RCR   SMT 2003->2011                       | 53              | 420           | 105              | 3x2                         | 13     | rouge   |
| 496717        | RCR   SMT 2003->2011                       | 53              | 420           | 105              | 3x2                         | 13     | vert    |
| 496718        | RCR   SMT 2003->2011                       | 53              | 420           | 105              | 3x2                         | 13     | bleu    |
| 496719        | RCR   SMT 2003->2011                       | 53              | 420           | 105              | 3x2                         | 13     | orange  |
| 485201        | SMT 2011->                                 | 53              | 420           | 108              | 6                           | 16     |         |





## INFO +

Retrouvez les schémas des couronnes à partir de la **page 246**.

|                 |   | Nombre de dents | Pas de chaîne | Ø intérieur (mm) | Nombre de trous de fixation | Schéma | Couleur |  |
|-----------------|---|-----------------|---------------|------------------|-----------------------------|--------|---------|--|
| <b>MALAGUTI</b> |   |                 |               |                  |                             |        |         |  |
| 450038          | XSM   XTM                                 | 48              | 420           | 105              | 3x2                         | 13     |         |  |
| 451777          | XSM   XTM                                 | 52              | 420           | 105              | 3x2                         | 13     |         |  |
| 451778          | XSM   XTM                                 | 53              | 420           | 105              | 3x2                         | 13     |         |  |
| 496716          | XSM   XTM                                 | 53              | 420           | 105              | 3x2                         | 13     | rouge   |  |
| 496717          | XSM   XTM                                 | 53              | 420           | 105              | 3x2                         | 13     | vert    |  |
| 496718          | XSM   XTM                                 | 53              | 420           | 105              | 3x2                         | 13     | bleu    |  |
| 496719          | XSM   XTM                                 | 53              | 420           | 105              | 3x2                         | 13     | orange  |  |
| <b>MBK</b>      |   |                 |               |                  |                             |        |         |  |
| 449891          | X-POWER   TZR 50 1998->2003               | 44              | 420           | 54               | 4                           | 3      |         |  |
| 451775          | X-POWER   TZR 50 1998->2003               | 46              | 420           | 54               | 4                           | 3      |         |  |
| 440147          | X-POWER   TZR 50 1998->2003               | 47              | 420           | 54               | 4                           | 3      |         |  |
| 451776          | X-POWER   TZR 50 1998->2003               | 48              | 420           | 54               | 4                           | 3      |         |  |
| 450038          | X-LIMIT SM ENDURO   DT50 SM ENDURO 2003-> | 48              | 420           | 105              | 3x2                         | 13     |         |  |
| 451777          | X-LIMIT SM ENDURO   DT50 SM ENDURO 2003-> | 52              | 420           | 105              | 3x2                         | 13     |         |  |
| 451778          | X-LIMIT SM ENDURO   DT50 SM ENDURO 2003-> | 53              | 420           | 105              | 3x2                         | 13     |         |  |
| 496716          | X-LIMIT SM ENDURO   DT50 SM ENDURO 2003-> | 53              | 420           | 105              | 3x2                         | 13     | rouge   |  |
| 496717          | X-LIMIT SM ENDURO   DT50 SM ENDURO 2003-> | 53              | 420           | 105              | 3x2                         | 13     | vert    |  |
| 496718          | X-LIMIT SM ENDURO   DT50 SM ENDURO 2003-> | 53              | 420           | 105              | 3x2                         | 13     | bleu    |  |
| 496719          | X-LIMIT SM ENDURO   DT50 SM ENDURO 2003-> | 53              | 420           | 105              | 3x2                         | 13     | orange  |  |

**INFO +**

 Retrouvez les schémas des couronnes à partir de la **page 246**.

|                |   | Nombre de dents | Pas de chaîne | Ø intérieur (mm) | Nombre de trous de fixation | Schéma | Couleur |  |
|----------------|---|-----------------|---------------|------------------|-----------------------------|--------|---------|--|
| <b>PEUGEOT</b> |   |                 |               |                  |                             |        |         |  |
| <b>482877</b>  | XR7   NK7   | 52              | 420           | 62               | 5                           | 17     |         |  |
| <b>484142</b>  | XR7   NK7   | 48              | 420           | 62               | 5                           | 17     |         |  |
| <b>482877</b>  | XPS SM 2005->2008   XP7 SM                            | 52              | 420           | 62               | 5                           | 17     |         |  |
| <b>484142</b>  | XPS SM 2005->2008   XP7 SM                            | 48              | 420           | 62               | 5                           | 17     |         |  |
| <b>450044</b>  | XP6 SM ENDURO   XPS SM ENDURO 2002->2011   XP7 ENDURO | 52              | 420           | 100              | 3x2                         | 13     |         |  |
| <b>450038</b>  | XP6 SM ENDURO   XPS SM ENDURO 2002->2011   XP7 ENDURO | 48              | 420           | 105              | 3x2                         | 13     |         |  |
| <b>451777</b>  | XP6 SM ENDURO   XPS SM ENDURO 2002->2011   XP7 ENDURO | 52              | 420           | 105              | 3x2                         | 13     |         |  |
| <b>451778</b>  | XP6 SM ENDURO   XPS SM ENDURO 2002->2011   XP7 ENDURO | 53              | 420           | 105              | 3x2                         | 13     |         |  |
| <b>496716</b>  | XP6 SM ENDURO   XPS SM ENDURO 2002->2011   XP7 ENDURO | 53              | 420           | 105              | 3x2                         | 13     | rouge   |  |
| <b>496717</b>  | XP6 SM ENDURO   XPS SM ENDURO 2002->2011   XP7 ENDURO | 53              | 420           | 105              | 3x2                         | 13     | vert    |  |
| <b>496718</b>  | XP6 SM ENDURO   XPS SM ENDURO 2002->2011   XP7 ENDURO | 53              | 420           | 105              | 3x2                         | 13     | bleu    |  |
| <b>496719</b>  | XP6 SM ENDURO   XPS SM ENDURO 2002->2011   XP7 ENDURO | 53              | 420           | 105              | 3x2                         | 13     | orange  |  |
| <b>482877</b>  | XPS STREET EVO  | 52              | 420           | 62               | 5                           | 17     |         |  |
| <b>484142</b>  | XPS STREET EVO  | 48              | 420           | 62               | 5                           | 17     |         |  |



## INFO +

Retrouvez les schémas des couronnes à partir de la **page 246**.

|               |                                     | Nombre de dents | Pas de chaîne | Ø intérieur (mm) | Nombre de trous de fixation | Schéma | Couleur |  |
|---------------|-------------------------------------|-----------------|---------------|------------------|-----------------------------|--------|---------|--|
| <b>RIEJU</b>  |                                     |                 |               |                  |                             |        |         |  |
| 450038        | RS3                                 | 48              | 420           | 105              | 3x2                         | 13     |         |  |
| 451777        | RS3                                 | 52              | 420           | 105              | 3x2                         | 13     |         |  |
| 451778        | RS3                                 | 53              | 420           | 105              | 3x2                         | 13     |         |  |
| 496716        | RS3                                 | 53              | 420           | 105              | 3x2                         | 13     | rouge   |  |
| 496717        | RS3                                 | 53              | 420           | 105              | 3x2                         | 13     | vert    |  |
| 496718        | RS3                                 | 53              | 420           | 105              | 3x2                         | 13     | bleu    |  |
| 496719        | RS3                                 | 53              | 420           | 105              | 3x2                         | 13     | orange  |  |
| 450038        | MRX   SMX 2003->2008   TANGO 2007-> | 48              | 420           | 105              | 3x2                         | 13     |         |  |
| 451777        | MRX   SMX 2003->2008   TANGO 2007-> | 52              | 420           | 105              | 3x2                         | 13     |         |  |
| 451778        | MRX   SMX 2003->2008   TANGO 2007-> | 53              | 420           | 105              | 3x2                         | 13     |         |  |
| 496716        | MRX   SMX 2003->2008   TANGO 2007-> | 53              | 420           | 105              | 3x2                         | 13     | rouge   |  |
| 496717        | MRX   SMX 2003->2008   TANGO 2007-> | 53              | 420           | 105              | 3x2                         | 13     | vert    |  |
| 496718        | MRX   SMX 2003->2008   TANGO 2007-> | 53              | 420           | 105              | 3x2                         | 13     | bleu    |  |
| 496719        | MRX   SMX 2003->2008   TANGO 2007-> | 53              | 420           | 105              | 3x2                         | 13     | orange  |  |
| 450038        | MRT 2009->                          | 48              | 420           | 105              | 3x2                         | 13     |         |  |
| 451777        | MRT 2009->                          | 52              | 420           | 105              | 3x2                         | 13     |         |  |
| 451778        | MRT 2009->                          | 53              | 420           | 105              | 3x2                         | 13     |         |  |
| 496716        | MRT 2009->                          | 53              | 420           | 105              | 3x2                         | 13     | rouge   |  |
| 496717        | MRT 2009->                          | 53              | 420           | 105              | 3x2                         | 13     | vert    |  |
| 496718        | MRT 2009->                          | 53              | 420           | 105              | 3x2                         | 13     | bleu    |  |
| 496719        | MRT 2009->                          | 53              | 420           | 105              | 3x2                         | 13     | orange  |  |
| 482877        | MRT SM 2011->2011                   | 52              | 420           | 62               | 5                           | 17     |         |  |
| <b>SHERCO</b> |                                     |                 |               |                  |                             |        |         |  |
| 495147        | ENDURO   SM 2003 ->                 | 56              | 428           | 110              | 3x2                         | 5      |         |  |
| <b>YAMAHA</b> |                                     |                 |               |                  |                             |        |         |  |
| Voir MBK      |                                     |                 |               |                  |                             |        |         |  |

 Sélection  
**CGN**

# COURONNE / CHAIN RING

**INFO +**

 Retrouvez les schémas des couronnes à partir de la **page 246**.

|                |                        | Nombre de dents | Pas de chaîne | Ø intérieur (mm) | Nombre de trous de fixation | Schéma |
|----------------|------------------------|-----------------|---------------|------------------|-----------------------------|--------|
| <b>PEUGEOT</b> |                        |                 |               |                  |                             |        |
| 2939           | 103 jantes batons tôle | 43              | 415           | 94               | 10                          | 20     |
| 2940           | 103 jantes batons tôle | 45              | 415           | 94               | 10                          | 20     |
| 2941           | 103 jantes batons tôle | 48              | 415           | 94               | 10                          | 20     |
| 2942           | 103 jantes batons tôle | 50              | 415           | 94               | 10                          | 20     |
| 2943           | 103 jantes batons tôle | 52              | 415           | 94               | 10                          | 20     |
| 2944           | 103 jantes batons tôle | 54              | 415           | 94               | 10                          | 20     |
| 2945           | 103 jantes batons tôle | 56              | 415           | 94               | 10                          | 20     |
| 165967         | 103 GRIMECA   BERNARDI | 40              | 415           | 98               | 10                          | 21     |
| 488069         | 103 GRIMECA   BERNARDI | 50              | 415           | 98               | 10                          | 21     |
| 2947           | 103 GRIMECA   BERNARDI | 42              | 415           | 98               | 10                          | 21     |
| 2948           | 103 GRIMECA   BERNARDI | 43              | 415           | 98               | 10                          | 21     |
| 2949           | 103 GRIMECA   BERNARDI | 45              | 415           | 98               | 10                          | 21     |
| 2951           | 103 GRIMECA   BERNARDI | 48              | 415           | 98               | 10                          | 21     |
| 2952           | 103 GRIMECA   BERNARDI | 52              | 415           | 98               | 10                          | 21     |
| 2953           | 103 GRIMECA   BERNARDI | 54              | 415           | 98               | 10                          | 21     |
| 2954           | 103 GRIMECA   BERNARDI | 56              | 415           | 98               | 10                          | 21     |
| 175202         | 103 GRIMECA   BERNARDI | 60              | 415           | 98               | 10                          | 21     |
| 244069         | 103 rayons             | 42              | 415           | 94               | 11                          | 22     |
| 2932           | 103 rayons             | 44              | 415           | 94               | 11                          | 22     |
| 2933           | 103 rayons             | 45              | 415           | 94               | 11                          | 22     |
| 2934           | 103 rayons             | 48              | 415           | 94               | 11                          | 22     |
| 2935           | 103 rayons             | 52              | 415           | 94               | 11                          | 22     |
| 2936           | 103 rayons             | 56              | 415           | 94               | 11                          | 22     |
| 2931           | 103 SL                 | 43              | 415           | 94               | 11                          | 23     |
| <b>MBK</b>     |                        |                 |               |                  |                             |        |
| 2962           | 65   85                | 44              | 415           | 98               | 6                           | 24     |
| 2968           | 51S GRIMECA            | 42              | 415           | 98               | 10                          | 25     |
| 2969           | 51S GRIMECA            | 45              | 415           | 98               | 10                          | 25     |
| 2970           | 51S GRIMECA            | 48              | 415           | 98               | 10                          | 25     |
| 2971           | 51S GRIMECA            | 52              | 415           | 98               | 10                          | 25     |
| 2972           | 51S GRIMECA            | 54              | 415           | 98               | 10                          | 25     |
| 2973           | 51S GRIMECA            | 56              | 415           | 98               | 10                          | 25     |
| 2974           | 51S GRIMECA            | 60              | 415           | 98               | 10                          | 25     |
| 2959           | 51V   41               | 56              | 415           | 94               | 11                          | 26     |
| 2960           | 51V   41 (noir)        | 56              | 415           | 94               | 11                          | 26     |
| 2957           | 40   50                | 44              | 415           | 94               | 10                          | 27     |
| 2958           | 40   50                | 54              | 415           | 94               | 10                          | 27     |
| 2963           | 68   88   89           | 54              | 415           | 110              | 6                           | 28     |
| 487353         | 68   88   89           | 48              | 415           | 110              | 6                           | 28     |
| 487354         | 40   50                | 48              | 415           | 94               | 10                          | 29     |
| 487355         | 51V   41               | 52              | 415           | 94               | 11                          | 26     |



## INFO TECHNIQUE

Retrouvez la graisse et le nettoyeur pour chaîne aux pages 620 et 632.



### CHAÎNE 420

|        |           | Couleur | Nombre de maillons |
|--------|-----------|---------|--------------------|
| 482972 | renforcée | blanc   | 134                |
| 482973 | renforcée | bleu    | 134                |
| 482975 | renforcée | jaune   | 134                |
| 475862 | renforcée | noir    | 134                |
| 487246 | renforcée | orange  | 134                |
| 482974 | renforcée | rouge   | 134                |
| 482971 | renforcée | vert    | 134                |

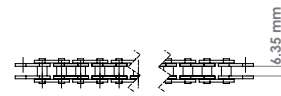

482972



482973



482975



475862



487246



482974



482971



### CHAÎNE 420

|        |                 | Couleur | Nombre de maillons |
|--------|-----------------|---------|--------------------|
| 475169 | super renforcée | or      | 134                |
| 475164 | super renforcée | or      | 106                |
| 485489 | super renforcée | or      | 120                |

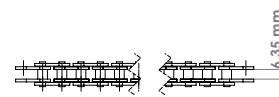

### CHAÎNE 420

|                       |               | Couleur | Nombre de maillons |
|-----------------------|---------------|---------|--------------------|
| 369905                | GSX renforcée | or      | 134                |
| 449720                | RXP renforcée | or      | 134                |
| <b>Attache rapide</b> |               |         |                    |
| 369140                | GSX renforcée | or      |                    |

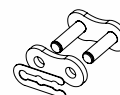
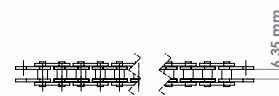



**IRIS**

## CHAÎNE 420

|                |             | Nombre de maillons |
|----------------|-------------|--------------------|
| 3046           | RX racing   | 134                |
| 228237         | TX standard | 134                |
| Attache rapide |             |                    |
| 369135         | RX racing   |                    |
| 228241         | TX standard |                    |

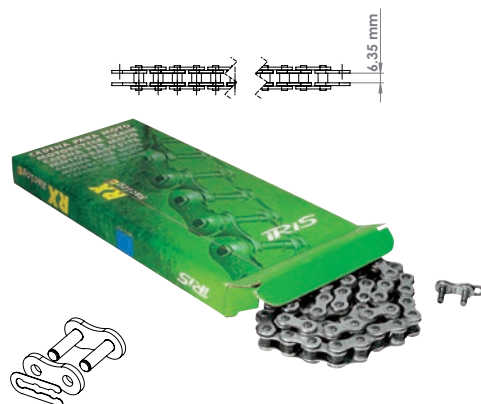

## CHAÎNE 420

|                |                        | Couleur | Nombre de maillons |
|----------------|------------------------|---------|--------------------|
| 485374         | super renforcée racing | or      | 134                |
| 485372         | renforcée              | or      | 134                |
| Attache rapide |                        |         |                    |
| 485379         | super renforcée racing | or      |                    |
| 483128         | renforcée              | or      |                    |



## CHAÎNE 420

|        |           | Couleur | Nombre de maillons |
|--------|-----------|---------|--------------------|
| 490795 | renforcée |         | 80                 |
| 490797 | renforcée | or      | 134                |
| 490789 | standard  |         | 108                |
| 490793 | standard  |         | 140                |



## CHAÎNE 428

|                |               | Couleur | Nombre de maillons |
|----------------|---------------|---------|--------------------|
| 369910         | GSX renforcée | or      | 134                |
| Attache rapide |               |         |                    |
| 369518         | GSX renforcée | or      |                    |
| 369503         | RX racing     |         |                    |
| 369127         | TX standard   |         |                    |



# CHAÎNE / CHAIN

MOTEUR



## CHAÎNE 428

|                       |           | Couleur | Nombre de maillons |
|-----------------------|-----------|---------|--------------------|
| 485375                | renforcée | or      | 134                |
| 485373                | standard  |         | 134                |
| <b>Attache rapide</b> |           |         |                    |
| 485376                | renforcée | or      |                    |
| 485378                | standard  |         |                    |

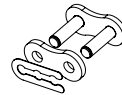
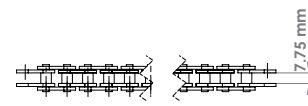

## CHAÎNE 428

|        |                  | Nombre de maillons |
|--------|------------------|--------------------|
| 490780 | O-RING renforcée | 120                |

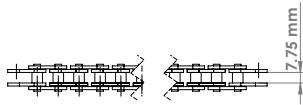

## CHAÎNE 520

|        |          | Nombre de maillons |
|--------|----------|--------------------|
| 490781 | standard | 120                |



## CHAÎNE 520

|        |           | Couleur | Nombre de maillons |
|--------|-----------|---------|--------------------|
| 369910 | renforcée | or      |                    |



## CHAÎNE 525

|        |                  | Nombre de maillons |
|--------|------------------|--------------------|
| 490778 | O-RING renforcée | 120                |



## CHAÎNE 530

|        |                  | Nombre de maillons |
|--------|------------------|--------------------|
| 490779 | O-RING renforcée | 120                |
| 490782 | renforcée        | 114                |





**CHAÎNE 3.30**

|                       |                                       | Nombre de maillons |
|-----------------------|---------------------------------------|--------------------|
| 487107                | pour démarrage à pédale/mise en route | 112                |
| <b>Attache rapide</b> |                                       |                    |
| 8864                  | x2                                    |                    |

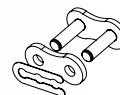
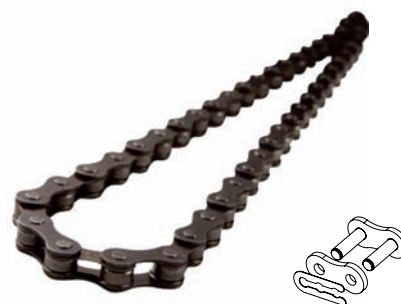

**CHAÎNE 415**

|                       |               | Couleur | Nombre de maillons |
|-----------------------|---------------|---------|--------------------|
| 3039                  | GSX renforcée | or      | 106                |
| 321025                | GSX renforcée | or      | 108                |
| 3040                  | GSX renforcée | or      | 120                |
| 3043                  | RX racing     |         | 120                |
| 3037                  | TX standard   |         | 106                |
| 259273                | TX standard   |         | 108                |
| 3038                  | TX standard   |         | 120                |
| <b>Attache rapide</b> |               |         |                    |
| 8871                  | GSX renforcée |         |                    |
| 8869                  | TX standard   |         |                    |
| 8862                  | standard      |         |                    |
| 8872                  | RX racing     |         |                    |
| 490774                | standard      | x50     |                    |

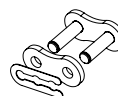

**CHAÎNE 415**

|        |           | Couleur | Nombre de maillons |
|--------|-----------|---------|--------------------|
| 493951 | renforcée | or      | 106                |
| 490784 | renforcée |         | 132                |
| 493949 | standard  | noir    | 106                |
| 493950 | standard  | or      | 106                |



**MAILLON CHAÎNE CYCLO 415**

|      |                                |
|------|--------------------------------|
| 8877 | coudé double 5T (faux maillon) |
|------|--------------------------------|





## ACCESSOIRE

Sélection  
**CGN**

### ROULEAU TENDEUR DE CHAÎNE

|        |       |          |                  |
|--------|-------|----------|------------------|
| 440593 | Ø32mm | axe Ø8mm | rouleau axe bras |
| 440592 | Ø42mm | axe Ø8mm | rouleau axe bras |



Sélection  
**CGN**

### TENDEUR DE CHAÎNE 50 À BOÎTE (X1)

|        |                              |               |
|--------|------------------------------|---------------|
| 482359 | DERBI SENDA                  | axe roue 12mm |
| 482360 | DERBI SENDA                  | axe roue 15mm |
| 484651 | TZR   X POWER   X-LIMIT   DT | axe roue 15mm |



482359



482360



484651

Sélection  
**CGN**

### TENDEUR DE CHAÎNE VÉLO POUR CYCLO

|        |  |           |
|--------|--|-----------|
| 3223   | TENDEUR CHAÎNE CYCLO<br>ADAPT. CIAO PX   BRAVO |           |
| 4296   | MBK ACIER                                      | acier     |
| 4295   | MBK  | plastique |
| 8895   | MBK  | 7x100     |
| 480894 | VOGUE   103   MVL                              |           |



3223



4296



4295



8895



480894

Sélection  
**CGN**

### TENDEUR DE CHAÎNE MOTEUR CYCLO

|      |                                  |                    |
|------|----------------------------------|--------------------|
| 8892 | MBK                              | avec écrou NYLSTOP |
| 8890 | MBK                              |                    |
| 8893 | MBK                              | 5x0.80             |
| 8889 | 103   MVL   VOGUE   SPX  <br>RCX |                    |



8892



8890



8893



8889

|                      |     |
|----------------------|-----|
| Amortisseur          | 447 |
| Autocollant          | 265 |
| Béquille             | 430 |
| Câble et gaine       | 524 |
| Carrosserie          | 276 |
| Compteur             | 362 |
| Contacteur/Alarme    | 381 |
| Déco                 | 273 |
| Disque de frein      | 458 |
| Eclairage            | 323 |
| Fourche              | 452 |
| Guidon               | 372 |
| Kick de démarrage    | 439 |
| Levier/Poignée       | 389 |
| Plaquette de frein   | 472 |
| Repose-pieds         | 435 |
| Rétroviseur          | 414 |
| Revêtement           | 407 |
| Sélecteur de vitesse | 445 |
| Selle                | 321 |

**JETHAL THREAT**

**7X11CM**



487151



487152



487150



487153



487156



487162



487159



487154



487155



487158



487165



480541



487120



487160



487161



487164



487157



487163



487118



494181



494182



497537

**7X25CM**



487149



480479



480480



487147



487148



486814



480481



480476



480477



494183

**Lethal Threat**

**8X14CM**



487113



487117



487116



487121



487114



487115



487110

**15X14CM**



480485



480492

**15X20CM**



487130



487131



487141



487143



487139



487133



480519



487136

**Lethal Threat**

15X20CM



487138



481384



487134



480506



487126



487128



487140



487142



487137



480510

30X20CM



493142



496748

467563

467564

494558

494557

12cm

11x1.8cm blanc fond transparent

11x1.8cm noir fond transparent

12cm

16cm

Sélection CGN



450231

458217

450204

458218

451745

459642

7x 9cm

8x10cm

8.5x5.5cm

9x8cm

10x10.5cm

10x8.5cm



441639

455014

449982

458947

449985

450205

14cm

16cm

6x10cm

6x10cm

6x10cm

8cm



459641

450521

459636

458220

458219

441642

10.6x8.5cm

6.5x9.5cm

8.2x6.9cm

8x12cm

8x12cm

10cm



450206

441646

441647

449996

441640

441638

12cm

8x11cm

10cm

11.5cm

15x5cm

16.5cm

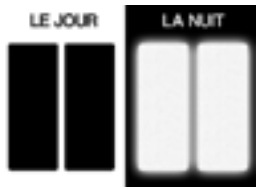

**497370**

2 pièces de 5x10cm  
réfléchissantes noires

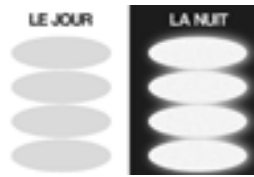

**497241**

4 autocollants réfléchissants  
pour casque 3M



**458222**

8x10cm



**368875**

10x12cm

**368880**

10x12cm



**368909**

10x12cm



**484108**

10x12cm



**368990**

14x16cm



**293126**

14x16cm



**369025**

14x16cm



**460912**

20x24cm



**451716**

35x25cm



**496004**

35x25cm



**497369**

50x70cm

**AUTOCOLLANT NUMÉRO BLANC**

|      |               | Longueur |
|------|---------------|----------|
| N° 0 | <b>449793</b> | 9cm      |
| N° 1 | <b>449794</b> | 9cm      |
| N° 2 | <b>449795</b> | 9cm      |
| N° 3 | <b>449796</b> | 9cm      |
| N° 4 | <b>449797</b> | 9cm      |
| N° 5 | <b>449798</b> | 9cm      |
| N° 6 | <b>449799</b> | 9cm      |
| N° 7 | <b>449800</b> | 9cm      |
| N° 8 | <b>449801</b> | 9cm      |
| N° 9 | <b>449802</b> | 9cm      |

|      |               | Longueur |
|------|---------------|----------|
| N° 0 | <b>441651</b> | 13cm     |
| N° 1 | <b>441652</b> | 13cm     |
| N° 2 | <b>441653</b> | 13cm     |
| N° 3 | <b>441654</b> | 13cm     |
| N° 4 | <b>441655</b> | 13cm     |
| N° 5 | <b>441656</b> | 13cm     |
| N° 6 | <b>441657</b> | 13cm     |
| N° 7 | <b>441658</b> | 13cm     |
| N° 8 | <b>441659</b> | 13cm     |
| N° 9 | <b>441660</b> | 13cm     |



Sélection  
CGN

## AUTOCOLLANT NUMÉRO NOIR

|      |        | Longueur |
|------|--------|----------|
| N° 0 | 461926 | 5.5cm    |
| N° 1 | 461927 | 5.5cm    |
| N° 2 | 461928 | 5.5cm    |
| N° 3 | 461929 | 5.5cm    |
| N° 4 | 461930 | 5.5cm    |
| N° 5 | 461931 | 5.5cm    |
| N° 6 | 461932 | 5.5cm    |
| N° 7 | 461933 | 5.5cm    |
| N° 8 | 461934 | 5.5cm    |
| N° 9 | 461935 | 5.5cm    |

|      |        | Longueur |
|------|--------|----------|
| N° 0 | 461936 | 9cm      |
| N° 1 | 461937 | 9cm      |
| N° 2 | 461938 | 9cm      |
| N° 3 | 461939 | 9cm      |
| N° 4 | 461940 | 9cm      |
| N° 5 | 461941 | 9cm      |
| N° 6 | 461942 | 9cm      |
| N° 7 | 461943 | 9cm      |
| N° 8 | 461944 | 9cm      |
| N° 9 | 461945 | 9cm      |

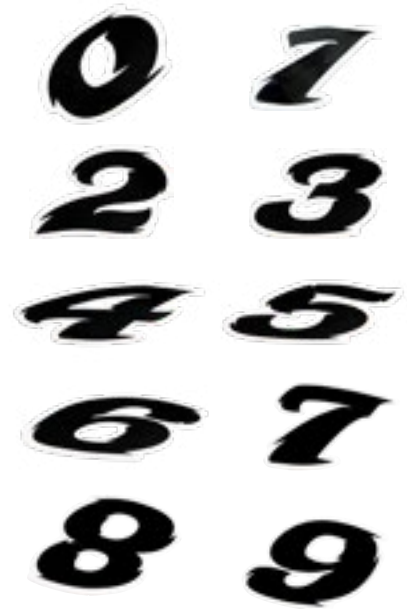
Sélection  
CGN

## AUTOCOLLANT NUMÉRO JAUNE

|      |        | Longueur |
|------|--------|----------|
| N° 0 | 440861 | 9cm      |
| N° 1 | 440862 | 9cm      |
| N° 2 | 440863 | 9cm      |
| N° 3 | 440864 | 9cm      |
| N° 4 | 440865 | 9cm      |
| N° 5 | 440866 | 9cm      |
| N° 6 | 440867 | 9cm      |
| N° 7 | 440868 | 9cm      |
| N° 8 | 440869 | 9cm      |
| N° 9 | 440870 | 9cm      |

MOTOP  
GERMANYAUTOCOLLANT LISERET POUR  
JANTE/CARROSSERIE (LONGUEUR  
10M)

|        |        |     |
|--------|--------|-----|
| 468165 | noir   | 6mm |
| 468172 | noir   | 9mm |
| 468162 | blanc  | 6mm |
| 468169 | blanc  | 9mm |
| 468164 | argent | 6mm |
| 468168 | argent | 9mm |
| 487964 | or     | 6mm |
| 487965 | or     | 9mm |
| 468167 | jaune  | 6mm |

|        |            |     |
|--------|------------|-----|
| 468171 | jaune      | 9mm |
| 468316 | jaune fluo | 6mm |
| 468174 | jaune fluo | 9mm |
| 468166 | rouge      | 6mm |
| 468173 | rouge      | 9mm |
| 468315 | rouge fluo | 6mm |
| 468175 | rouge fluo | 9mm |
| 468176 | vert fluo  | 9mm |
| 468163 | bleu       | 6mm |
| 468170 | bleu       | 9mm |
| 493971 | bleu foncé | 9mm |





**DOPPLER**

## PROTECTION RÉSERVOIR 13X19CM

- 485635      bleu
- 485633      jaune
- 485634      rouge
- 485636      vert



485635



485633



485634



485636

**LEthal Threat**

## PROTECTION RÉSERVOIR 18X23CM

- 487122      transparent
- 487123      tribal
- 494184      femme



487122



487123



494184

**TUN'R**

## PROTECTION RÉSERVOIR

- 293221      carbone



Sélection  
**CGN**

## PROTECTION RÉSERVOIR

- 293217      carbone
- 497371      bombing
- 497372      union jack



293217



497371



497372

**DOPPLER**

## PLANCHE AUTOCOLLANTS

- 461207      21x29.7cm



**MALOSSİ**

## PLANCHE AUTOCOLLANTS

- 294012      25x35cm





**PLANCHE AUTOCOLLANTS  
MONSTER ENERGY**

- 495692 50x28cm
- 495693 50x28cm



495692 495693



**PLANCHE AUTOCOLLANTS  
ROCKSTAR**

- 483972 49x33cm



**PLANCHE AUTOCOLLANTS MULISHA**

- 491231 49x33cm
- 491232 49x33cm



491231 491232



**PLANCHE AUTOCOLLANTS**

- 496692 21x29.7cm



**PLANCHE AUTOCOLLANTS**

- 196707 30x17cm
- 259948 2 planches de 50x35cm (1 gauche + 1 droite)



196707 259948



**PLANCHE AUTOCOLLANTS**

- 293312 20x24cm
- 369044 20x24cm
- 293289 20x24cm
- 460916 20x24cm
- 191337 50x35cm
- 487473 6 pièces
- 487474 2 pièces
- 451727



293312 369044 293289 460916



191337



487473



487474



451727



### BOMBE PEINTURE MÉTAL ACRYLIQUE 400ML

|     |        |
|-----|--------|
| 886 | noir   |
| 885 | argent |
| 883 | bleu   |
| 884 | rouge  |
| 882 | vert   |
| 887 | violet |



### BOMBE PEINTURE FLUO ACRYLIQUE 400ML

|        |              |
|--------|--------------|
| 480661 | jaune        |
| 480660 | rose         |
| 480659 | rouge orangé |
| 480662 | vert         |



### BOMBE PEINTURE GLYCÉRO 400ML

|        |                 |
|--------|-----------------|
| 480653 | noir satiné     |
| 888    | noir brillant   |
| 875    | noir mat        |
| 880    | argent          |
| 480654 | or              |
| 873    | blanc           |
| 876    | bleu lumineux   |
| 480651 | bleu ciel       |
| 878    | jaune colza     |
| 480652 | orange type KTM |
| 877    | rouge brillant  |
| 894    | vernis brillant |



### BOMBE PEINTURE DIVERSE 400ML

|        |                   |
|--------|-------------------|
| 893    | chrome            |
| 458275 | effet 3D pailleté |





### BOMBE PEINTURE POUR ÉTRIER DE FREIN 400ML

480655 jaune

480657 rouge



### BOMBE PEINTURE POUR JANTE 500ML

480658 argent



### BOMBE PEINTURE SPRAYPLAST RETIRABLE 400ML

490502 carbone brillant

490227 noir brillant

490226 noir mat

490228 blanc brillant

490229 vert brillant

490230 orange brillant

490231 transparent



↳ Approprié pour le traitement des jantes mais aussi pour les surfaces non absorbantes telles que le métal, les peintures bi-composantes, les plastiques durs ou le verre. Si la couleur ne convient plus, il suffit de retirer le film.



### BOMBE PEINTURE APPRÊT 400ML

- 322859** blanc anti-rouille glycéro
- 881** gris anti-rouille glycéro
- 231301** pour plastique



### BOMBE PEINTURE HAUTE TEMPÉRATURE 400ML

- 896** noir
- 172377** argent
- 489898** anthracite spécial bloc moteur
- 895** vernis



### POIGNÉE PISTOLET

- 490426** pour application aérosol/peinture



### CRAYON PNEU PILOT

- 169359** blanc



**TUN'R**
**BOOSTER | BW'S 2004->**

**477456**

 Kit type origine 4 pièces  
noir peint

**472583**

Tablier avant noir peint

**483690**

 Trappe moteur type origine  
noir

**472585**

Coque arrière noir peint

**TUN'R** **BOOSTER | BW'S 2004->**

**477457**

 Kit type origine 4 pièces  
blanc peint

**472584**

Tablier avant blanc peint

**483689**

 Trappe moteur type origine  
blanc

**472586**

Coque arrière blanc peint



## TUN'R

### BOOSTER | BW'S 2004->



**472587**

Tablier arrière, protège jambe intérieur noir peint



**476163**

Marche-pieds noir



**472652**

Bas de caisse noir



**482010**

Garde boue arrière noir type origine avec bavette et catadioptre\*



**479955**

Tablier arrière, protège jambe intérieur blanc peint



**476162**

Marche-pieds blanc



**472653**

Bas de caisse blanc peint



**482842**

Garde boue arrière blanc type origine avec bavette et catadioptre\*



### BOOSTER | BW'S 2004->



**467320**

Kit New Design 4 pièces noir peint



**467308**

Tablier avant New Design noir peint



**467313**

Capotage compteur noir peint



**467311**

Coque arrière New Design noir peint (paire)



**467316**

Trappe moteur noir



**467318**

Grille coque arrière New Design noir (paire)

\*Produits destinés à des concours tuning, usage interdit sur la voie publique.

**TUN'R BOOSTER | BW'S 2004->**

**475848**

 Kit New Design 4 pièces  
noir mat peint

**TUN'R BOOSTER | BW'S 2004->**

**467319**

 Kit New Design 4 pièces  
blanc peint

**467307**

 Tablier avant New Design  
blanc peint

**467314**

 Capotage compteur  
blanc peint

**467315**

Trappe moteur blanc

**467309**

 Coque arrière New Design  
blanc peint (paire)

**467317**

 Grille coque arrière  
New Design blanc (paire)





## BCD BOOSTER | BW'S 2004->



**481301**

Kit complet 9 pièces homologué noir



**473068**

Face avant New Design noir avec prise d'air



**473071**

Sabot New Design noir



**473067**

Coque arrière New Design noir avec passage de roue et feu stop



**483491**

Feu arrière LEDs homologué ailettes noir



**473069**

Bas de caisse New Design noir



**460397**

Double optique noir

## BCD BOOSTER | BW'S 2004->



**481300**

Kit 9 pièces homologué blanc



**475606**

Face avant New Design blanc avec prise d'air



**473072**

Sabot New Design blanc



**460398**

Sabot blanc



**475605**

Coque arrière New Design blanc avec passage de roue et feu stop



**483491**

Feu arrière LEDs homologué ailettes noir



**473070**

Bas de caisse New Design blanc



**460396**

Double optique blanc\*

\*Produits destinés à des concours tuning, usage interdit sur la voie publique.

**BCD BOOSTER | BW'S 2004->**

**481297**

Kit 8 pièces noir\* (Pack V1)

**473068**

Face avant New Design noir avec prise d'air

**460397**

Double optique noir

**473067**

Coque arrière New Design noir avec passage de roue et feu stop

**483491**

Feu arrière LEDs homologué ailettes noir

**473069**

Bas de caisse New Design noir

**460399**

Sabot noir

**473071**

Sabot New Design noir

**BCD BOOSTER | BW'S 2004->**

**481296**

Kit 8 pièces blanc\* (Pack V1)

**475606**

Face avant New Design blanc avec prise d'air

**460396**

Double optique blanc

**475605**

Coque arrière New Design blanc avec passage de roue et feu stop

**483491**

Feu arrière LEDs homologué ailettes noir

**473070**

Bas de caisse New Design blanc

**473072**

Sabot New Design blanc



## BCD BOOSTER | BW'S 2004->



**481299**

Kit 6 pièces homologué noir  
(Pack V2)



**473068**

Face avant New Design noir  
avec prise d'air



**473067**

Coque arrière New Design noir  
avec passage de roue  
et feu stop



**483491**

Feu arrière LEDs homologué  
ailettes noir



**473071**

Sabot New Design noir

## BCD BOOSTER | BW'S 2004->



**481298**

Kit 6 pièces homologué blanc  
(Pack V2)



**475606**

Face avant New Design blanc  
avec prise d'air



**475605**

Coque arrière New Design  
blanc avec passage de roue  
et feu stop



**483491**

Feu arrière LEDs homologué  
ailettes noir



**473072**

Sabot New Design blanc



BCD

BOOSTER | BW'S 2004-&gt;



484111

ecope LEDs intégrées blanc  
(paire)

BOOSTER | BW'S 2004-&gt;



483916

masque optique noir



483913

masque optique LEDS\* noir



483935

garde boue arrière pneu de 150  
noir

483937

garde boue arrière 12" et 13" noir



484803

passage de roue noir



483915

masque optique blanc



483914

masque optique LEDS\* blanc



483934

garde boue arrière pneu de 150  
blanc

483936

garde boue arrière 12" et 13"  
blanc

484804

passage de roue blanc

\*Produits destinés à des concours tuning, usage interdit sur la voie publique.



## TUN'R

### BOOSTER | BW'S | SPIRIT ->2003



**477458**

Kit type origine noir peint



**472574**

Tablier face avant noir

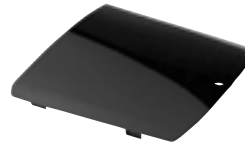

**472387**

Trappe moteur noir



**467966**

Capotage compteur New Design noir peint



**472580**

Coque arrière noir peint



### BOOSTER | BW'S | SPIRIT ->2003



**477459**

Kit type origine blanc peint



**472388**

Trappe moteur blanc



**467965**

Capotage compteur New Design blanc peint



**472582**

Coque arrière blanc peint



## BOOSTER | BW'S | SPIRIT ->2003



**TUN'R**

290988

Garde boue avant, spoiler tablier, bavette noir



**TUN'R**

375543

Garde boue arrière noir type origine avec bavette



**TUN'R**

489987

Aileron noir



**TUN'R**

329356

Poignée de maintien passager chrome



**TUN'R**

477514

Tablier arrière, protège jambe intérieur noir peint



**TUN'R**

477513

Bas de caisse noir peint



**TUN'R**

478398

Tablier arrière, protège jambe intérieur, blanc peint



**TUN'R**

477512

Bas de caisse blanc peint



**TUN'R**

2513

Console auto-radio



**FACO**

290940

tablier face avant noir mat



**FACO**

297477

Marche-pieds noir mat



**FACO**

291013

bas de caisse noir mat



**FACO**

458249

Marche-pieds blanc



**FACO**

458250

bas de caisse blanc peint



## BOOSTER | BW'S | SPIRIT ->2003



483939

garde boue arrière 10" noir



483938

garde boue arrière 10" blanc



483937

garde boue arrière 12" 13" noir



483936

garde boue arrière 12" 13" blanc



## TUN'R BOOSTER | BW'S | SPIRIT ->2003



**467367**

Kit 3 pièces New Design  
noir peint



**462602**

Tablier face avant New Design  
noir peint



**467966**

Capotage compteur New  
Design noir peint



**465547**

Coque arrière New Design  
noir peint (paire)

## TUN'R BOOSTER | BW'S | SPIRIT ->2003



**467366**

Kit New Design blanc peint



**462611**

Tablier face avant New Design  
blanc peint



**467965**

Capotage compteur  
New Design blanc peint



**465546**

Coque arrière New Design  
blanc peint (paire)

## BCD BOOSTER | BW'S | SPIRIT ->2003



**461638**

face avant double optique\* 2x20W noir



**440852**

bas de caisse noir



**364095**

sabot noir



**461637**

face avant double optique\* 2x20W blanc



**440853**

bas de caisse blanc



**364087**

sabot blanc

**TUN'R**
**BOOSTER NG**

**467953**

Kit 6 pièces noir peint

**467958**

Tablier face avant noir peint

**467956**

Capotage compteur noir peint

**467962**

Coque arrière noir peint (paire)

**381913**

Jonction de coque arrière noir

**TUN'R**
**BOOSTER NG**

**467952**

Kit 6 pièces blanc peint

**467957**

 Tablier, face avant 1999->  
blanc peint

**467961**

 Coque arrière blanc peint  
(paire)

**381947**

 Jonction de coque arrière  
blanc





**TUN'R** ROCKET | NEXT



**475847**

Kit 5 pièces noir mat peint

**TUN'R** ROCKET | NEXT



**472385**

Kit 5 pièces noir peint



**478929**

Tablier face avant noir peint



**467956**

Capotage compteur noir peint



**467962**

Coque arrière noir peint (paire)



**381913**

Jonction de coque arrière noir

**TUN'R** ROCKET | NEXT



**472386**

Kit 5 pièces blanc peint



**478928**

Tablier face avant blanc peint



**467961**

Coque arrière blanc peint (paire)



**381947**

Jonction de coque arrière blanc



TUN'R

## BOOSTER NG | ROCKET | NEXT



467964

trappe moteur noir peint



467755

garde boue noir



381913

jonction de coque arrière noir



467753

garde boue blanc



381947

jonction de coque arrière blanc



467754

garde boue carbone



381928

jonction de coque arrière carbone



381932

jonction de coque arrière chrome



## ROCKET | NEXT 1 ET 2 | NG

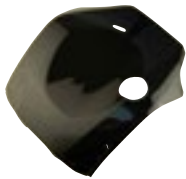

481309

passage de roue noir



373058

Sabot noir



481308

passage de roue blanc



## NITRO | AEROX 2013-&gt;



487691

Kit 7 pièces type origine noir



496109

Tablier face avant supérieur  
type origine noir peint

496108

Tablier face avant inférieur  
type origine noir peint

496107

Capotage compteur supérieur  
noir peint

496110

Coque arrière gauche  
noir peint

496111

Coque arrière droite noir peint



494799

Garde boue arrière type origine,  
bavette et catadiopre, noir



## NITRO | AEROX 2013->



**486428**

coque arrière (passage de roue, support plaque) noir



**486429**

coque arrière (passage de roue, support plaque) blanc

## TUN'R NITRO | AEROX ->2013



**482947**

Kit 4 pièces type origine noir peint



**467984**

Tablier face avant inférieur type origine noir peint



**467363**

Tablier face avant supérieur type origine noir peint



**472567**

Coque arrière droite type origine noire



**472568**

Coque arrière gauche type origine noire

## TUN'R NITRO | AEROX ->2013



**482946**

Kit 4 pièces type origine blanc peint



**482976**

Tablier face avant inférieur blanc peint type or



**482942**

Tablier face avant supérieur blanc peint type or



**482945**

Coque arrière gauche type origine blanc



**482944**

Coque arrière droite type origine blanc



TUN'R

NITRO | AEROX -&gt;2013



467951

Kit 8 pièces New Design  
noir peint

484567

Tablier face avant inférieur  
New Design noir peint

484566

Tablier face avant supérieur  
New Design noir peint

468004

Capotage compteur inférieur  
noir peint

467982

Coque arrière noir peint (paire)



467986

Capot moteur noir peint (paire)



482950

Passage de roue noir peint



TUN'R NITRO | AEROX -&gt;2013



467950

Kit 8 pièces New Design  
blanc peint

467983

Tablier face avant inférieur  
New Design blanc peint

467362

Tablier face avant supérieur  
New Design blanc peint

467981

Coque arrière blanc peint  
(paire)

467985

Capot moteur blanc peint  
(paire)

482949

Passage de roue blanc peint



**TUN-R**

**NITRO | AEROX ->2013**



**482952**

Capotage compteur supérieur  
noir peint



**468004**

Capotage compteur inférieur  
noir peint



**472572**

Capot moteur gauche noir



**472571**

Capot moteur droit noir



**467821**

Garde boue avant noir



**482948**

Coque moteur central type  
origine noir



**477519**

Trappe batterie de marche pied  
noir



**472570**

Tablier arrière, protège jambe  
intérieur noir



**477518**

Bas de caisse noir peint



**483215**

Dossieret, capot selle noir



**477516**

Marche-pieds noir



**482951**

Capotage compteur supérieur  
blanc peint



**467818**

Garde boue avant blanc



**480874**

Trappe batterie de marche-pied  
blanc



**482943**

Tablier arrière, protège jambe  
intérieur blanc



**477517**

Bas de caisse blanc peint



**483216**

Dossieret, capot de selle blanc



**477515**

Marche-pieds blanc



**494799**

Garde boue arrière type origine,  
bavette et catadiopre, noir



BCD

## NITRO | AEROX -&gt;2013



466603

coque arrière Xtreme et dossier  
noir

466589

passage de roue Xtreme noir



450014

passage de roue noir



466899

dossieret, capot de selle Xtreme  
noir

466602

coque arrière Xtreme et dossier  
blanc

466588

passage de roue Xtreme blanc



450013

passage de roue blanc



466898

dossieret, capot de selle Xtreme  
blanc

458143

bas de caisse blanc



## NITRO | AEROX -&gt;2013



484359

masque optique LEDS\* noir



483946

passage de roue, feu clignotant intégré\* noir



483947

passage de roue, feu clignotant intégré\* blanc



## NITRO | AEROX | MACH G



483930

garde boue arrière noir



483931

garde boue arrière blanc



## TUN'R

### STUNT | SLIDER NAKED 2005->



**476315**

Kit 11 pièces noir peint



**479407**

Tablier face avant noir peint



**479410**

Dessous de tablier avant noir peint



**479409**

Dessus de tablier avant noir peint



**479447**

Garde boue avant noir



**479450**

Protection, pad latéral noir x4 pour carrosserie TUN'R



**479413**

Coque arrière noir (paire)



**479411**

Tablier arrière, protège jambe noir peint



### STUNT | SLIDER NAKED 2005->



**476316**

Kit 11 pièces blanc peint



**479084**

Tablier face avant blanc peint



**479085**

Dessus tablier avant blanc peint



**479086**

Dessous tablier avant blanc peint



**479090**

Garde boue avant blanc



**479450**

Protection, pad latéral noir x4 pour carrosserie TUN'R



**479088**

Coque arrière blanc (paire)



**479087**

Tablier arrière, protège jambe intérieur blanc peint



## TUN'R STUNT | SLIDER



**478301**

Protection, pad latéral avant  
arrière noir x4



**493139**

Protection, pad latéral avant noir  
avec LEDs\* x2



**494800**

Garde boue arrière type origine,  
bavette, noir

## BCD STUNT | SLIDER



**481288**

face avant double optique\*  
avec grille et optique noir  
homologué CE



**481285**

face avant double optique  
Xtreme\* avec grille et optique  
2x20W noir



**364406**

protection, pad latéral avant  
et arrière x4 noir



**467705**

coque arrière Xtreme 2 parties  
avec protections avant noir



**460403**

bas de caisse noir



**466605**

sabot Xtreme en trois parties noir



**481307**

passage de roue Xtreme noir,  
suppression du réservoir d'huile



**468286**

passage de roue noir



**481287**

face avant double optique\*  
avec grille et optique blanc  
homologué CE



**481284**

face avant double optique  
Xtreme\* avec grille et optique  
2x20W blanc



**364391**

protection, pad latéral avant  
et arrière x4 blanc



**467704**

coque arrière Xtreme 2 parties  
avec protections avant blanc



**460402**

bas de caisse blanc



**466604**

sabot Xtreme en trois parties  
blanc



**481306**

passage de roue Xtreme blanc,  
suppression du réservoir d'huile



**468285**

passage de roue blanc





## STUNT | SLIDER

|   |   |  |   |
|---|---|--|---|
|  |  |  |  |
| <b>483937</b>   | <b>483936</b>   | <b>483939</b>  | <b>483938</b>   |
| Garbe boue arrière 12" et 13" noir  | Garbe boue arrière 12" et 13" blanc   | Garbe boue arrière 10" noir  | Garbe boue arrière 10" blanc  |



## OVETTO | NEOS ->2007

↳ INFO + :

Les faces avant sont livrées avec des lampes dichroïques.\*

|  |  |   |   |
|--|--|---|---|
|  |   |   |  |
| <b>479177</b>  | <b>491481</b>  | <b>491482</b>   | <b>491484</b>   |
| Kit 4 pièces type origine noir peint   | Tablier, face avant noir   | Capotage compteur noir  | Garde boue avant noir   |
|  |  |  |   |
|  | <b>491483</b>  | <b>494798</b>   |   |
|  | Coque arrière noire (paire)  | Garde boue arrière, bavette, type origine noir                                      |   |



## OVETTO | NEOS 2008 ->

|   |   |  |   |
|---|---|--|---|
|  |  |  |  |
| <b>490343</b>   | <b>479787</b>   | <b>479788</b>  | <b>479789</b>   |
| Kit 7 pièces type origine noir  | Tablier, face avant supérieur noir  | Tablier, face avant inférieur noir (paire)   | Capotage compteur noir  |
|   |  |  |  |
|   | <b>479786</b>   | <b>479790</b>  | <b>484684</b>   |
|   | Garde boue avant noir   | Coque arrière noir (paire)   | Marche-pieds noir   |

**TUN'R LUDIX**

**467331**

 Kit 5 pièces compteur rond  
noir peint

**467323**

 Tablier, face avant compteur  
rond noir peint

**467328**

Tablier latéral noir

**467312**

Coque arrière noir peint (paire)

**TUN'R LUDIX**

**467332**

 Kit 5 pièces compteur  
triangulaire noir peint

**467324**

 Tablier, face avant compteur  
triangulaire noir peint

**467328**

Tablier latéral noir

**467312**

Coque arrière noir peint (paire)



## TUN'R LUDIX



**482206**

tablier, face avant\* double optique 2x20W + LEDs\* noir compteur triangle



**467322**

Tablier, face avant, compteur triangulaire, blanc peint



**482207**

tablier, face avant\* double optique 2x20W + LEDs\* blanc compteur triangle



**467327**

Tablier latéral blanc



**494802**

Garde boue arrière 10", 12", 14" type origine 763722N



**494803**

Garde boue avant 14" type origine 771768 noir brut

## BCD LUDIX



**460928**

Face avant double optique halogène 2x20W\* pour compteur triangle noir



**466593**

Face avant simple optique noir



**466901**

écope noir



**460922**

Coque arrière noir



**466601**

Sabot Xtreme noir



**460927**

Face avant double optique halogène 2x20W\* pour compteur triangle blanc



**460925**

écope blanc



**460921**

Coque arrière blanc



**466594**

sabot blanc

\*Produits destinés à des concours tuning, usage interdit sur la voie publique.



## LUDIX | SPEEDFIGHT 3 | LUDIX BLASTER | JET FORCE



**483933**

Garde boue arrière noir jusqu'à 12"



**483932**

Garde boue arrière blanc jusqu'à 12"



## SPEEDFIGHT 2



**466591**

Passage de roue Xtreme noir



**466590**

Passage de roue Xtreme blanc



## SPEEDFIGHT 1 ET 2



**374179**

Garde boue arrière, lèche roue noir



## SPEEDFIGHT 1 ET 2



**480872**

Marche-pieds noir mat



**480871**

Marche-pieds blanc



**TUN'R** TREKKER | TKR



**476858**

Kit 7 pièces noir peint



**483060**

Tablier, face avant supérieur  
type origine noir peint



**489605**

Capotage compteur noir peint  
(sans fixation)



**480898**

Garde boue avant type Showa  
inversé noir peint



**494103**

Coque arrière noir (paire)

**TUN'R** TREKKER | TKR



**476859**

Kit 7 pièces blanc peint



**BCD** TREKKER | TKR



TREKKER | TKR



**481311**

sabot noir



**481310**

sabot blanc



**483948**

passage de roue noir



**483949**

passage de roue blanc

**TUN'R** VIVACITY 1998->



**480899**

Kit 5 pièces noir peint



**494016**

Tablier, face avant supérieur noir peint



**494017**

Tablier, face avant inférieur noir peint



**494015**

Capotage compteur noir peint



**494019**

Coque arrière gauche noir peint



**494018**

Coque arrière droite noir peint



**480898**

Garbe boue avant type Showa inversé, livré sans patte, noir peint



**TUN'R** ZIP 2000->



**480751**

Tablier, face avant noir peint

**490297**

Capotage compteur noir peint

**479284**

Garde boue avant noir



**479285**

Kit 4 pièces noir



**482954**

Coque arrière noir peint (paire)

**TUN'R** ZIP 2000->



**480752**

Tablier, face avant blanc peint

**490298**

Capotage compteur  
blanc peint

**482956**

Garde boue avant blanc peint



**479286**

Kit 4 pièces blanc



**TUN'R STALKER**



**477724**

Kit 5 pièces noir



**472590**

Tablier, face avant noir



**472589**

Coque arrière droite noire



**TUN'R STALKER**



**482953**

Kit 5 pièces blanc



**483048**

Tablier, face avant blanc



**483035**

Coque arrière gauche

**FACO TYPHOON**



**451880**

Kit 4 pièces noir mat à peindre



**291047**

Tablier, face avant noir mat



**2591**

Capotage compteur noir mat



**TYPHOON ->2011 | NRG MC1**



**481305**

passage de roue noir





## TUN'R AGILITY 50 | 125



**479288**

Kit 6 pièces, selle en 2 parties,  
noir



**479289**

Garde boue avant noir

## TUN'R AGILITY 50 | 125



**479287**

Kit 6 pièces, selle en 2 parties,  
blanc

## BCD SR50 STREET



**466912**

Passage de roue Xtreme blanc

## BCD RUNNER



**466905**

écope arrière (paire) noir

## KEEWAY FOCUS | F-ACT | CPI OLIVER



**483944**

dossieret, capot selle noir



**483941**

garde boue arrière noir



**483955**

passage de roue noir



**483945**

dossieret, capot selle blanc



**483940**

garde boue arrière blanc



**483956**

passage de roue blanc



## KEEWAY FOCUS | F-ACT



## KEEWAY F-ACT | MATRIX | RY8



483917

masque optique\* noir



485913

garde-boue arrière, bavette,  
support plaque noir

485886

garde-boue arrière, lèche roue  
noir

## KEEWAY F-ACT



485899

capotage compteur noir peint



485907

trappe moteur noir



485903

bas de caisse noir peint



485902

tablier arrière, protège jambe  
intérieur noir

485904

plaque cache numéros de cadre  
noir

## KEEWAY RY6



487258

marche pied noir

CARROSSERIE / BODY KIT



**TUN'R SYM MID**



**484858**

Kit 10 pièces blanc

**TUN'R SYM MID**



**484786**

Kit 10 pièces noir



**484793**

marche-pied noir



**484794**

tablier arrière, protège jambe intérieur noir

**TUN'R SCOOTER CHINOIS**



**494784**

Tablier, face avant noir



**485923**

Capotage compteur noir



**485921**

Garde boue avant noir



**485928**

Kit 7 pièces noir peint



**485931**

Marche pied noir



**494786**

Coque arrière gauche supérieure et inférieure noir



**494785**

Coque arrière droite supérieure et inférieure noir



**485930**

Tablier arrière, protège jambe intérieur, partie inférieure



**485929**

Tablier arrière, protège jambe intérieur, partie supérieure



**485932**

Garde boue arrière, bavette

**TUN'R**
**TURBINE BLANCHE**
**460339** BOOSTER | BW'S | STUNT | SLIDER | OVETTO | NEOS

**TEKNIX**
**TURBINE BLANCHE**
**485867** CPI | KEEWAY

**TUN'R**
**CACHE TURBINE**

|               |   |         |
|---------------|---|---------|
| <b>294964</b> | BOOSTER   BW'S   STUNT   SLIDER               | noir    |
| <b>294926</b> | BOOSTER   BW'S   STUNT   SLIDER               | carbone |
| <b>294911</b> | BOOSTER   BW'S   STUNT   SLIDER               | chrome  |
| <b>294937</b> | BOOSTER   BW'S   STUNT   SLIDER               | rouge   |
| <b>460331</b> | BOOSTER   BW'S                                | blanc   |
| <b>472596</b> | BOOSTER   BW'S 2004->   STUNT   SLIDER 2004-> | noir    |
| <b>472595</b> | BOOSTER   BW'S 2004->   STUNT   SLIDER 2004-> | carbone |
| <b>472597</b> | BOOSTER   BW'S 2004->   STUNT   SLIDER 2004-> | blanc   |
| <b>485866</b> | KEEWAY   CPI                                  | noir    |
| <b>462485</b> | LUDIX   | noir    |
| <b>473454</b> | PIAGGIO TYPHOON   STALKERZIP                  | noir    |



294964



294926



294911



294937



460331



472596



472595



472597



485866



462485



473454



## TUN'R

### RÉCUPÉRATEUR D'AIR UNIVERSEL

|        |                  |
|--------|------------------|
| 295023 | noir             |
| 294979 | chrome           |
| 462149 | carbone mat      |
| 462148 | carbone brillant |
| 460333 | blanc            |
| 295019 | bleu             |
| 295004 | violet           |



295023

294979

462149

462148

460333

295019

295004

## TUN'R

### RÉCUPÉRATEUR D'AIR NEW DESIGN

|        |                       |              |
|--------|-----------------------|--------------|
| 472598 | BOOSTER   BW'S 2004-> | chrome       |
| 472599 | BOOSTER   BW'S 2004-> | bleu anodisé |



472598



472599

## TUN'R

### PLAQUE CACHE NUMÉROS DE CADRE MBR | YAMAHA

|        |                             |             |
|--------|-----------------------------|-------------|
| 472390 | BOOSTER   BW'S              | noir verni  |
| 455401 | BOOSTER   BW'S type origine | noir        |
| 455404 | BOOSTER   BW'S              | carbone     |
| 472389 | BOOSTER   AEROX             | blanc verni |



472390

455401

455404

472389

## BCD

### GARDE BOUE AVANT

|        |  |
|--------|--|
| 472117 | LUDIX   STUNT   NRG   STALKER   TYPHOON  <br>fourche DOPPLER   carbone |
|--------|--|





DERBI SENDA XTREM | X RACE 2000->2011 | DRD 2000->2006



**472640**

Kit 8 pièces noir



**481442**

Tête de fourche noire



**472562**

Garde boue avant noir



**472564**

Ouïe avant gauche noire



**472563**

Ouïe avant droite noire



**472566**

Coque arrière gauche noire



**472565**

Coque arrière droite noire



**472639**

Garde boue arrière noir



**475173**

Trappe essence noir



DERBI SENDA XTREM | X RACE 2000->2011 | DRD 2000->2006



**473338**

Kit 8 pièces



**481765**

Tête de fourche blanc



**481828**

Garde boue avant blanc



**481827**

Garde boue arrière blanc



**482408**

Trappe essence blanc



TUN'R

DERBI | SENDA XTREM | X 2000->2011 | DRD ->2006



497382



497383



497384



497385



DERBI SENDA XTREM | X RACE 2000->2011 | DRD 2000->2006



**483918**

masque optique LEDs\* noir



**483919**

masque optique LEDs\* blanc



DERBI SENDA DRD RACING 2006 -> 2010



**486900**

Kit 8 pièces noir



**486894**

Tête de fourche noir



**486898**

Ouïe avant gauche noir



**486899**

Ouïe avant droite noir



**486892**

Garde boue avant noir



**486893**

Trappe essence noir



**486897**

Coque arrière gauche noir



**486896**

Coque arrière droite noir



**486891**

Garde boue arrière noir





**TUN'R**

**DERBI SENDA DRD RACING 2006 -> 2010**



**486901**

Kit 8 pièces blanc



**DERBI SENDA | GILERA 2011 -> | RCR | SMT 2011->**



**487967**

Kit 8 pièces noir



**487969**

Tête de fourche noire



**487976**

Trappe essence noire



**487971**

Ouïe avant gauche noire



**487970**

Ouïe avant droite noire



**487972**

Garde boue avant noir



**487975**

Coque arrière noire



**494748**

Kit 6 pièces noir



**487973**

Coque arrière gauche noire



**487974**

Coque arrière droite noire



DERBI SENDA | GILERA 2011 -> | RCR | SMT 2011->



**487968**

Kit 8 pièces blanc

**495603**

Kit 6 pièces blanc



**495605**

Tête de fourche blanc



**495606**

Ouille avant gauche blanc



**495608**

Ouille avant droite blanc



**495610**

Garde boue avant blanc



**495609**

Coque arrière blanc



DERBI GPR 50/125 2004->2010 | RS50 2006->2010



**483920**

masque optique LEDs\* noir

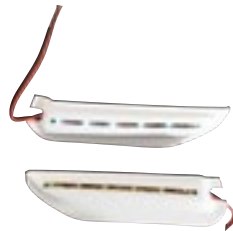

**483921**

masque optique LEDs\* blanc



DERBI | SENDA EURO 2 ->2006



**472638**

cache pompe à huile noir/  
chrome

\*Produits destinés à des concours tuning, usage interdit sur la voie publique.



## PASSAGE DE ROUE XPOWER | TZR 50 2004->

- |        |                      |  |
|--------|----------------------|--|
| 483953 | blanc avec feu blanc |  |
| 483952 | noir avec feu blanc  |  |
| 483954 | noir avec feu fumé   |  |

## Feu arrière universel fixation verticale TZR homologué CE

- |        |                                 |  |
|--------|---------------------------------|--|
| 467864 | rouge à LEDs                    |  |
| 467865 | transparent à LEDs              |  |
| 490445 | fumé à LEDs, clignotant intégré |  |
| 490354 | fumé à LEDs                     |  |



483953

483952

483954



467864

467865



490445

490354



## PASSAGE DE ROUE RS50 | TUONO 1999->2000\*

- |        |   |  |
|--------|---|--|
| 483951 | blanc avec feu blanc clignotant intégré |  |
|--------|---|--|



## GARDE-BOUE AVANT EXURA UNIVERSEL

- |        |       |
|--------|-------|
| 468145 | noir  |
| 468143 | blanc |



468145

468143

## GARDE-BOUE AVANT SUPER MOTARD UNIVERSEL

- |        |            |  |
|--------|------------|--|
| 460871 | blanc      |  |
| 460878 | bleu yam   |  |
| 460876 | noir       |  |
| 460875 | orange KTM |  |
| 460873 | rouge      |  |
| 488072 | gris       |  |



460871

460878

460876



460875

460873

488072

\*Produits destinés à des concours tuning, usage interdit sur la voie publique.

**TUN'R**
**GARDE-BOUE AVANT SUPER MOTARD  
UNIVERSEL 2 PIÈCES**

|               |              |
|---------------|--------------|
| <b>483832</b> | noir   noir  |
| <b>483831</b> | blanc   noir |
| <b>483833</b> | rouge   noir |



483832

483831

483833

**TUN'R**
**RENFORT GARDE BOUE**

|               |                  |      |
|---------------|------------------|------|
| <b>452037</b> | avant et arrière | noir |
|---------------|------------------|------|

**TUN'R**
**SABOT MOTEUR SANS FIXATION**

|               |                    |        |
|---------------|--------------------|--------|
| <b>475868</b> | DERBI SENDA ->2011 | argent |
| <b>475869</b> | AM6                | argent |

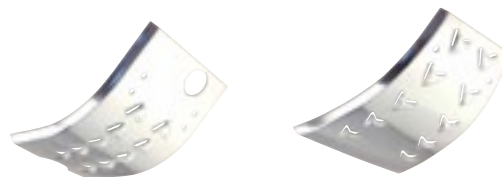

475868

475869

**TUN'R**
**CACHE PIGNON AMG**

|               |         |
|---------------|---------|
| <b>454974</b> | chrome  |
| <b>454976</b> | carbone |
| <b>454975</b> | bleu    |



454974

454976

454975



## TUN'R

### CARTER ALLUMAGE

|               |                    |                |
|---------------|--------------------|----------------|
| <b>441732</b> | AM6   CPI          | chrome         |
| <b>441731</b> | AM6   CPI          | carbone        |
| <b>489215</b> | AM6   CPI          | blanc          |
| <b>441733</b> | AM6   CPI          | bleu           |
| <b>482237</b> | DERBI SENDA EURO 3 | noir           |
| <b>482236</b> | DERBI SENDA EURO 3 | carbone        |
| <b>472637</b> | DERBI SENDA EURO 2 | noir   chrome  |
| <b>467342</b> | DERBI SENDA EURO 2 | lighty carbone |



441732



441731



489215

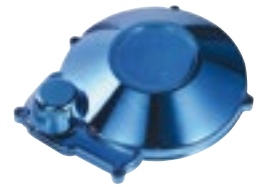

441733



482237



482236



472637



467342

## TUN'R

### BOUCHON MISE À L'AIR LIBRE, RENIFLARD, ALU CNC (X1)

|               |                            |        |
|---------------|----------------------------|--------|
| <b>487565</b> | MOTO   CROSS   QUAD   DIRT | noir   |
| <b>487564</b> | MOTO   CROSS   QUAD   DIRT | argent |
| <b>487566</b> | MOTO   CROSS   QUAD   DIRT | bleu   |
| <b>487563</b> | MOTO   CROSS   QUAD   DIRT | rouge  |
| <b>487567</b> | MOTO   CROSS   QUAD   DIRT | or     |



487565



487564



487566



487563



487567

**DOPPLER**
**TÊTE DE FOURCHE RACING UNIVERSELLE**
**461878** rouge

**461877** bleu

461878



461877

**BCD**
**TÊTE DE FOURCHE UNIVERSELLE**
**458712** blanc

**BCD**
**PIÈCES DÉTACHÉES DOUBLE OPTIQUE**
**369632** lampe, ampoule tous modèles sauf TF40 | TF70 et face avant BOOSTER

**464896** lampe, ampoule tous modèles sauf TF40 | TF70 et face avant BOOSTER

**441945** douille pour double optique

369632



464896



441945

**Polisport**
**TÊTE DE FOURCHE EXURA**
**468155** homologué CE

blanc

**468157** homologué CE

noir



468155



468157



## TÊTE DE FOURCHE\*

|               |  |                     |
|---------------|--|---------------------|
| <b>480452</b> | plaque numéro type cross avec fixation                 | noir                |
| <b>480453</b> | plaque numéro type cross avec fixation                 | blanc               |
| <b>481925</b> | plaque numéro type KTM avec fixation                   | noir                |
| <b>481926</b> | plaque numéro type KTM avec fixation                   | blanc               |
| <b>482200</b> | plaque numéro type KTM avec fixation                   | orange              |
| <b>483051</b> | plaque numéro type KTM avec fixation                   | vert                |
| <b>476767</b> | Xtrem Race, optique halogène 2x20W Ø50mm LEDs blanches | noir                |
| <b>476766</b> | Xtrem Race, optique halogène 2x20W Ø50mm LEDs blanches | blanc               |
| <b>376808</b> | cross 2 double optique halogène 2x20W                  | noir                |
| <b>376789</b> | cross 2 double optique halogène 2x20W                  | blanc               |
| <b>481187</b> | numéro, double optique halogène 2x20W                  | noir                |
| <b>440602</b> | numéro, double optique halogène 2x20W                  | blanc               |
| <b>458926</b> | numéro, double optique halogène 2x20W                  | bleu                |
| <b>440601</b> | racing, double optique halogène 2x20W                  | noir                |
| <b>440598</b> | racing, double optique halogène 2x20W                  | blanc               |
| <b>441892</b> | avec optique rectangulaire                             | carbone             |
| <b>477441</b> | XR8 double optique halogène 2x20W                      | noir LEDs blanches  |
| <b>477440</b> | XR8 double optique halogène 2x20W                      | blanc LEDs blanches |
| <b>488148</b> | naked avec clignotants                                 | noir                |
| <b>488147</b> | naked avec clignotants                                 | blanc               |
| <b>483828</b> | blaster 12V 35W  | orange              |
| <b>483827</b> | blaster 12V 35W  | rouge               |



\*Produits destinés à des concours tuning, usage interdit sur la voie publique.



### TÊTE DE FOURCHE\*

|               |                       |      |
|---------------|-----------------------|------|
| <b>494124</b> | plaque numéro type YZ | bleu |
| <b>494125</b> | plaque numéro type YZ | noir |
| <b>494126</b> | plaque numéro type YZ | bleu |



494124



494125



494126



### SANGLE POUR TÊTE DE FOURCHE (X4)

**482260** pour tête de fourche TUN'R



### ACCESSOIRE

|               |  |
|---------------|--|
| <b>485344</b> | porte de boîte à outils 103   VOGUE   MVL   SP AM réservoir3L7, porte et cache droit |
| <b>485345</b> | porte bagage arrière 103 SP   VOGUE   MVL   SPX chrome                               |
| <b>496084</b> | tringle 103 MVL fixation garde-boue/amortisseur                                      |
| <b>496083</b> | porte bagage 103 MVL   VOGUE arrière chrome  |



485344



485345



496084



496083





## TUN'R

### TÊTE DE FOURCHE\*

|        |                       |       |
|--------|-----------------------|-------|
| 494031 | plaque numéro type YZ | noir  |
| 494032 | plaque numéro type YZ | blanc |
| 494033 | plaque numéro type YZ | bleu  |
| 494278 | plaque numéro type YZ | vert  |



494031



494032



494033



494278



## TUN'R

### GRILLE FOURCHE

|        |                 |        |
|--------|-----------------|--------|
| 479170 | 103 MVL   VOGUE | chrome |
|--------|-----------------|--------|



Sélection  
**CGN**

### GARDE BOUE

|      |                            |        |
|------|----------------------------|--------|
| 2793 | F1                         | noir   |
| 2788 | 103 MVL                    | chrome |
| 2789 | 104 MVL                    | chrome |
| 2786 | 103 SP                     | chrome |
| 2787 | 103 SP                     | chrome |
| 3395 | CIAO PX                    | noir   |
| 844  | tous modèles cyclo arrière | chrome |



2793



2788



2789



2786



2787



3395



844

\*Produits destinés à des concours tuning, usage interdit sur la voie publique.



Sélection  
**CGN**

### COLLIER FIXATION GARDE BOUE AVANT (XI)

496077 103 MVL | VOGUE



**TUN'R**

### RAIDISSEUR DE CADRE CHROME

|        |               |            |
|--------|---------------|------------|
| 2552   | 103 SP   MVL  | coudé rond |
| 2553   | 103 SP   MVL  | droit rond |
| 166508 | 103 SPX   RCX | coudé rond |
| 2556   | MBK 51        | coudé rond |



2552



2553



166508



**TUN'R**

### GRILLE DE PROTECTION DÉCO 29X35CM

|        |               |
|--------|---------------|
| 486312 | orange        |
| 486311 | vert          |
| 441931 | noir          |
| 441930 | chrome        |
| 441929 | orange        |
| 461186 | blanc         |
| 441927 | bleu anodisé  |
| 441928 | rouge anodisé |



486312



486311



441931



441930



441929



461186

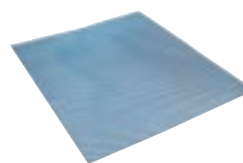

441927

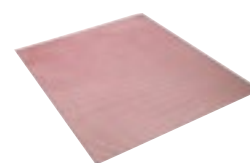

441928



## SELLE

482661 BOOSTER | BW'S 2004-> | noir



## HOUSSE DE SELLE

|        |                       |              |          |
|--------|-----------------------|--------------|----------|
| 381977 | BOOSTER   BW'S ->2003 | noir         |          |
| 382006 | BOOSTER   BW'S ->2003 | noir   blanc |          |
| 381966 | BOOSTER   BW'S ->2003 | blanc        |          |
| 476763 | BOOSTER   BW'S 2004-> | noir         |          |
| 476762 | BOOSTER   BW'S 2004-> | blanc        |          |
| 480455 | LUDIX                 | noir         | 2 places |
| 476765 | NEXT   ROCKET   NG    | blanc        |          |
| 480454 | NITRO   AEROX ->2013  | noir         |          |
| 480456 | SPEEDFIGHT 2          | noir         |          |
| 476760 | STUNT   SLIDER        | noir         |          |
| 476759 | STUNT   SLIDER        | blanc        |          |



Noir



Noir et blanc



Blanc



## HOUSSE DE SELLE

497437 BOOSTER | BW'S 2004->





**DOPPLER**

**HOUSSE DE SELLE**

|        |  |
|--------|--|
| 497438 | DERBI SENDA XTREME   X RACE   DRD   SMT   RCR 2012->               |
| 494024 | DERBI SENDA XTREME   X RACE ->2011   DRD ->2006   SMT   RCR ->2011 |



Sélection  
**CGN**

**SELLE**

|      |                            |      |
|------|----------------------------|------|
| 713  | 103 SP   MVL   SPX   VOGUE | noir |
| 4317 | MBK 51                     | noir |



713



4317



**SELLE AVEC TIGE DE SELLE**

|        |               |       |
|--------|---------------|-------|
| 167982 | grand prix    | noir  |
| 2926   | grand prix    | blanc |
| 209941 | magnum racing | noir  |



167982



2926



209941



## OPTIQUE



## OPTIQUE

|                |  | Homologué CE | Livré avec porte ampoule    | Livré avec ampoule             |
|----------------|--|--------------|-----------------------------|--------------------------------|
| <b>479161*</b> | BOOSTER   BW'S 2004-> type origine               | non          | non                         | non                            |
| <b>467897*</b> | NITRO   AEROX ->2013 (5BR)                       | non          | non                         | non                            |
| <b>481400*</b> | OVETTO   NEOS ->2007                             | non          | non                         | non                            |
| <b>484675*</b> | OVETTO   NEOS 2008->                             | non          | non                         | non                            |
| <b>479154</b>  | LUDIX BLASTER   SNAKE   TRENDY   ELEGANT         | oui          | oui (35/35W)<br>non (5W)    | oui (35/35W)<br>non (5W)       |
| <b>479153</b>  | LUDIX ONE   CLASSIC (762146)                     | oui          | oui                         | oui                            |
| <b>461537*</b> | STUNT   SLIDER ->2009   NACKED ->2005 (5JH)      | non          | oui                         | oui                            |
| <b>479149*</b> | STUNT   SLIDER NACKED 2005->   BOOSTER NG 1999-> | non          | non                         | non                            |
| <b>484676</b>  | FLY   LIBERTY                                    | oui          | oui                         | oui                            |
| <b>485922*</b> | SCOOTER CHINOIS                                  | non          | oui                         | oui                            |
| <b>479151</b>  | MACHG   JOG ->2002 (5RW)                         | oui          | oui<br>(ampoule principale) | oui (+ampoules<br>clignotants) |
| <b>488060</b>  | MBK EVOLIS 50                                    | oui          | non                         | non                            |
| <b>485977</b>  | VESPA LX 50   125                                | oui          | non                         | non                            |



479161



467897



481400



484675



479154



479153



461537



479149



484676



485922



479151



488060



485977

\*Produits destinés à des concours tuning, usage interdit sur la voie publique.



OPTIQUE

TUN'R

## DOUBLE OPTIQUE R8 HALOGÈNE 2X20W\*

|        |                       |                   |
|--------|-----------------------|-------------------|
| 475595 | BOOSTER   BW'S 2004-> | blanc             |
| 481825 | BOOSTER   BW'S 2004-> | blanc   noir      |
| 481824 | BOOSTER   BW'S 2004-> | noir mat   chrome |
| 475596 | BOOSTER   BW'S 2004-> | noir              |
| 477520 | BOOSTER   BW'S ->2003 | blanc             |
| 477521 | BOOSTER   BW'S ->2003 | noir              |
| 475811 | NITRO   AEROX ->2013  | blanc             |
| 475810 | NITRO   AEROX ->2013  | noir              |



475595



481825



481824



475596



477520



477521



475811



475810

TUN'R

## DOUBLE OPTIQUE HALOGÈNE 2X20W\*

|        |                              |                                  |
|--------|------------------------------|----------------------------------|
| 451329 | BOOSTER ROCKET   NEXT        | blanc LEDs bleues                |
| 451328 | BOOSTER ROCKET   NEXT        | noir LEDs bleues                 |
| 487897 | BOOSTER ROCKET   NEXT        | transparent LEDs bleues          |
| 465486 | BOOSTER SPIRIT   BW'S ->2003 | blanc 4 halogènes (2x15W + 2x5W) |
| 475845 | SPEEDFIGHT 2                 | noir 4 halogènes (2x15W + 2x5W)  |



451329



451328



487897



465486



475845

\*Produits destinés à des concours tuning, usage interdit sur la voie publique.



## OPTIQUE



## DOUBLE OPTIQUE\*

|        |                                   |                       |
|--------|-----------------------------------|-----------------------|
| 460397 | BOOSTER   BW'S 2004->             | noir                  |
| 460396 | BOOSTER   BW'S 2004->             | blanc                 |
| 364281 | BOOSTER NG ->1999   ROCKET   NEXT | noir halogènes 2x20W  |
| 364349 | NITRO   AEROX ->2013              | noir halogènes 2x20W  |
| 364334 | NITRO   AEROX ->2013              | blanc halogènes 2x20W |



460397



460396



364281



364349



364334



## DOUBLE OPTIQUE EVOLUTION\*

|        |                              |       |
|--------|------------------------------|-------|
| 374289 | BOOSTER SPIRIT   BW'S ->2004 | noir  |
| 374274 | BOOSTER SPIRIT   BW'S ->2004 | blanc |



374289



374274



## DOUBLE OPTIQUE MICROIQUE RX V2\*

|        |                       |       |
|--------|-----------------------|-------|
| 481294 | BOOSTER   BW'S 2004-> | noir  |
| 481293 | BOOSTER   BW'S 2004-> | blanc |



481294



481293



## BULLE OPTIQUE JAUNE

|        |                              |
|--------|------------------------------|
| 332894 | BOOSTER SPIRIT   BW'S ->2004 |
|--------|------------------------------|





## OPTIQUE



## DOUBLE OPTIQUE\*

|        |                    |                      |
|--------|--------------------|----------------------|
| 480251 | DERBI SENDA ->2008 | blanc LEDs blanches  |
| 480250 | DERBI SENDA ->2008 | noir LEDs blanches   |
| 480252 | DERBI SENDA ->2008 | chrome LEDs blanches |
| 475845 | XR6 2001->         | noir 4 halogènes     |



480251



480250



480252



475845



## OPTIQUE\*

|        |                             |                              |        |
|--------|-----------------------------|------------------------------|--------|
| 487616 | 103 MVL   VOGUE   CHRONO    | complet 12V                  | chrome |
| 487617 | 103 VOGUE   MVL   CHRONO    | complet 12V                  | noir   |
| 784    | 103 VOGUE   MVL   SPX   RCX | seul avec lampe 15W          |        |
| 487615 | MBK 88/51/41/881            | seul                         |        |
| 487613 | MBK 88/51/41/881            | complet 12V                  | bleu   |
| 487612 | MBK 88/881/51/41            | complet livré avec lampe 15W | noir   |
| 479158 | FOX (729564)                | homologué CE                 |        |
| 481627 | CIAO                        |                              |        |
| 3319   | CIAO                        |                              |        |



487616



487617



784



487615



487613



487612



479158



481627



3319



## OPTIQUE CHROME\*

|      |             |
|------|-------------|
| 2667 | rectangle   |
| 2669 | rond Ø130mm |



2667



2669





## OPTIQUE

### OPTIQUE HALOGENE ORIENTABLE NOIR HOMOLOGUE CE

|        |        |                                  |
|--------|--------|----------------------------------|
| 482968 | 12V35W | Ø52mm longueur 69mm hauteur 64mm |
| 482969 | 12V35W | rectangle                        |



482968



482969



### OPTIQUE LENTILLE LOUPE ORIENTABLE CHROME\*

|        |        |       |
|--------|--------|-------|
| 482970 | 12V55W | Ø55mm |
|--------|--------|-------|



### ÉCLAIRAGE ADDITIONNEL HALOGENE\*

|        |         |        |       |                         |
|--------|---------|--------|-------|-------------------------|
| 441886 | noir    | 12V20W | Ø35mm | orientable              |
| 482965 | noir    | 12V20W | Ø50mm | orientable              |
| 441885 | carbone | 12V20W | Ø35mm | orientable              |
| 482966 | carbone | 12V20W | Ø50mm | orientable              |
| 488146 | blanc   | 12V20W | Ø35mm | orientable              |
| 482967 | blanc   | 12V20W | Ø50mm | orientable              |
| 475843 | noir    |        | Ø35mm | spécial tête de fourche |



441886



482965



441885



482966



488146



482967



475843



### ÉCLAIRAGE DE PLAQUE

|        |                     |                    |
|--------|---------------------|--------------------|
| 479229 | *3LEDs              | noir   transparent |
| 466090 | 4 LEDs homologué CE | blanc              |
| 489444 | 4 LEDs homologué CE | noir               |



479229





466090



489444

### CASQUETTE PHARE

|        |                                   |   |
|--------|-----------------------------------|---|
| 2747   | 103 MVL   VOGUE projecteur chrome |  |
| 481751 | 103   MBK projecteur rond chrome  |  |



2747



481751

\*Produits destinés à des concours tuning, usage interdit sur la voie publique.



## CLIGNOTANT

## BOOSTER | BW'S



451904\*



avant

BOOSTER SPIRIT | BW'S ->2004  
noir/orange

451351



avant

BOOSTER | BW'S 2004-> ovale  
noir/transparent

468850



avant droit

BOOSTER | BW'S 2004-&gt;



468849



avant gauche

BOOSTER | BW'S 2004-&gt;



461620



avant

BOOSTER | BW'S 2004->  
carbone/transparent

484718



arrière

BOOSTER 13"



451353



arrière

BOOSTER | BW'S 2004-> ovale  
noir/transparent

468848



arrière droit

BOOSTER 2004-&gt;



468847



arrière gauche

BOOSTER 2004-&gt;



461621



arrière

BOOSTER | BW'S 2004->  
carbone/transparent

## NITRO | AEROX



484718



arrière

NITRO | AEROX 2013-&gt;



484716\*



avant

NITRO | AEROX 2013-&gt;



365269



arrière

NITRO | AEROX ->2013 noir/  
orange

365292\*



paire

NITRO | AEROX ->2013 carbone/  
orange



## CLIGNOTANT

## OVETTO | NEOS



484680\*



avant droit

OVETTO | NEOS 2008-&gt;



484681



avant gauche

OVETTO | NEOS 2008-&gt;

## STUNT | SLIDER

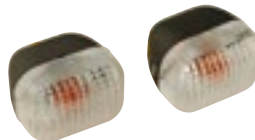

480371\*



avant, arrière

STUNT | SLIDER 2004 -&gt;

## FACT CPI | KEEWAY



485910



avant

KEEWAY F-ACT | FOCUS |  
MATRIX | RY8

485911



arrière

KEEWAY F-ACT | FOCUS |  
MATRIX | RY8

## LUDIX



461622



LUDIX carbone/transparent



481383



LUDIX noir/transparent

## TREKKER



292278\*



TREKKER/TKR AR noir/orange

## LIBERTY



485983\*



avant droit

LIBERTY 50 | 12 type origine



485982\*



avant gauche

LIBERTY 50 | 12 type origine



## CLIGNOTANT

## TYPHOON | SR MOTARD



484718



avant arrière

TYPHOON | SR MOTARD 2011-&gt;

## VESPA LX



485979



avant droit

VESPA LX type origine



485978



avant gauche

VESPA LX type origine



485981



arrière droit

VESPA LX type origine



485980



arrière gauche

VESPA LX type origine

## ZIP



483645\*



avant droit

ZIP 2001-&gt; type origine



483644\*



avant gauche

ZIP 2001-&gt; type origine



481820\*



avant

ZIP 2001-> chrome  
18 LEDs

481821\*



arrière

ZIP 2001-> chrome  
13 LEDs  
B: 223mm | C: 60mm

## SCOOTER CHINOIS



468850



avant droit

SCOOTER CHNOIS 4 temps  
50CC QT9 12"

468849



avant gauche

SCOOTER CHNOIS 4 temps  
50CC QT9 12"

468848



arrière droit

BOOSTER 2004-&gt;



468847



arrière gauche

BOOSTER 2004-&gt;



## CLIGNOTANT



## CABOCHON DE CLIGNOTANT

## Avant et arrière

|                |                      |        |    |
|----------------|----------------------|--------|----|
| <b>440126*</b> | BOOSTER NG 1999->    | orange | x4 |
| <b>451895*</b> | BOOSTER ROCKET   NG  | orange | x4 |
| <b>451899*</b> | OVETTO   NEOS ->2008 | orange | x4 |
| <b>291889*</b> | TREKKER   SQUAB      | orange | x4 |
| <b>451901*</b> | VIVACITY ->2008      | orange | x4 |
| <b>292699</b>  | STALKER homologué CE | orange | x4 |

## Avant

|                |                                |             |    |
|----------------|--------------------------------|-------------|----|
| <b>484717*</b> | NITRO   AEROX 2013->           | transparent | x2 |
| <b>248587*</b> | TYPHOON ->2006   NRG MC1   MC2 | orange      | x2 |
| <b>487747</b>  | LIBERTY 50 homologué CE        | orange      | x2 |

## Arrière

|                |                                |        |    |
|----------------|--------------------------------|--------|----|
| <b>245577*</b> | TYPHOON 2006->2009   NRG MC1   | orange | x2 |
| <b>487748</b>  | LIBERTY 50 ORANGE homologué CE | orange | x2 |



## CABOCHON DE CLIGNOTANT AVANT+ARRIÈRE TRANSPARENTS

|                |  |    |
|----------------|--|----|
| <b>459812</b>  | BOOSTER   BW'S 2004-> homologué CE     | x4 |
| <b>265017*</b> | BOOSTER NG ->1998   ROCKET gros modèle | x4 |
| <b>292657*</b> | BOOSTER. NG 1999->                     | x4 |
| <b>441288*</b> | BOOSTER. SPIRIT   BW'S->1998           | x4 |
| <b>291970*</b> | BOOSTER   BW'S 1999->2003              | x4 |
| <b>480764*</b> | NITRO   AEROX 1999->2013               | x4 |
| <b>319473*</b> | NITRO   AEROX 1999->2013               | x4 |
| <b>277002*</b> | OVETTO   NEOS ->2008                   | x4 |
| <b>291893*</b> | TREKKER   SQUAB   BOOSTER NACKED       | x4 |
| <b>277017*</b> | SPEEDFIGHT 1 et 2                      | x4 |
| <b>480357*</b> | TKR                                    | x4 |
| <b>265036</b>  | BUXY   ZENIT   SPEEDAKE                | x4 |



\*Produits destinés à des concours tuning, usage interdit sur la voie publique.



## CLIGNOTANT



## CABOCHON DE CLIGNOTANT AVANT+ARRIÈRE TRANSPARENTS

|         |  |    |
|---------|--|----|
| 376846  | VIVACITY ->2008  | x4 |
| 265055* | TYPHOON ->2006   NRG MC1                                   | x4 |
| 472619* | TYPHOON 2006->2009   | x4 |
| 480356  | LUDIX   TKR FURIOUS homologué CE                           | x4 |
| 481819* | ZIP 2001-> SMOOTH  | x4 |
| 481818* | ZIP 2001->   | x4 |
| 292703* | STALKER  | x4 |
| 489986* | NRG MC2   MC3 1999->                                       | x4 |
| 292039* | STUNT   SLIDER   | x4 |
| 480765* | LUDIX   TKR FURIOUS  | x4 |
| 480466* | DERBI SENDA   BETA RR                                      | x4 |
| 480765* | LUDIX   TKR FURIOUS  | x4 |
| 484721* | NITRO 2013->   BOOSTER 13"   TYPHOON<br>2011->   SR MOTARD |    |



376846



265055



472619



480356



481819



481818



292703



489986



292039



480765



480466



480765



484721



## CENTRALE CLIGNOTANT

|        |                                   |     |       |          |
|--------|-----------------------------------|-----|-------|----------|
| 487057 | BOOSTER   BW'S 1999->2004         | 12V | 2x10W | 2 fiches |
| 450777 | BOOSTER   BW'S   BUXY   FOX       | 12V | 2x10W | 4 fiches |
| 486284 | OVETTO   NEOS 2 temps             | 12V | 2x6W  | 2 fiches |
| 450779 | PIAGGIO 50   125   BOOSTER 2004-> | 12V | 2x10W | 2 fiches |

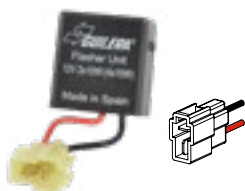

487057



450777

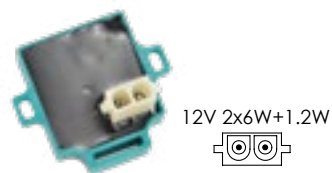

486284

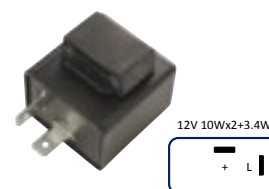

450779

\*Produits destinés à des concours tuning, usage interdit sur la voie publique.



## CLIGNOTANT



### CENTRALE CLIGNOTANT

|               |                                       |              |       |          |
|---------------|---------------------------------------|--------------|-------|----------|
| <b>482180</b> | NITRO   AEROX   BOOSTER   BW'S ->2004 | 12V          | 2x10W | 2 fiches |
| <b>485179</b> | BOOSTER   BW'S   NITRO   AEROX        | 12V avec buz | 2x10W | 2 fiches |
| <b>484656</b> | OVETTO   NEOS 2 temps                 | 12V          | 2x6W  | 2 fiches |
| <b>490086</b> | TYPHOON   STALKER                     | 12V          | 2x10W | 2 fiches |
| <b>480763</b> | KYMCO 50CC PEUGEOT 3 cosses           |              |       |          |



482180



485179



484656

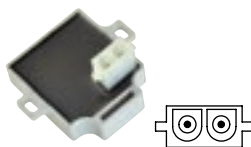

490086



480763



### CENTRALE CLIGNOTANT

**450778** TYPHOON | NRG | STALKER | DNA | ZIP | SR50 2005->



## CLIGNOTANT AVANT ET ARRIERE



365292\*



DERBI SENDA | BETA RR  
carbone/orange



481382\*



DERBI SENDA | BETA RR noir/  
transparent



365269\*



DERBI SENDA | BETA RR noir/  
transparent



484718



RS4 | GPR 2010->



461622



XP6 | XPS | XR6 carbone/  
transparent



481383



XP6 | XPS | XR6 noir/transparent

\*Produits destinés à des concours tuning, usage interdit sur la voie publique.



## CLIGNOTANT AVANT ET ARRIÈRE



## CABOCHON DE CLIGNOTANT AVANT ET ARRIÈRE

|         |               |        |    |
|---------|---------------|--------|----|
| 291889* | SENDA L   XP6 | orange | x4 |
|---------|---------------|--------|----|



## CABOCHON DE CLIGNOTANT AVANT+ARRIÈRE TRANSPARENTS

|         |                              |  |    |
|---------|------------------------------|--|----|
| 291893* | XP6   SENDA   TZR ->2004     |  | x4 |
| 480356  | XP6   XPS   XR6 homologué CE |  | x4 |



291893



480356



## CABOCHON DE CLIGNOTANT TRANSPARENT (X4)

|        |                            |
|--------|----------------------------|
| 480356 | XP6   XPS   XR6            |
| 291893 | XP6   SENDA L   TZR ->2004 |



480356



291893



## CABOCHON DE CLIGNOTANT TRANSPARENT (X2)

|         |           |
|---------|-----------|
| 484721* | RS4   GPR |
|---------|-----------|



## CENTRALE DE CLIGNOTANT

|        |  |     |             |
|--------|--|-----|-------------|
| 486288 | AM6   SHERCO                             | 12V | 2x(4x2.3)W  |
| 486292 | RIEJU SMX   MRX   SPIKE   RR             | 12V | 2x10W       |
| 486285 | X-POWER   TZR 2004->                     | 12V | 10+16W      |
| 486287 | XR7   XP7   XPS   MH RX50R   RYZ   FURIA | 12V | 2x10(4x10)W |
| 494309 | BETA RR 2007->                           | 12V | 6W+6W+1.2W  |



486288

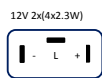

486292



486285



486287

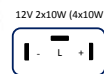

494309







CLIGNOTANT AVANT ET ARRIÈRE



CABOCHON DE CLIGNOTANT

450105 orange avant+arrière wallaroo x4



CLIGNOTANT À AMPOULE



477478

AMBIANCE noir/transparent homologué CE

↪ B: 63mm



489443

BLINKER carbone/fumé homologué CE

↪ Type d'ampoule: BA95  
 ↪ Culot: ergot  
 ↪ Puissance: 10W  
 ↪ A: 20mm | B: 68mm | C: 23mm



489442

BLINKER noir rubber/fumé homologué CE

↪ Type d'ampoule: BA95  
 ↪ Culot: ergot  
 ↪ Puissance: 10W  
 ↪ A: 20mm | B: 68mm | C: 23mm



441305\*

ARROW carbone/orange

↪ Type d'ampoule: BA95  
 ↪ Culot: ergot  
 ↪ Puissance: 21W  
 ↪ A: 20mm | B: 85mm | C: 28mm



477477

RUBIS noir/transparent homologué CE

↪ Type d'ampoule: BA95  
 ↪ Culot: ergot  
 ↪ Puissance: 6W  
 ↪ A: 20mm | B: 58mm | C: 26mm



487544

INDICATOR noir/transparent homologué CE

↪ Type d'ampoule: BA95  
 ↪ Culot: ergot  
 ↪ Puissance: 10W  
 ↪ A: 20mm | B: 68mm | C: 27mm



487546

INDICATOR carbone/transparent homologué CE

↪ Type d'ampoule: BA95  
 ↪ Culot: ergot  
 ↪ Puissance: 10W  
 ↪ A: 20mm | B: 68mm | C: 28mm



441881\*

OVAL micro fixation courte carbone/transparent

↪ Type d'ampoule: BA95  
 ↪ Culot: ergot  
 ↪ Puissance: 23W  
 ↪ A: 20mm | B: 77mm | C: 27mm

\*Produits destinés à des concours tuning, usage interdit sur la voie publique.



## TUN'R CLIGNOTANT À AMPOULE

|  |   |  |   |
|--|---|--|---|
|  |   |  |   |
| <p><b>487557</b></p> <p>MINI TRIANGLE noir/transparent homologué CE</p> <p>↳ <b>Type d'ampoule:</b> BA95</p> <p>↳ <b>Culot:</b> ergot</p> <p>↳ <b>Puissance:</b> 5W</p> <p>↳ <b>A:</b> 20mm   <b>B:</b> 64mm   <b>C:</b> 26mm</p>        | <p><b>451417</b></p> <p>TRIANGLE fixation courte noir/transparent homologué CE</p> <p>↳ <b>Type d'ampoule:</b> BA95</p> <p>↳ <b>Culot:</b> ergot</p> <p>↳ <b>Puissance:</b> 21W</p> <p>↳ <b>A:</b> 20mm   <b>B:</b> 78mm   <b>C:</b> 38mm</p> | <p><b>480272*</b></p> <p>TRIANGLE fixation courte blanc/transparent</p> <p>↳ <b>Type d'ampoule:</b> BA95</p> <p>↳ <b>Culot:</b> ergot</p> <p>↳ <b>Puissance:</b> 21W</p> <p>↳ <b>A:</b> 20mm   <b>B:</b> 78mm   <b>C:</b> 38mm</p>             | <p><b>451339</b></p> <p>TRIANGLE fixation courte noir/transparent homologué CE</p> <p>↳ <b>Type d'ampoule:</b> BA95</p> <p>↳ <b>Culot:</b> ergot</p> <p>↳ <b>Puissance:</b> 21W</p> <p>↳ <b>A:</b> 20mm   <b>B:</b> 83mm   <b>C:</b> 37mm</p>       |
|  |   |  |   |
| <p><b>480363</b></p> <p>MICRO TRIANGLE blanc/orange homologué CE</p> <p>↳ <b>Type d'ampoule:</b> BA95</p> <p>↳ <b>Culot:</b> ergot</p> <p>↳ <b>Puissance:</b> 6W</p> <p>↳ <b>A:</b> 20mm   <b>B:</b> 54mm   <b>C:</b> 20mm</p>           | <p><b>473397</b></p> <p>MICRO TRIANGLE carbone/orange homologué CE</p> <p>↳ <b>Type d'ampoule:</b> BA95</p> <p>↳ <b>Culot:</b> ergot</p> <p>↳ <b>Puissance:</b> 6W</p> <p>↳ <b>A:</b> 20mm   <b>B:</b> 54mm   <b>C:</b> 20mm</p>              | <p><b>473396</b></p> <p>MICRO TRIANGLE noir/orange homologué CE</p> <p>↳ <b>Type d'ampoule:</b> BA95</p> <p>↳ <b>Culot:</b> ergot</p> <p>↳ <b>Puissance:</b> 6W</p> <p>↳ <b>A:</b> 20mm   <b>B:</b> 54mm   <b>C:</b> 20mm</p>                  | <p><b>449942*</b></p> <p>TRIANGLE fixation courte carbone/transparent ampoule orange</p> <p>↳ <b>Type d'ampoule:</b> BA95</p> <p>↳ <b>Culot:</b> ergot</p> <p>↳ <b>Puissance:</b> 21W</p> <p>↳ <b>A:</b> 20mm   <b>B:</b> 78mm   <b>C:</b> 37mm</p> |
|  |   |  |   |
| <p><b>451346</b></p> <p>PYRAMID fixation courte noir/orange homologué CE</p> <p>↳ <b>Type d'ampoule:</b> BA155</p> <p>↳ <b>Culot:</b> ergot</p> <p>↳ <b>Puissance:</b> 10W</p> <p>↳ <b>A:</b> 16mm   <b>B:</b> 73mm   <b>C:</b> 35mm</p> | <p><b>475317</b></p> <p>PYRAMID fixation courte noir/transparent homologué CE</p> <p>↳ <b>Type d'ampoule:</b> BA155</p> <p>↳ <b>Culot:</b> ergot</p> <p>↳ <b>Puissance:</b> 10W</p> <p>↳ <b>A:</b> 20mm   <b>B:</b> 73mm   <b>C:</b> 35mm</p> | <p><b>462144</b></p> <p>OVAL micro fixation courte carbone brillant/transparent</p> <p>↳ <b>Type d'ampoule:</b> BA95</p> <p>↳ <b>Culot:</b> ergot</p> <p>↳ <b>Puissance:</b> 21W</p> <p>↳ <b>A:</b> 20mm   <b>B:</b> 70mm   <b>C:</b> 30mm</p> | <p><b>462145</b></p> <p>OVAL micro fixation courte carbone mat/transparent</p> <p>↳ <b>Type d'ampoule:</b> BA95</p> <p>↳ <b>Culot:</b> ergot</p> <p>↳ <b>Puissance:</b> 21W</p> <p>↳ <b>A:</b> 20mm   <b>B:</b> 70mm   <b>C:</b> 30mm</p>           |



## TUN'R CLIGNOTANT À AMPOULE



**458486**

OVAL micro fixation courte noir/  
orange homologué CE

↳ **Type d'ampoule:** BA95

↳ **Culot:** ergot

↳ **Puissance:** 21W

↳ **A:** 20mm | **B:** 70mm | **C:** 30mm



**281642\***

RECTANGLE mini fixation courte  
carbone/orange

↳ **Type d'ampoule:** BA95

↳ **Culot:** ergot

↳ **Puissance:** 23W

↳ **A:** 17mm | **B:** 75mm | **C:** 39mm



**327793\***

RECTANGLE mini fixation courte  
carbone/orange/transparent  
+ampoules oranges

↳ **Type d'ampoule:** BA95

↳ **Culot:** ergot

↳ **Puissance:** 23W

↳ **A:** 18mm | **B:** 82mm | **C:** 38mm



**440127\***

RECTANGLE mini courte noir/  
transparent

↳ **Type d'ampoule:** BA95

↳ **Culot:** ergot

↳ **Puissance:** 23W

↳ **A:** 19mm | **B:** 85mm | **C:** 38mm

## TUN'R CLIGNOTANT À LEDS



**487559**

SMARTNESS noir/fumé  
homologué CE

↳ **A:** 20mm | **C:** 19mm



**490082**

SMARTNESS noir

↳ **feux:** arrière, stop, clignotants

↳ **A:** 20mm | **B:** 81mm | **C:** 18mm



**490081**

SMARTNESS noir RUBBER

↳ **feux:** arrière, stop, clignotants

↳ **A:** 20mm | **B:** 81mm | **C:** 18mm



**487551**

ARROW noir/transparent  
homologué CE

↳ 12 LEDs

↳ **A:** 20mm | **B:** 86mm | **C:** 28mm



## TUN'R CLIGNOTANT À LEDS

|  |  |  |   |
|--|--|--|---|
|  |  |  |   |
| <p><b>488145</b></p> <p>MYGHTY noir/transparent corps alu</p> <p>↪ A:20mm   B: 49mm   C:22mm</p>                               | <p><b>489441</b></p> <p>MINI WINKER carbone/transparent homologué CE</p> <p>↪ 8 LEDs</p> <p>↪ A:20mm   B: 55mm   C: 20mm</p> | <p><b>480680</b></p> <p>MINI WINKER noir/transparent homologué CE</p> <p>↪ 8 LEDs</p> <p>↪ A:20mm   B: 55mm   C:20mm</p>   | <p><b>480681</b></p> <p>MINI WINKER blanc/transparent homologué CE</p> <p>↪ 8 LEDs</p> <p>↪ A:20mm   B: 55mm   C:20mm</p> |
|  |  |  |   |
| <p><b>487555</b></p> <p>MINI TRIANGLE carbone/transparent homologué CE</p> <p>↪ 12 LEDs</p> <p>↪ A:20mm   B: 64mm   C:26mm</p> | <p><b>487556</b></p> <p>MINI TRIANGLE noir/transparent homologué CE</p> <p>↪ 12 LEDs</p> <p>↪ A:20mm   B: 64mm   C:26mm</p>  | <p><b>487549</b></p> <p>INDICATOR carbone/transparent homologué CE</p> <p>↪ 12 LEDs</p> <p>↪ A:20mm   B: 67mm   C:28mm</p> | <p><b>487548</b></p> <p>INDICATOR noir/transparent homologué CE</p> <p>↪ 12 LEDs</p> <p>↪ A:20mm   B: 67mm   C:28mm</p>   |
|  |  |  |   |
| <p><b>484974*</b></p> <p>OVAL argent cabochon transparent</p> <p>↪ 7 LEDs</p> <p>↪ A: 15mm   B: 95mm   C:20mm</p>              | <p><b>480678</b></p> <p>VECTOR noir/transparent</p> <p>↪ 6 LEDs</p> <p>↪ A:20mm   B: 64mm   C:18mm</p>                       | <p><b>472440</b></p> <p>MICRO noir/transparent homologué CE</p> <p>↪ A:13mm   B: 28mm   C:18mm</p>                         | <p><b>478903</b></p> <p>UNIVERSEL BARRETTE transparent homologué CE</p> <p>↪ 8 LEDs</p> <p>↪ B: 61mm   C: 8mm</p>         |

\*Produits destinés à des concours tuning, usage interdit sur la voie publique.



## TUN'R CLIGNOTANT À AMPOULE



**484973\***

SNAKE argent cabochon transparent

↪ A:15mm | B:73mm | C:25mm



**475315**

TRIANGLE fixation courte carbone/transparent homologué CE

↪ 13 LEDs  
↪ A:20mm | B: 79mm | C:37mm



**475316**

TRIANGLE fixation courte noir/transparent homologué CE

↪ 13 LEDs  
↪ A:20mm | B:79mm | C:37mm



**493091**

DASHER SMD avec feu stop intégré livré sans fixation



**493084**

SMART SMD avec feu de position intégré



**493086**

SMART SMD avec feu stop intégré



**494384\***

REAPER noir et fumé



**494383\***

SMOGG noir et fumé



### CENTRALE DE CLIGNOTANT UNIVERSELLE

**480370** 2 fils spéciaux pour clignotants 12V 0.05-10A pour LED



### CENTRALE DE CLIGNOTANT UNIVERSELLE

**477500** 2 fils pour LED 10W maximum

**458483** 2 fils 0.1-25A

**458484** 3 fils 0.1-25A



477500



458483



458484

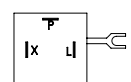
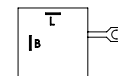
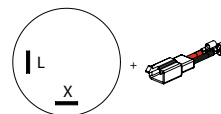

\*Produits destinés à des concours tuning, usage interdit sur la voie publique.



CLIGNOTANT À AMPOULE



CENTRALE DE CLIGNOTANT UNIVERSELLE

491059 2 fils pour LED 0.1-25A

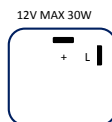

RÉSISTANCE DE CLIGNOTANT (X2)

468228 avec connectique 12 Ohms pour 10W

480682 avec connectique 10 Ohms pour 21W

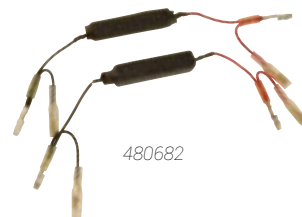

FEU ARRIÈRE

BOOSTER | BW'S 2004->



459998



tansparent lampe rouge



472614\*



type LEXUS black



460861\*



type LEXUS transparent



482481



fumé homologué CE  
clignotant intégré



475880\*



noir/transparent à LEDs



476281\*



avec clignotants intégrés

BOOSTER | BW'S 1999->2003



317231\*



rouge avec clignotant orange



459758\*



transparent type LEXUS



472612\*



noir type LEXUS



440078



transparent

\*Produits destinés à des concours tuning, usage interdit sur la voie publique.



FEU ARRIÈRE

BOOSTER ->1999



188706\*



rouge avec clignotant



440077\*



transparent

BOOSTER NG | ROCKET | NEXT



472610\*



type LEXUS black

BOOSTER RX ->2004



483491



noir ailettes noires

NITRO | AEROX 2013 ->



484719\*



NITRO | AEROX | OLIVER | KEWAY ->2013



482483



à LEDs clignotants intégrés



451319\*



transparent



475881\*



noir à LEDs



475413



blanc à LEDs avec ailettes



475414



noir à LEDs avec ailettes



481290



pièce détachée feu RX 475414  
475413



477296



transparent



482992



blanc lait

\*Produits destinés à des concours tuning, usage interdit sur la voie publique.



## FEU ARRIÈRE

NITRO | AEROX |  
OLIVER | KEEWAY ->2013

OVETTO | NEOS 2008-> OVETTO | NEOS ->2008



477767

à LEDs avec éclairage plaque



485975\*

transparent



454982

transparent type LEXUS

## LUDIX



484209\*

rouge



461594\*

transparent type LEXUS



472617\*

noir type LEXUS



482996\*

blanc lait 15 LEDs

## STUNT | SLIDER | RS1 | ARK



489979\*

rouge



472613\*

noir type LEXUS



454984\*

transparent type LEXUS



476280

transparent à LEDs



475883\*

noir/transparent à LEDs



482993\*

blanc lait 15 LEDs





FEU ARRIÈRE

SPEEDFIGHT 2



450089\*



rouge



472504



transparent LEDs

SCOOTER CHINOIS |  
V-CLIC 50CC | QT3 | 10"  
4 TEMPS



468841



transparent/rouge

ZIP 2001->



483288



fumé chrome à LEDs



481822



transparent type LEXUS



481823\*



transparent chrome à LEDs



491444\*



TREKKER | SQUAB | TKR



472616\*



type LEXUS blanc



451321\*



type LEXUS transparent

LIBERTY 50 | 125 2009->



484677\*



VESPA LX 50 | 125



485976\*



KEEWAY F-ACT |  
MATRIX | RY8



485914\*



VIVACITY ->2008



484678



\*Produits destinés à des concours tuning, usage interdit sur la voie publique.



## FEU ARRIÈRE

## ECLAIRAGE / LIGHTING

## FEU ARRIÈRE À LEDS TRANSPARENT



**TUN'R**

459996

NRG-MC2 | MC3

FEU ARRIÈRE À LEDS TRANSPARENT  
CLIGNOTANTS INTÉGRÉS

**TUN'R**

476282\*

APRILIA SR50 2005->



## CABOCHON DE FEU ARRIÈRE ROUGE

|         |                                  |       |
|---------|----------------------------------|-------|
| 254927* | BOOSTER NG   ROCKET   NEXT       | rouge |
| 461534* | BOOSTER   BW'S 2004->            | rouge |
| 484720* | NITRO   AEROX 2013->             | fumé  |
| 333321* | NITRO   51 MAGNUM   OLIVER       | rouge |
| 333628* | OVETTO   NEOS ->2008             | rouge |
| 489980* | STUNT   SLIDER   RS1   ARK       | rouge |
| 451907* | TREKKER   SQUAB   TKR            | rouge |
| 461823* | LUDIX                            | rouge |
| 451908* | VIVACITY ->2008                  | rouge |
| 213405* | TYPHOON ->2011   STORM   NRG MC1 | rouge |
| 376645* | STALKER                          | rouge |
| 487749  | LIBERTY 50                       | rouge |
| 480457* | ZIP 2001->                       | rouge |



254927



461534



484720



333321



333628



489980



451907



461823



451908



213405



376645



487749



480457

\*Produits destinés à des concours tuning, usage interdit sur la voie publique.



## FEU ARRIÈRE



## CABOCHON DE FEU ARRIÈRE TRANSPARENT

|                |  |
|----------------|--|
| <b>327702*</b> | BOOSTER SPIRIT   BW'S 1999->2003                 |
| <b>327717*</b> | BOOSTER SPIRIT ->1999   BW'S ->1999              |
| <b>333211*</b> | BOOSTER NG   ROCKET   NEXT                       |
| <b>480771*</b> | BOOSTER   BW'S 1999->2003 lisse avec clignotants |
| <b>482535*</b> | BOOSTER   BW'S 2004-> lisse                      |
| <b>333336*</b> | NITRO   51 MAGNUM   OLIVER                       |
| <b>480770*</b> | TUNT   SLIDER   RS1   ARK                        |
| <b>465812*</b> | STUNT   SLIDER   RS1   ARK                       |
| <b>333977*</b> | TREKKER   SQUAB   TKR                            |
| <b>461824*</b> | LUDIX  |
| <b>376884</b>  | VIVACITY ->2008                                  |
| <b>480358*</b> | ZIP 2001->                                       |



## DERBI SENDA DRD | X-TREME | RIEJU RS2 | XR7 | XP7 | NK7



466094



transparent



482479\*



à LEDs clignotants intégrés



482997



blanc lait

## DERBI SENDA R-XTREM | SM-XTREM 2001-&gt;2003



461627



transparent



467862\*



transparent type Lexus

## HONDA DAX



478258\*



blanc à LEDs avec éclairage de plaque



## FEU ARRIÈRE

## DERBI SENDA | XP6 | XR6 | X-LIMIT -&gt;2002 | F12 | TZR



479956\*



rouge type origine

## RS50-&gt;1998 | GPR 2002-&gt;2004



482483



à LEDs clignotants intégrés



451319\*



transparent



475881\*



noir à LEDs



475413



blanc à LEDs avec ailettes



475414



noir à LEDs avec ailettes



481290

pièce détachée feu RX 475414  
475413

477296



transparent



482992



blanc lait



477767



à LEDs avec éclairage plaque



## FEU ARRIÈRE

### MRT



490446



à LEDs



486155



ovale fumé à LEDs  
FACTORY



459797



ovale transparent à LEDs  
FACTORY

### TUN'R BETA RR



490354

BETA RR



490445

BETA RR clignotant intégré



467864

BETA RR



467865

BETA RR



### CABOCHON DE FEU ARRIÈRE

336005\* F12 | XP6 | XR6 | SENDA | X-LIMIT ->2002 | TZR



### CABOCHON DE FEU ARRIÈRE

376903\* XP6 | XR6 | SENDA | X-LIMIT ->2002 | TZR transparent

480769\* XP6 | XR6 | SENDA | X-LIMIT ->2002 | TZR lisse



376903



480769



### FEU ARRIÈRE UNIVERSEL FOGGY MINI

493088 avec éclairage de plaque fumé

493089 avec éclairage de plaque rouge



493088



493089

\*Produits destinés à des concours tuning, usage interdit sur la voie publique.

**TUN'R** FEU UNIVERSEL

|   |   |  |   |
|---|---|--|---|
|    |    |    |    |
| <b>282763*</b><br>cross rouge/noir  | <b>485973</b><br>fumé MINI avec éclairage de plaque                                 | <b>288977*</b><br>sur platine argent double rond rouge                               | <b>441297*</b><br>type XR rouge   |
|    |    |    |    |
| <b>450108*</b><br>type XR transparent   | <b>483393</b><br>fumé 6 LEDs  | <b>483392</b><br>transparent à 6 LEDs  | <b>482480</b><br>à LEDs, fumé clignotant intégré                                      |
|   |   |   |   |
| <b>476284</b><br>transparent à LEDs clignotants intégrés                            | <b>480675</b><br>transparent à LEDs avec feu stop                                   | <b>486155</b><br>oval fumé à LEDs  | <b>459797</b><br>oval transparent à LEDs  |
|  |  |  |  |
| <b>486263*</b><br>oval transparent avec 9 LEDs                                      | <b>475842</b><br>MINI triangle à LEDs pour bavette 462566/462565                    | <b>478329</b><br>BARETTE transparent à LEDs  | <b>485974</b><br>noir avec éclairage plaque et feu stop                               |

**TUN'R** FEU UNIVERSEL FIXATION VERTICALE

|   |   |  |   |
|---|---|--|---|
|  |  |  |  |
| <b>490354</b><br>fumé à LEDs  | <b>490445</b><br>fumé à LEDs clignotant intégré                                     | <b>467864</b><br>rouge à LEDs  | <b>467865</b><br>transparent à LEDs   |

\*Produits destinés à des concours tuning, usage interdit sur la voie publique.

**TUN'R**

## FEU ARRIÈRE INTÉGRÉ À LEDS NE SUPPORTANT PAS DE PLAQUE

**462565**

rouge à LEDs

**462566**

transparent à LEDs avec bavette

**467863**

rouge à LEDs avec bavette

**485972**

rouge à LEDs

**496106**

fumé 6 LEDs

**496104**

rouge 6 LEDs

**496105**

transparent 6 LEDs

**TUN'R**

### SUPPORT DE PLAQUE ORIENTABLE

**487624**

aluminium noir



## FEU ARRIÈRE

**270323\***
**TUN'R**
103 RC | 51 S MBK  
carbone | transparent
**782\***
**TUN'R**
103 RC | 51 S MBK  
chrome | rouge
**781\***
**TUN'R**
103 RC | 51 S MBK  
noir | rouge
**270319\***
**TUN'R**
103 RC | 51 S MBK  
carbone | rouge
**780\***
**TEKNIX**
103 SPX | RCX AVEC  
CATADIOPTRÉS  
avec catadioptrés
**777\***
**TUN'R**
103  
chrome | rouge
**778\***
**TEKNIX**
103 ancien modèle  
noir
**779**
**TEKNIX**

103 MVL | VOGUE | MBK CLUB

\*Produits destinés à des concours tuning, usage interdit sur la voie publique.



FEU ARRIÈRE



3323\*



CIAO complet



450092\*



FOX | FXR  
rouge



4218\*



MBK hexagonal  
noir



CABOCHON DE FEU ARRIÈRE

378807\*

103 FOX | FXR

rouge



FEU DÉCORATIF 3M 18 LEDS BANDE DE 30CM



482315\*

blanc fixe



482314\*

bleu fixe



482318\*

orange fixe



482319\*

rose fushia fixe



482317\*

rouge fixe



482316\*

vert fixe



482320\*

violet fixe



FEU DÉCORATIF 3M 18 LEDS BANDE DE 30CM



480448

orange fixe

\*Produits destinés à des concours tuning, usage interdit sur la voie publique.





**BCD**

## FEU DÉCORATIF LEDLINE 6 LEDS BANDES ADHÉSIVES 15CM

**482803\*** blanc fixe



## TUN'R FEU DÉCORATIF



**218479\***

glide chrome et orange avec casquette



**2666\***

glide chrome et rouge avec casquette



**384601\***

yeux chats mini rond blanc



**480273\***

goutte d'eau micro autocollant blanc et transparent



**283258\***

goutte d'eau micro autocollant chrome transparent



**450460**

clignotant goutte d'eau mini autocollant fumé et carbone



**451409\***

goutte d'eau micro clips éclairage bleu



**451410\***

goutte d'eau micro clips éclairage bleu et carbone



**480361\***

goutte d'eau micro clips éclairage orange et blanc

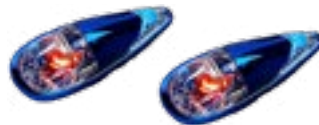

**451579\***

goutte d'eau micro clips éclairage orange et bleu



**451580\***

goutte d'eau micro clips éclairage orange et carbone



**451583\***

goutte d'eau micro clips éclairage orange et chrome



**451581\***

goutte d'eau micro clips éclairage orange et noir



**480362\***

goutte d'eau micro clips éclairage orange et rouge



**328819\***

goutte d'eau transparent et orange



**480360\***

goutte d'eau futur transparent et blanc

\*Produits destinés à des concours tuning, usage interdit sur la voie publique.



## TUN'R FEU DÉCORATIF



**473399\***

goutte d'eau futur transparent et carbone



**473398\***

goutte d'eau futur transparent et chrome



**480387\***

goutte d'eau futur transparent et or



**480384\***

goutte d'eau futur transparent et rouge



**480385\***

goutte d'eau futur transparent et vert



**480386\***

goutte d'eau futur transparent et bleu

## TUN'R

### NÉON TUBE

**458228\*** bulles bleues embouts bleus Ø12mm longueur 150mm

**458190\*** LEDs vertes embout chrome Ø10mm longueur 120mm

**484760\*** rouge avec transformateur 500mm

**484327\*** multicolor embouts chrome Ø10mm longueur 120mm



458228



458190



484760



484327





## Halogène S2 12V 35/35W BA20d : Avant première mondiale Osram

Plus lumineuse et faisceau plus précis  
Plus de performance pour plus de sécurité  
Durée de vie jusqu'à 4 fois plus longue

LAMPE | AMPOULE

12V 1.2W T5

**464934** témoin compteur W2x4.6d 

**371423** témoin compteur 

**484756** éclairage compteur bleu 

**484757** éclairage compteur rouge 

**483658** témoin compteur à LEDs rouges 

12V 1.7W T6.5

**490299** éclairage compteur blanc 

12V 3W T10

**384927** éclairage compteur blanc 

12V 5W T10

**464935** témoin compteur W2.1x9.5d culot de verre 

**481885** témoin compteur W2.1x9.5d culot de verre 

12V 5-21W T10

**384965** éclairage 



464934 371423 484756  
484757 483658 490299  
384927 464935 481885  
384965



LAMPE CLIGNOTANT

12V 10W

**269888\*** BOOSTER SPIRIT jaune x4

**269873\*** BOOSTER SPIRIT bleu x4

**333427\*** BOOSTER SPIRIT orange x4

**269869\*** BOOSTER SPIRIT vert x4

**269892\*** BOOSTER SPIRIT violet x4

**480269\*** BA15S 6 LEDs oranges x1

12V 21W + 12V 10W

**321412** BOOSTER NG orange 2x2

**321393** BOOSTER NG bleu 2x2

12V 21W

**450462\*** mini clignotant blanc x1

12V 23W

**487479\*** mini clignotant blanc x1







**450461\*** mini clignotant orange x1



269888 269873 333427 269869  
269892 480269 321412 321393  
450462 487479 450461

\*Produits destinés à des concours tuning, usage interdit sur la voie publique.

## LAMPE FEU, GRAISSEUR 6V

|        |        |          |   |
|--------|--------|----------|---|
| 461978 | BA9S   | 6V 4W    |  |
| 2731   | BA9S   | 6V 4W    |  |
| 461975 | BA15S  | 6V 10W   |  |
| 2734   | BA15S  | 6V 10W   |  |
| 487500 | BA15S  | 6V 21W   |  |
| 2722   | BAY15D | 6V 5-21W |  |
| 2707   | E10    | 6V 1,8W  |  |



## LAMPE FEU, GRAISSEUR 12V BA7S

487501 12V 2W



## LAMPE FEU, GRAISSEUR 12V BA9S

|        |                                |   |
|--------|--------------------------------|---|
| 2737   | 12V 4W témoin                  |   |
| 2735   | 12V 4W témoin                  |  |
| 333446 | 12V 4W témoin rouge            |  |
| 468216 | 12V 10W mini clignotant orange |  |
| 468215 | 12V 10W mini clignotant blanc  |  |
| 494326 | 12V 10W 9 LEDs blanc           |  |







## LAMPE FEU, GRAISSEUR 12V BA9S

|        |                                  |
|--------|----------------------------------|
| 468309 | 12V 10W orange ergo décalé       |
| 468310 | 12V 10W transparent ergot décalé |













## LAMPE FEU, GRAISSEUR 12V BAX9S

|        |         |  |   |
|--------|---------|--|---|
| 468218 | 12V 6W  | H6W mini clignotant orange ergot décalé  |  |
| 468217 | 12V 6W  | H6W mini clignotant blanc ergot décalé   |  |
| 450463 | 12V 21W | mini clignotant blanc long ergot décalé  |  |
| 450464 | 12V 21W | mini clignotant orange long ergot décalé |  |



LAMPE FEU, GRAISSEUR 12V BA15S

|         |         |                        |   |
|---------|---------|------------------------|---|
| 283554  | 12V 5W  | graisseur              |  |
| 491053  | 12V 5W  | graisseur              |  |
| 187604  | 12V 5W  | feu stop               |  |
| 2729    | 12V 10W | graisseur              |  |
| 489607  | 12V 10W | graisseur              |  |
| 489606  | 12V 10W | graisseur              |  |
| 468214  | 12V 10W | graisseur              |  |
| 2730    | 12V 10W | graisseur              |  |
| 494331+ | 12V 10W | à LEDs                 |  |
| 450661  | 12V 21W | clignotant et feu stop |  |
| 173487  | 12V 21W | feu stop blanc         |  |



LAMPE FEU, GRAISSEUR 12V BAU15S

|        |         |                                |   |
|--------|---------|--------------------------------|---|
| 465712 | 12V 10W | graisseur orange ergot décalé  |  |
| 464933 | 12V 21W | clignotant orange ergot décalé |  |
| 491055 | 12V 21W | clignotant orange ergo décalé  |  |
| 491054 | 12V 21W | clignotant orange              |  |
| 491056 | 12V 21W | clignotant                     |  |
| 468213 | 12V 21W | clignotant et feu stop         |  |



## LAMPE FEU, GRAISSEUR 12V BAY15D

|         |           |                               |   |
|---------|-----------|-------------------------------|---|
| 450109* | 12V 18/5W | feu stop blanc petit bulbe    | TUNER   |
| 365447* | 12V 18/5W | feu stop rouge petit bulbe    | TUNER   |
| 173635  | 12V 21/5W | feu/stop                      | OSRAM   |
| 486797  | 12V 21/5W | feu/stop                      |  |
| 2724    | 12V 21/5W | feu/stop                      | Selection CGN   |
| 487894  | 12V 21/5W | feu/stop bleu                 | Selection CGN   |
| 333431* | 12V 21/5W | feu/stop rouge                | TUNER   |
| 480271* | 12V 21/5W | feu arrière LEDs rouge/stop   | TUNER   |
| 450110* | 12V 23/8W | feu/stop transparent          | TUNER   |
| 480270  | 12V 21/5W | 7 LEDs tournantes multi-color | TUNER   |
| 494325  | 12V 21/5W | 18 LEDs blanc feu/stop        | TUNER   |



## LAMPE/AMPOULE TÉMOIN TABLEAU DE BORD T5

|        |        |
|--------|--------|
| 377292 | bleu   |
| 377326 | orange |
| 377307 | rouge  |
| 377311 | vert   |



## LAMPE/AMPOULE TÉMOIN TABLEAU DE BORD

|        |        |                                   |       |
|--------|--------|-----------------------------------|-------|
| 491060 | 6V 5W  | feu de position navette C5W SV8.5 | 11x35 |
| 491062 | 6V 10W | navette C10W SV8.5                | 11x40 |
| 491061 | 12V 5W | feu de position navette C5W SV8.5 | 11x35 |



## CONTACTEUR TÉMOIN

|        |                                      |
|--------|--------------------------------------|
| 460628 | type origine position point mort AM6 |
|--------|--------------------------------------|



## CONTACTEUR INTERRUPTEUR

|        |                          |
|--------|--------------------------|
| 479824 | à levier petit modèle    |
| 478381 | on/off standard à levier |
| 6706   | phare 103 SP             |

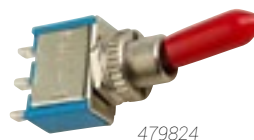

\*Produits destinés à des concours tuning, usage interdit sur la voie publique.



### CONTACTEUR INTERRUPTEUR

479499 on/off encastrable



### CONTACTEUR DE STOP

319894 F10/F15 Ø8.5mm

479116 gris avec vis

487834 arrière hydraulique M10x1.00mm

487248 pour maître cylindre universel

252609 universel adaptable Ø6mm



319894



479116



487834



487248



252609



### LOUPE/LENTILLE POUR LAMPE DICHROÏQUE

451090 bleu

451089 transparent



451090



451089



### PATTE SUPPORT PHARE

2744 chrome

321580 chrome

489445 noir



2744

321580



489445



### PORTE AMPOULE

472620 BOOSTER | BW'S 2004->

467861 BOOSTER | BW'S | AEROX | NITRO | STUNT | SLIDER ->2004

475167 STUNT | SLIDER 2004->



472620



467861



475167



### RÉSISTANCE DE CLIGNOTANT AVEC CONNECTIQUE

468228 12 Ohms pour 10W x2

480682 10 Ohms pour 21W x2



468228

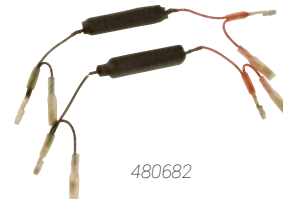

480682



## LAMPE PROJECTEUR 6V

EP10

**2701** 6V 6W projecteur avant cyclo, à visser 

P26S

**461977** 6V 15W 

**2691** 6V 15W 



## LAMPE PROJECTEUR 12V

P26S

**461976** 12V 15W 

**2695** 12V 15W 

**2699** 12V 15W halogène collerette 

**476188** 12V 20W type Xenon Super Blue SB2 5 

BA20D

**479415** 12V 25/25W 

**487515** 12V 35/35W OSRAM PRO JECTEUR -HALOGENE- (BA20D S2) halogène type S2 

**478465** 12V 35/35W 

**208869** 12V 35/35W 

**175179** 12V 35/35W 

**384984** 12V 45/40W 

**495302** 12V 35/35W halogène 

**495303** 12V 35/35W halogène bleu 

**491050** 12V 45/40W 

**472798** 12V 35/35W type Xenon 

**473477** 12V 35/35W type Xenon super bleu 

PX43T

**490221** 12V 35/35W HS1 

**363012** 12V 35/35W HS1 

**476181** 12V 35/35W HS1 



## LAMPE PROJECTEUR 12V

## PGJ19-1

|               |         |    |              |
|---------------|---------|----|--------------|
| <b>487242</b> | 12V 35W | H8 | <b>OSRAM</b> |
|---------------|---------|----|--------------|

|               |         |    |   |
|---------------|---------|----|---|
| <b>491052</b> | 12V 35W | H8 |  |
|---------------|---------|----|---|

## BA21d

|               |            |  |   |
|---------------|------------|--|---|
| <b>495531</b> | 12V 36/45W |  |  |
|---------------|------------|--|---|

## P43T

|               |            |    |   |
|---------------|------------|----|---|
| <b>490220</b> | 12V 60/55W | H4 |  |
|---------------|------------|----|---|

|               |            |    |              |
|---------------|------------|----|--------------|
| <b>283569</b> | 12V 60/55W | H4 | <b>OSRAM</b> |
|---------------|------------|----|--------------|

|               |            |               |              |
|---------------|------------|---------------|--------------|
| <b>472467</b> | 12V 60/55W | H4 type Xenon | <b>OSRAM</b> |
|---------------|------------|---------------|--------------|

|               |            |                 |   |
|---------------|------------|-----------------|---|
| <b>384821</b> | 12V 60/55W | H4 blister de 2 |  |
|---------------|------------|-----------------|---|

## PK22S

|               |         |    |   |
|---------------|---------|----|---|
| <b>490222</b> | 12V 55W | H3 |  |
|---------------|---------|----|---|

|               |         |                        |  |
|---------------|---------|------------------------|--|
| <b>384855</b> | 12V 55W | H3 phare longue portée |  |
|---------------|---------|------------------------|--|

|               |         |    |              |
|---------------|---------|----|--------------|
| <b>490707</b> | 12V 55W | H3 | <b>OSRAM</b> |
|---------------|---------|----|--------------|

## PX26D

|               |         |    |              |
|---------------|---------|----|--------------|
| <b>211804</b> | 12V 55W | H7 | <b>OSRAM</b> |
|---------------|---------|----|--------------|

|               |         |               |              |
|---------------|---------|---------------|--------------|
| <b>472468</b> | 12V 55W | H7 type Xenon | <b>OSRAM</b> |
|---------------|---------|---------------|--------------|

|               |         |    |   |
|---------------|---------|----|---|
| <b>384783</b> | 12V 55W | H7 |  |
|---------------|---------|----|---|

|               |         |                     |   |
|---------------|---------|---------------------|---|
| <b>494328</b> | 12V 55W | H7 blanc 480 Lumens |  |
|---------------|---------|---------------------|---|

|               |         |    |   |
|---------------|---------|----|---|
| <b>491051</b> | 12V 55W | H7 |  |
|---------------|---------|----|---|

## PGJ19-2

|               |         |     |              |
|---------------|---------|-----|--------------|
| <b>490706</b> | 12V 55W | H11 | <b>OSRAM</b> |
|---------------|---------|-----|--------------|

## P20D

|               |         |     |              |
|---------------|---------|-----|--------------|
| <b>490705</b> | 12V 60W | HB3 | <b>OSRAM</b> |
|---------------|---------|-----|--------------|

## PGJ19-5

|               |         |    |              |
|---------------|---------|----|--------------|
| <b>490704</b> | 12V 65W | H9 | <b>OSRAM</b> |
|---------------|---------|----|--------------|



487242



491052



495531



490220



283569



472467



384821



490222



384855



490707



211804



472468



384783



494328



491051



490706



490705



490704



## DOUILLE CÉRAMIQUE

451088 pour lampe dichroïque



## LAMPE DICHROÏQUE

|        |         |       |                   |       |
|--------|---------|-------|-------------------|-------|
| 455206 | 12V 20W | Ø35mm | halogène          | blanc |
| 333677 | 12V 20W | Ø50mm | halogène          | blanc |
| 452038 | 12V 20W | Ø50mm | halogène          | bleu  |
| 452041 | 12V 20W | Ø50mm | halogène          | jaune |
| 452040 | 12V 20W | Ø50mm | halogène          | rouge |
| 452039 | 12V 20W | Ø50mm | halogène          | vert  |
| 494362 | 12V 35W | Ø35mm | 6 LEDs 120 Lumens | blanc |
| 494327 | 12V 35W | Ø50mm | 6 LEDs 120 Lumens | blanc |



455206



333677



452038



452041



452040



452039



494327



## LAMPE DICHROÏQUE

|        |         |                                 |       |
|--------|---------|---------------------------------|-------|
| 476179 | 12V 20W | MR16/G030 Ø50mm                 | blanc |
| 476180 | 12V 35W | MR16/G030                       | blanc |
| 473481 | 12V 35W | MR16/G030 type Xenon super bleu | bleu  |



476179



476180



473481



### INFO TECHNIQUE

Ce logo vous indique qu'une notice de montage du produit est disponible sur le **WinCGN**.

NOTICE



**KOSO**

476317

### COMPTEUR DIGITAL DB02-R RACING MULTIFONCTION AVEC SUPPORT UNIVERSEL

- ↳ compteur de vitesse
- ↳ totaliseur kilométrique
- ↳ totaliseur de fonctionnement
- ↳ totaliseur d'heures
- ↳ compteur-tours
- ↳ jauge essence
- ↳ sonde température x2
- ↳ horloge
- ↳ indicateur de dépassement de vitesse
- ↳ indicateur de plage (tour/min)
- ↳ alerte voyant température réglable de 60°C à 250°C
- ↳ rétro-éclairage blanc
- ↳ mode départ/arrêt en fonction du temps, de la vitesse maximum et de la distance
- ↳ compatible 2 temps et 4 temps

NOTICE



**KOSO**

477146

### COMPTEUR DIGITAL XR-SRN MULTIFONCTIONS

- ↳ compteur de vitesse
- ↳ totaliseur kilométrique total et partiel
- ↳ compte-tours
- ↳ jauge essence
- ↳ sonde température
- ↳ témoin huile
- ↳ horloge
- ↳ affichage: clignotant, warning, point mort, feu de route, feu de croisement
- ↳ compatible 2 temps et 4 temps

NOTICE



**KOSO**

477207

### COMPTEUR DIGITAL DB01-RN MULTIFONCTIONS MRT PRO

- ↳ compteur de vitesse
- ↳ totaliseur kilométrique total et partiel
- ↳ compte-tours
- ↳ jauge essence
- ↳ jauge température
- ↳ sonde température
- ↳ témoin huile
- ↳ indication charge batterie
- ↳ affichage: clignotant, feu de route, neutre
- ↳ voyant point mort
- ↳ compatible 2 temps et 4 temps

NOTICE



**KOSO**

477766

### COMPTEUR DIGITAL STREET STYLE MBK/YAMAHA ENTRAINEUR MÉCANIQUE À VISSER

- ↳ compteur de vitesse
- ↳ totaliseur kilométrique
- ↳ jauge essence
- ↳ compatible 2 temps et 4 temps

NOTICE



**KOSO**

494437

## COMPTEUR DIGITAL MULTIFONCTIONS DB EX-02

NOTICE

- ↳ compteur heure
- ↳ compteur de vitesse
- ↳ fonction Voltmètre
- ↳ horloge
- ↳ rétroéclairage blanc
- ↳ voyants: feux de route, clignotants, voyant moteur, warning
- ↳ compatible 2 temps et 4 temps

**KOSO**

## PIÈCES DÉTACHÉES

- 482878** capteur pour compteur DB02-R Racing et BD01-R longueur 155cm
- 478194** adaptateur pour commande de compteur origine BOOSTER ->2003 | NITRO | AEROX ->2013
- 481517** adaptateur pour démultiplicateur d'origine PEUGEOT | MBK à visser
- 481933** aimant de compteur petit modèle (x1)



482878



478194



481517



481933



461609



466289

**TUN'R**

461609

## COMPTEUR DIGITAL MULTIFONCTION (AVEC SUPPORT UNIVERSEL)

- 466289** Capteur pour compteur digital multifonctions

NOTICE

- ↳ compteur de vitesse
- ↳ totaliseur kilométrique total et partiel
- ↳ téloin d'huile
- ↳ jauge essence
- ↳ affichage: clignotant, feu de route,
- ↳ compatible 2 temps et 4 temps



**TUN'R**

492395

## COMPTEUR DIGITAL MULTIFONCTION ÉDITION 2016 (AVEC SUPPORT UNIVERSEL)

- ↳ compteur de vitesse
- ↳ totaliseur d'heure
- ↳ décompte kilométrique périodicité entretien véhicule
- ↳ indication charge batterie
- ↳ indication jauge d'essence 6 niveau
- ↳ horloge 24h
- ↳ passage de MH:h a KM/h par une pression de 3 secondes sur le bouton adjust de l'écran principal
- ↳ possibilité d'utiliser le voyant warnng pour le témoin d'huile
- ↳ réglage du retroéclairage à 5 niveaux
- ↳ tripp A et B
- ↳ affichage: clignotant droit et gauche, plein phare, point mort

**TUN'R**
**VERRE COMPTEUR BLEU (UNIQUEMENT SCOOTER)**

335487

BOOSTER SPIRIT | BWS -&gt;2003



451884

**COMPTEUR DIGITAL MC700**

- ↳ compteur de vitesse instantannée, maximale et moyenne
- ↳ indicateur de vitesse numérique jusqu'à 199km/h
- ↳ totaliseur kilométrique total et partiel
- ↳ totaliseur de fonctionnement total et partiel
- ↳ grand affichage numérique
- ↳ horloge digitale
- ↳ départ/arrêt automatique
- ↳ protection antivol
- ↳ boîtier étanche
- ↳ type de pile C2032



486960

**COMPTEUR DIGITAL MC10**

- ↳ compteur de vitesse instantannée, moyenne et maximale
- ↳ totaliseur de kilomètre partiel et total
- ↳ totaliseur d'heure journalier et total
- ↳ horloge
- ↳ départ/arrêt automatique
- ↳ 3 langues différentes au choix
- ↳ type de pile 2032

**NOTICE**

485485

**COMPTEUR DIGITAL MC18.12**

- ↳ compteur de vitesse instantannée, maximale, moyenne
- ↳ totaliseur kilométrique total et partiel
- ↳ totaliseur d'heure quotidien et total
- ↳ mesure de l'accélération
- ↳ mesure de la reprise
- ↳ mesure du coefficient de freinage
- ↳ course d'accélération
- ↳ horloge
- ↳ type de pile CR2450

## COMPTEUR / SPEEDOMETER

**KOSO**

476857

**COMPTE-TOURS SPORT ROND NOIR**

- ↳ 0 -18 000 tours/min
- ↳ jauge essence
- ↳ affichage de la température
- ↳ rétro éclairage bleu
- ↳ Ø extérieur 60mm
- ↳ livré avec tout le nécessaire de branchement et kit de fixation
- ↳ compatible 2 temps et 4 temps

**KOSO**

477145

**COMPTE-TOURS AIGUILLE**

- ↳ 0-16 000 tours/min
- ↳ jauge essence
- ↳ affichage de la température
- ↳ rétro éclairage bleu
- ↳ Ø extérieur 60mm
- ↳ livré avec tout le nécessaire de branchement et kit de fixation
- ↳ compatible 2 temps et 4 temps



484961

**COMPTE-TOURS DIGITAL LCD**

- ↳ 22 000 tours/min
- ↳ sans sonde lambda
- ↳ livré avec une pile, un velcro double face
- ↳ temps de roulage instantané et total
- ↳ compatible 2 temps et 4 temps



492994

**COMPTE-TOURS DIGITAL LCD**

- ↳ 15 000 tours/min
- ↳ sans sonde lambda
- ↳ rétro éclairage blanc



487571

**MONTRE**

- ↳ aluminium CNC argent
- ↳ fixation sur guidon



482498

**SONDE TEMPÉRATURE EXTERNE DIGITALE**

- ↳ 93°C maximum
- ↳ se clipse sur les côtés



Sélection  
**CGN**

490377

### CAMÉRA EMBARQUÉE SPORT HD

- ↳ Fournie avec télécommande, caisson étanche, fixations casque et fixations guidon
- ↳ Écran LCD 2.4"
- ↳ Capteur d'image 5.0 pixelscmOS sensor
- ↳ Résolution d'image jusqu'à 12 mega pixels (4000x3000)
- ↳ Résolution vidéo jusqu'à 1080p (1920x1080)
- ↳ Micro intégré
- ↳ Mémoire interne DDRIII 1Go, 8mo SPI
- ↳ Mémoire externe : carte micro SD jusqu'à 32Go
- ↳ Zoom digital x4
- ↳ Contrôle électronique d'obturateur
- ↳ Fonction détection visage
- ↳ Prise USB 2.0 et port HDMI
- ↳ Batterie Lithium 1500 m/Ah
- ↳ Poids de 72g avec batterie



### CHARGEUR ALLUME CIGARE FIXATION GUIDON

488703 prise 12V/USB 5V-2.1A



485725 prise 12V



488703



485725





## TRANSVAL

### COMPTEUR 120 KM/H

|               |                    |             |
|---------------|--------------------|-------------|
| <b>2648</b>   | 103 SP   SPX   RCX | roue de 17" |
| <b>220137</b> | 103 SP   SPX   RCX | roue de 16" |
| <b>2652</b>   | 103 MVL            | roue de 17" |
| <b>367496</b> | 103 MVL   VOGUE    | roue de 16" |
| <b>2656</b>   | MBK 51S            | Grimeca     |
| <b>2655</b>   | MBK 51S            | Leleu       |
| <b>334772</b> | MBK CLUB           |             |
| <b>2653</b>   | MBK 88             |             |



2648



220137



2652



367496



2656



2655



334772



2653



## DÉMULTIPLICATEUR DE COMPTEUR DIGITAL



**479931**

NITRO | AEROX 2013-> | OVETTO | NEOS 2008->  
naked digital



**479932**

VIVACITY 1 et 2  
digital



TEKNIX

## DÉMULTIPLICATEUR DE COMPTEUR



479924

TYPHOON ancien modèle



479928

BUXY | SPEEDAKE



479927

NRG | RUNNER



479933

KEEWAY | CPI



479929

VIVACITY | TREKKER | LUDIX |  
JET FORCE

479934

SYM MIO



479935

ZIP 2009-&gt;



491117

SCOOTER CHINOIS



372286

BOOSTER 1995-> | NITRO  
->2013 | STUNT ->2009

479926

OVETTO | NEOS ->1999 fixation  
vissée ancien modèle

479930

OVETTO | NEO'S 1999->2004  
fixation vissée nouveau modèle

462115

LUDIX TRENT 10 POUCES |  
ELEGANCE

TEKNIX

## DÉMULTIPLICATEUR DE COMPTEUR



482187

DERBI SENDA axe de 12mm



482188

DERBI SENDA DRD axe de 15mm



491119

RIEJU RR



TEKNIX

## DÉMULTIPLICATEUR DE COMPTEUR



486308

103 | VOGUE | SPX | RCX roue 16"



2646

MBK 51 roue 17"



483985

MBK 88 roue 18"





## TRANSMISSION DE COMPTEUR

|  |  |  |  |
|--|--|--|--|
| <br> <p><b>212777</b></p> <p>BOOSTER NG   ROCKET   NEXT   STUNT 930mm hors tout</p>                | <br> <p><b>177774</b></p> <p>BOOSTER ORIGINAL frein tambour 900mm hors tout</p>                        | <br> <p><b>487665</b></p> <p>BOOSTER ONE   BW'S EASY 940mm hors tout</p>                             | <br> <p><b>188649</b></p> <p>BOOSTER   BW'S -&gt;2003 frein à disque</p>               |
| <br> <p><b>458204</b></p> <p>BOOSTER SPIRIT   BW'S 2004-&gt;</p>                                   | <br> <p><b>252651</b></p> <p>NITRO   AEROX -&gt;2004   OVETTO   NEOS 1999-&gt;2004 980mm hors tout</p> | <br> <p><b>480216</b></p> <p>NITRO   AEROX 2004-&gt;2013   KATANA   CPI 2 écrous 990mm hors tout</p> | <br> <p><b>252647</b></p> <p>OVETTO   NEOS -&gt;1999 ancien modèle 965mm hors tout</p> |
| <br> <p><b>460067</b></p> <p>LUDIX 10/12/14 frein à disque 960mm hors tout</p>                  | <br> <p><b>460070</b></p> <p>LUDIX 10/14 frein à tambour 845mm hors tout</p>                       | <br> <p><b>231631</b></p> <p>SPEEDFIGHT 1 et 2   1100mm hors tout</p>                            | <br> <p><b>191508</b></p> <p>BUXY   ZENIT   SPEEDAKE 1060mm hors tout</p>          |
| <br> <p><b>269558</b></p> <p>TREKKER   SQUAB   TKR 1000mm hors tout</p>                        | <br> <p><b>487253</b></p> <p>KISBEE 2 et 4 temps 1015mm hors tout</p>                              | <br> <p><b>177789</b></p> <p>TYPHOON -&gt;1997   NRG -&gt;1997   NTT 945mm hors tout</p>         | <br> <p><b>481729</b></p> <p>PIAGGIO ZIP 50 2 et 4 temps 950mm hors tout</p>       |
| <br> <p><b>243631</b></p> <p>PIAGGIO ZIP 1992-&gt;1998 frein avant tambour 920mm hors tout</p> | <br> <p><b>486238</b></p> <p>LIBERTY 50 2 et 4 temps 950mm hors tout</p>                           | <br> <p><b>252613</b></p> <p>NRG -&gt;1996   NTT   TYPHOON -&gt;1996 950mm hors tout</p>          | <br> <p><b>252632</b></p> <p>STALKER 985mm hors tout</p>                           |



TRANSMISSION DE COMPTEUR



479806

VESPA ET2/ET4  
1110mm hors tout



478786

KEEWAY F-ACT | FOCUS |  
MATRIX | ADRESS SUZUKI  
1100mm hors tout



482393

KYMCO AGILITY 50/125  
990mm hors tout



210243

F12 1045mm hors tout



482330

SCOOTER CHINOIS 925mm hors tout



482329

SCOOTER CHINOIS 980mm hors tout



TRANSMISSION DE COMPTEUR



269577

RS50 1993->1998  
775mm hors tout



252613

SENDA 2000->2001  
952mm hors tout



269562

SENDA ->1999 vissé 2 côtés  
1110mm hors tout



378227

SENDA 2000-> clipsé en haut  
vissé en bas 926mm hors tout



287951

GPR 50 1997->2003 | GP50  
800mm hors tout



287990

SUZUKI RMX 50 ->1999 | DR50  
890mm hors tout



450107

X-POWER | TZR ->2003  
978mm hors tout



335912

X-LIMIT | DT50 R  
898mm hors tout



335927

XP6 880mm hors tout



287985

RIEJU RR50 | SPIKE  
930mm hors tout



287977

RIEJU RS1 | RS2 MATRIX  
910mm hors tout



490672

BETA RR 1999->2002  
672mm hors tout



## TRANSMISSION DE COMPTEUR



**437951**

103 FOX | FXR  
longueur 760mm carré  
2.5x2.5mm



**437947**

FOX PRO | 103 SPX | 103 RCX  
gros carré  
longueur 760mm carré  
2.5x2.5mm



**711**

103 MVL VEGLIA  
longueur 585mm carré  
1.75x1.75mm



**195063**

103 FACOMSA  
longueur 755mm carré  
1.8x1.8mm



**482031**

103 SP HURET | TRANSVA  
longueur 750mm carré  
2.6x2.6mm



**13833**

103 SP VEGLIA  
longueur 725mm carré  
1.8x1.8mm



**231627**

51 EVASION HURET  
longueur 660mm carré  
1.7x1.7mm



**482030**

51 | 88 | MVL HURET |  
TRANSVAL  
longueur 620mm carré 3x3mm



**2641**

MBK 51S petit carré  
longueur 645mm carré 1.8x1.8mm



**3406**

CIAO PX  
longueur 835mm carré 2.6x2.6mm



### EMBOUT DE CÂBLE COMPTEUR

**481603**

embout plastique de transformation câble petit carré en HURET/TRANSVAL





# GUIDON / HANDLER BAR

## GUIDON CROSS ALU

- 465896 argent brillant
- 440067 argent mat
- 461185 blanc
- 440068 bleu
- 440572 carbone
- 440573 noir
- 440072 or
- 482327 orange
- 440069 rouge
- 482328 vert

- L: 630mm
- D: 22.2mm
- e: 8°
- h: 75mm
- f: 8°

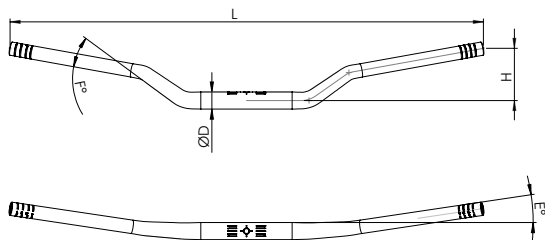

## GUIDON CROSS ALU AVEC POTENCE

- 440582 BOOSTER noir
- 440583 BOOSTER argent
- 440576 BOOSTER bleu



440582



440583



440576



## DOPPLER

### POTENCE Ø22MM

#### APRILIA SONIC

**473305** argent

#### BOOSTER | BW'S

**451829** argent

**473487** blanc

**451830** bleu

**451831** rouge

**451832** titane

#### LUDIX | JET FORCE

**460664** argent

**473488** blanc

**460665** bleu

**460667** titane

#### NITRO | AEROX

**460786** alu poli

**458181** argent

**458182** bleu

**458183** rouge

**458184** titane

#### NRG

**451837** argent

**451838** bleu

**451839** rouge

**451840** titane

#### SPEEDFIGHT

**451833** argent

**451834** bleu

**451835** rouge

**451836** titane



473305



451829



451831



451830



473487



451829



460667



460665



473488



460664



458184



458183



458182



458181



460786



451840



451839



451838



451837



451836



451835



451834



451833



TUN'R

GUIDON / HANDLER BAR

POTENCE DROITE ALU POUR GUIDON CROSS Ø22MM

BOOSTER | BW'S

- 441252 noir
- 383643 argent
- 460045 blanc
- 441251 carbone
- 383662 rouge

NITRO

- 460056 argent

TYPHOON | NRG

- 440903 argent



441252



383643



460045



441251



383662



460056



440903

DOPPLER

MOUSSE DE GUIDON

- 487274 bleu
- 487275 jaune
- 472495 noir | gris
- 487276 rouge
- 487277 vert



487274



487275



472495



487276



487277

TUN'R

MOUSSE DE GUIDON

- |        |                    |              |
|--------|--------------------|--------------|
| 465284 | damier             | bleu         |
| 465280 | tête de mort bleu  | bleu   rouge |
| 465282 | tête de mort rouge | rouge   noir |



465284



465280



465282



# GUIDON / HANDLER BAR

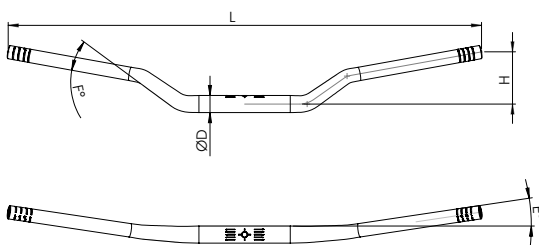

## GUIDON CROSS ALU

|        |                  |
|--------|------------------|
| 335855 | argent           |
| 462589 | blanc            |
| 335860 | bleu             |
| 440097 | carbone brillant |
| 497420 | jaune fluo       |
| 335889 | noir             |
| 335893 | or               |
| 487857 | orange           |
| 497423 | orange fluo      |
| 335874 | rouge            |
| 497421 | rouge fluo       |
| 487856 | vert             |
| 497422 | vert fluo        |

- ↪ L: 810mm
- ↪ D: 22.2mm
- ↪ e: 7°
- ↪ h: 90mm
- ↪ f: 15°



## GUIDON CROSS RACING ALU

|        |        |
|--------|--------|
| 487268 | argent |
| 487269 | blanc  |
| 487266 | noir   |
| 487267 | titane |

- ↪ L: 740mm
- ↪ D: 22.2mm
- ↪ e: 9°
- ↪ h: 120mm
- ↪ f: 15°



## GUIDON CROSS ALU OVERSIZE

|        |        |
|--------|--------|
| 480425 | argent |
| 480424 | blanc  |
| 480422 | bleu   |
| 480426 | noir   |
| 480427 | or     |
| 480423 | rouge  |

- ↪ L: 810mm
- ↪ D: 28mm
- ↪ e: 4°
- ↪ h: 80mm
- ↪ f: 12°



**DOPPLER**
**MOUSSE DE GUIDON**

|        |       |
|--------|-------|
| 486811 | bleu  |
| 486809 | jaune |
| 486810 | rouge |
| 486812 | vert  |

**TUN'R**
**PONTET ALU POUR GUIDON CROSS/ENDURO**

|        |                        |        |    |
|--------|------------------------|--------|----|
| 482621 | argent                 | 22.0mm | x2 |
| 482622 | carbone                | 22.0mm | x2 |
| 482125 | avec rehausse amovible | 22.2mm | x2 |
| 482126 | avec rehausse amovible | 28.6mm | x2 |
| 464988 | avec rehausse amovible | 28.6mm | x1 |
| 493145 | avec rehausse amovible | 28.6mm | x2 |

**Polisport**
**PROTÈGE-MAIN SHARP SANS FIXATION (PAIRE)**

|        |            |
|--------|------------|
| 460863 | noir       |
| 460864 | blanc      |
| 460865 | bleu yam   |
| 460867 | orange KTM |
| 460869 | rouge      |
| 460866 | vert       |

**Polisport**
**PROTÈGE-MAIN ÉVOLUTION-INTÉGRAL (PAIRE)**

|        |          |
|--------|----------|
| 490438 | noir     |
| 490437 | blanc    |
| 490439 | bleu yam |
| 490440 | jaune    |
| 490441 | orange   |
| 490443 | rouge    |
| 490442 | vert     |





Polysport

## KIT DE FIXATION POUR PROTÈGE-MAIN

- 464941 Free Flow
- 461844 Sharp 12mm



464941

461844



## PROTÈGE-MAIN ESCALADE (PAIRE)

- 491220 blanc | bleu
- 491218 blanc | noir
- 491221 blanc | rouge
- 491246 noir | blanc
- 491223 noir | jaune
- 491222 noir | orange
- 491219 noir | vert



491220

491218

491221

491246

491223

491222

491219



## PROTÈGE-MAIN PATROL (PAIRE)

- 491242 blanc | noir
- 491237 bleu | blanc
- 491236 jaune | noir
- 491240 noir | blanc
- 491238 orange | noir
- 491241 rouge | blanc
- 491239 vert | noir



491242

491237

491236

491240

491238

491241

491239



## PROTÈGE-MAIN FREESTYLE (PAIRE)

- 473345 fixation par collier noir
- 473344 fixation par collier blanc



473345



473344

**TUN'R**
**PROTÈGE-MAIN INTÉGRAL 1 (PAIRE)**

|               |                     |         |
|---------------|---------------------|---------|
| <b>335635</b> | fixation 14 et 18mm | noir    |
| <b>362991</b> | fixation 14 et 18mm | carbone |
| <b>335627</b> | fixation 14 et 18mm | blanc   |
| <b>335640</b> | fixation 14 et 18mm | bleu    |
| <b>335654</b> | fixation 14 et 18mm | rouge   |

**TUN'R**
**PROTÈGE-MAIN INTÉGRAL MOTO CROSS (PAIRE)**

|               |               |                     |       |
|---------------|---------------|---------------------|-------|
| <b>462582</b> | grande taille | fixation 18mm       | noir  |
| <b>462579</b> | grande taille | fixation 18mm       | blanc |
| <b>462580</b> | grande taille | fixation 18mm       | bleu  |
| <b>462588</b> | petite taille | fixation 14 et 18mm | noir  |

**TUN'R**
**PROTÈGE-MAIN WINGS\* (PAIRE)**
**489439** noir à leds

\*Produit destiné à des concours tuning, usage interdit sur la voie publique

**TUN'R**
**PROTÈGE-MAIN ALU (PAIRE)**

|               |        |
|---------------|--------|
| <b>491339</b> | argent |
| <b>491340</b> | rouge  |





Sélection  
**CGN**

## GUIDON CHROME

|               |                               |                         |    |
|---------------|-------------------------------|-------------------------|----|
| <b>2815</b>   | bracelet                      | Ø26-28mm                | x2 |
| <b>168018</b> | bracelet                      | Ø28-30mm                | x2 |
| <b>168022</b> | bracelet                      | Ø32-35mm                | x2 |
| <b>2806</b>   | z.barre torsadé               | hauteur 5cm             | x1 |
| <b>2803</b>   | z.barre torsadé               | hauteur 20cm            | x1 |
| <b>2810</b>   | z.barre lisse                 | hauteur 5cm             | x1 |
| <b>2809</b>   | z.barre lisse                 | hauteur 10cm            | x1 |
| <b>2814</b>   | 103 MVL   VOGUE   CHRONO      | longueur 14cm coudé 90° | x2 |
| <b>2813</b>   | 103 MVL   VOGUE équerre lisse | longueur 30cm coudé 90° | x2 |
| <b>496080</b> | 103 SP   SPX                  |                         | x1 |
| <b>496081</b> | MBK 88   41   89              |                         | x1 |
| <b>496082</b> | MBK 51                        |                         | x1 |



2815



168018



168022



2806



2803



2810



2809



2814



2813



496080



496081



496082

**TUN'R**
**EMBOUT DE GUIDON CÔNE (PAIRE)**

|               |       | Ø intérieur | Couleur |
|---------------|-------|-------------|---------|
| <b>451788</b> | alu   | 14mm        | carbone |
| <b>451789</b> | alu   | 14mm        | chrome  |
| <b>451792</b> | acier | 14mm        | rouge   |



451788



451789



451792

**TUN'R**
**EMBOUT DE GUIDON (PAIRE)**

|               |              | Ø intérieur | Couleur        |
|---------------|--------------|-------------|----------------|
| <b>276795</b> | moleté acier | 17mm        | bleu           |
| <b>186851</b> | moleté acier | 17mm        | chrome         |
| <b>386467</b> | plat         | 14mm        | noir           |
| <b>452042</b> | rond acier   | 17mm        | carbone   bleu |



276795



186851



386467



452042

# CONTACTEUR-ALARME / SWITCH-ALARM



## TEKNIX CONTACTEUR À CLÉ



**452047**

BOOSTER SPIRIT | BW'S ->2003 | STUNT | SLIDER 3 fils

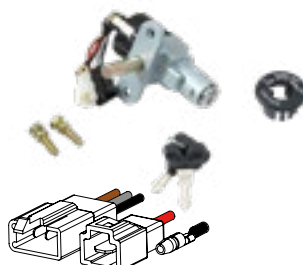

**254252**

BOOSTER | BW'S ->2003 | STUNT | SLIDER 5 fils sans serrure de selle

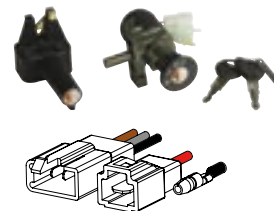

**1811**

BOOSTER-ROAD->2003 | STUNT | SLIDER avec serrure de selle



**458207**

BOOSTER | BW'S 2004-> 3 fils

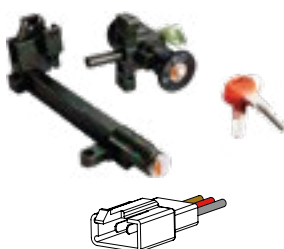

**458208**

BOOSTER ROCKET | NG 2003-> 3 fils + serrure de selle

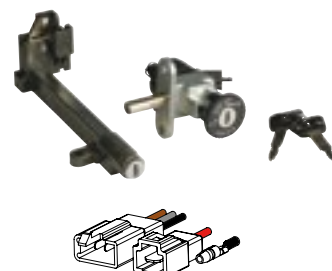

**254271**

BOOSTER ROCKET|NG ->2002 5 fils + serrure de selle



**318132**

NITRO | AEROX ->2002 bouchon réservoir, trappe batterie



**458470**

NITRO | AEROX 2003->2013 3 fils bouchon réservoir, trappe batterie

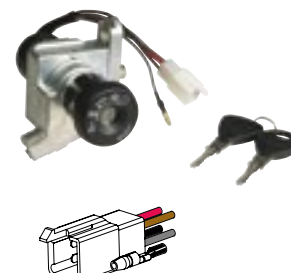

**318128**

OVETTO | NEOS ->2002

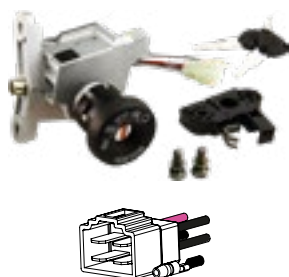

**458471**

OVETTO | NEOS 2003 à 2008 5 fils

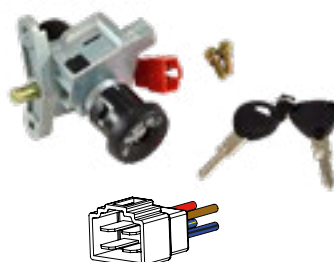

**487746**

OVETTO | NEOS 2008-> 4 temps | NITRO 2 et 4 temps 2013-> 4 fils



**207623**

BUXY | SPEEDAKE | ZENIT

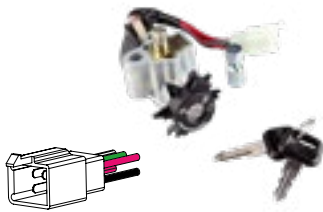
**TEKNIX CONTACTEUR À CLÉ**

**466092**

LUDIX selle monoplace | TREKKER

**479195**

LUDIX TREND | SNAKE | BLASTER avec serrure de selle

**270277**

SPEEDFIGHT 1 | SQUAB | TREKKER

**440261**

VIVACITY | SPEEDFIGHT 2 | TKR

**487828**

SPEEDFIGHT 3, 4 fils+bouchon réservoir+verrou coffre

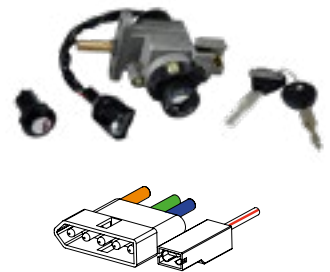
**491365**

VIVACITY 2008-&gt; 2 et 4 temps

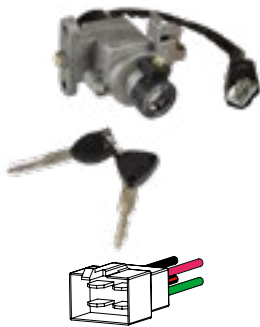
**487829**

PEUGEOT KISBEE

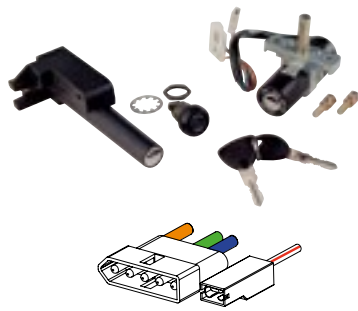
**254267**

SR50 MOTEUR MINARELLI

**252518**

TYPHOON | STALKER | NRG jeu de barillet petit diamètre Ø12.84mm

**468253**

RUNNER | VESPA | LIBERTY | TYPHOON 2011-&gt; | NRG 2010-&gt; Ø12.80mm

**480416**

ZIP 50 COMPLET 2000-&gt; | FLY | VESPA avec barillets

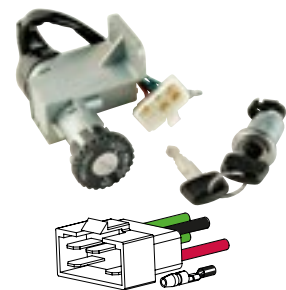
**480663**

KYMCO AGILITY avec serrure de selle



# CONTACTEUR-ALARME / SWITCH-ALARM



## TEKNIX CONTACTEUR À CLÉ

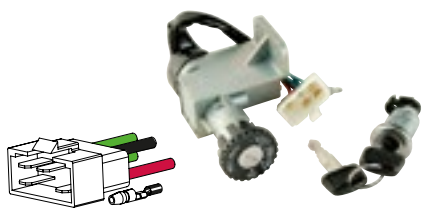

**479214**

KYMCO VITALITY avec serrure de selle

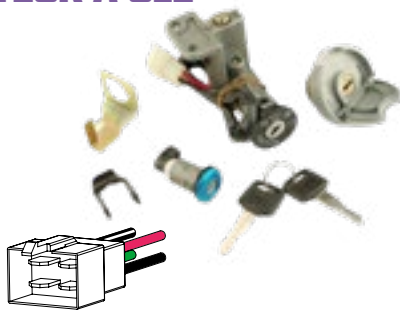

**489851**

KYMCO VITALITY serrure de selle+bouchon de réservoir



**467413**

CPI POP CORN | HUSSARD

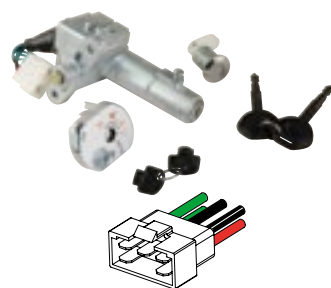

**484755**

SYM MIO



**479207**

KEEWAY FOCUS | F-ACT 2007-> serrure de selle+bouchon de réservoir

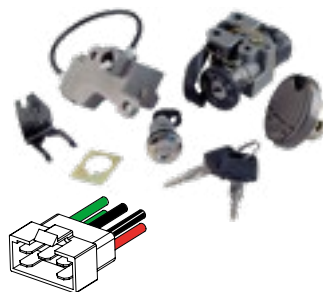

**468840**

SCOOTER CHINOIS | VLCLC 10" et 12" selon modèle

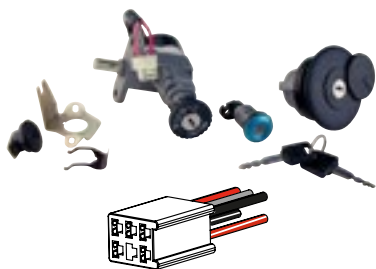

**479322**

SCOOTER CHINOIS 10" et 12" selon modèle



**468252**

TYPHOON 2 barillets + 2 clés petit diamètre Ø12.78mm



## TEKNIX CONTACTEUR À CLÉ

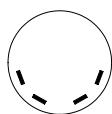

**450113**

XP6 | UNIVERSEL 4 broches



**451423**

XR6

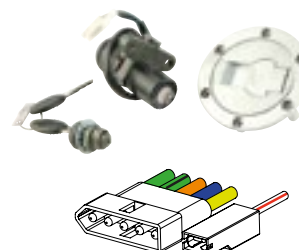

**479196**

DERBI GPR 50 NUDE | RACING 2004->2010 | RS50 2006->2010



TEKNIX

## CONTACTEUR À CLÉ

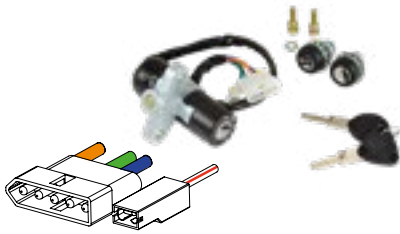
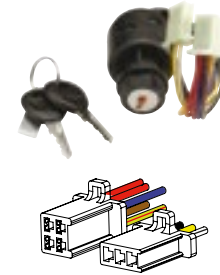
**336058**DERBI SENDA|APRILIA RX  
avec serrure de selle**491364**DERBI SENDA|GPR APRILIA  
RX50|RS50|GILERA SMT|RCR**450114**

X-LIMIT|DT50

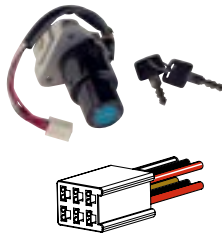
**451422**

X POWER|TZR 1997 -&gt; 2002 seul

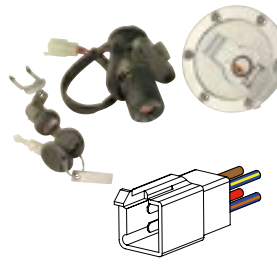
**478324**X POWER|TZR 2003-> avec serrure de selle  
et réservoir**451424**

RS50 APRILIA -&gt;1999

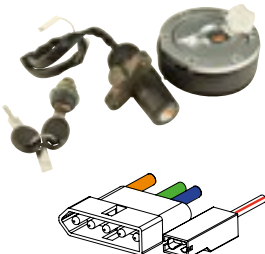
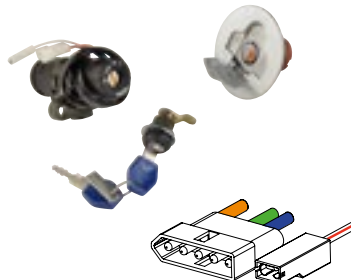
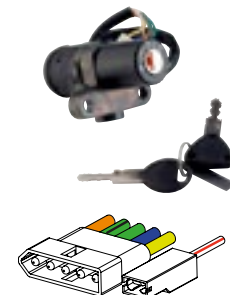
**479267**RS50 2006->2010 | GPR 2006->2011 +bou-  
chon essence et serrure 3+1 fils**484779**RS2 MATRIX|NAKED|NK7|XR7 avec serrure  
de selle et réservoir**475161**RIEJU MR|MRX|SMX|RS2|XR6|XR7|NK7|XP7|  
XP6|XPS|TANGO**485984**

CPI SUPER MOTARD COMPLET



Sélection  
**CGN**

## ACCESSOIRE

|               |                    |   |
|---------------|--------------------|---|
| <b>487831</b> | écrou auto cassant | pour contacteur à clé type PEUGEOT LUDIX TREKKER SPEEDFIGHT VIVACITY (X2) |
| <b>487830</b> | vis auto cassante  | pour contacteur à clé NIEMAN type YAMAHA MBK (X2)                         |



## CAPUCHON DE CONTACTEUR À CLÉ

|               |  |
|---------------|--|
| <b>480886</b> | TYPHOON STALKER NRG (entourage barillet) canon |
|---------------|--|



## CAPUCHON DE CONTACTEUR À CLÉ

|               |                                       |         |
|---------------|---------------------------------------|---------|
| <b>460353</b> | BOOSTER BW'S ->2003                   | blanc   |
| <b>390460</b> | BOOSTER BW'S ->2003                   | bleu    |
| <b>440145</b> | BOOSTER BW'S ->2003                   | carbone |
| <b>436147</b> | BOOSTER BW'S ->2003                   | chrome  |
| <b>390474</b> | BOOSTER BW'S ->2003                   | rouge   |
| <b>491488</b> | BOOSTER BW'S ->2003                   | noir    |
| <b>334199</b> | NITRO AEROX BOOSTER BW'S 2004->       | bleu    |
| <b>440123</b> | NITRO AEROX BOOSTER BW'S 2004->       | carbone |
| <b>334203</b> | NITRO AEROX BOOSTER BW'S 2004->       | chrome  |
| <b>334218</b> | NITRO AEROX BOOSTER BW'S 2004->       | rouge   |
| <b>491490</b> | NITRO AEROX BOOSTER BW'S 2004->       | noir    |
| <b>491489</b> | SPEEDFIGHT   VIVACITY   TREKKER   TKR | noir    |



## BOUCHON ESSENCE ANTIVOL (AVEC 2 CLÉS)

|               |                              |
|---------------|------------------------------|
| <b>333723</b> | NITRO AEROX->2013   RS1 gris |
| <b>490668</b> | KEEWAY F-ACT   FOCUS   RY8   |
| <b>490667</b> | NRG POWER                    |



## BOUCHON RÉSERVOIR ESSENCE (AVEC 2 CLÉS)

|               |                      |                  |
|---------------|----------------------|------------------|
| <b>462497</b> | NITRO   AEROX ->2013 | carbone brillant |
| <b>462498</b> | NITRO   AEROX ->2013 | carbone mat      |
| <b>381880</b> | NITRO   AEROX ->2013 | rouge            |



**TEKNIX**
**BOUCHON RÉSERVOIR ESSENCE (AVEC 2 CLÉS)**

|               |   |
|---------------|---|
| <b>479271</b> | X POWER TZR 2003 -> GPR 2004->2010 SC RS 2006->2010 |
| <b>490669</b> | XR7 XR6 RS2 MH RX50 RX50 R                          |
| <b>490670</b> | DT50 XLIMIT   |
| <b>490667</b> | DERBI DRD PROJ R  NRG POWER                         |
| <b>490666</b> | BETA RR   |
| <b>333723</b> | RS1 gris  |



490670



490667



490666



479271



490669

**TUN'R**
**BOUCHON ESSENCE ANTIVOL**

|               |                         |
|---------------|-------------------------|
| <b>371787</b> | DERBI SENDA NOIR ->1999 |
| <b>371791</b> | RIEJU RS1 SPIKE         |



371787



371791

**TUN'R**
**BOUCHON ESSENCE**

|               |             |       |
|---------------|-------------|-------|
| <b>476156</b> | DERBI SENDA | noir  |
| <b>476155</b> | DERBI SENDA | rouge |



476156



476155

**TUN'R**
**BOUCHON MISE À L'AIR LIBRE, RENIFLARD  
MOTOCROSS | QUAD | DIRT (X1)**

|               |         |        |
|---------------|---------|--------|
| <b>487565</b> | alu CNC | noir   |
| <b>487567</b> | alu CNC | or     |
| <b>487564</b> | alu CNC | argent |
| <b>487566</b> | alu CNC | bleu   |
| <b>487563</b> | alu CNC | rouge  |



487565



487567



487564



487566



487563



## CONTACTEUR À CLÉ

378982 FOXIFXR



## BOUCHON ESSENCE ANTIVOL

1424 103 modèle réservoir 3L7

252503 CIAO PX

195374 FOXIPGT 103 nouveau modèle réservoir 5L non vissé



1424



252503



195374



## BOUCHON ESSENCE

4074 MBK 51/103 VOGUE à visser (30mm)

643 102 (40mm)

3202 CIAO PX



4074



643



3202



## CONTACTEUR À LED

472436 bleu loquet rouge

472438 rouge loquet noir

472437 rouge loquet rouge



472436



472438



472437



**COUPE CIRCUIT**

**333685** anti-agression

**485627** racing magnétique



333685



485627



**ALARME UNIVERSELLE**

**475353** 2 télécommandes

**487534** audio système MP3|FM 2 télécommandes et 2 enceintes



475353



487534



**PORTE-CLÉ**

**480787** amortisseur chrome/rouge

**480785** pot échappement alu/carbone

**481473** bougie argent

**333905** piston bleu

**480786** roue scooter bleu

**493094** levier

**493095** menotte argent

**493096** 2 roues

**493155** clé à molette argent

**493157** décapsuleur noir



480787



480785



481473



480786



333905



493094



493095



493096



493155



493157



**PORTE-CLÉ**

**491066** bandan skull

**491067** zombie skull

**491069** girl skull

**491071** piston skull

**491072** joker skull

**494179** masque à gaz skull

**494180** faucheuse



491066



491067



491069



491071



491072



494179



494180

# LEVIER-POIGNÉE / LEVER-HANDLE



## TUN'R LEVIER DE FREIN PAIRE



**462506**

BOOSTER 1995->2000  
et 2004-> | STUNT | ROCKET |  
JOG R noir mat



**462504**

BOOSTER 1995->2000 et  
2004-> | STUNT | ROCKET |  
JOG R carbone brillant



**462505**

BOOSTER 1995->2000  
et 2004-> | STUNT | ROCKET |  
JOG R carbone mat



**465537**

BOOSTER 1995->2000  
et 2004-> | STUNT | ROCKET |  
JOG R blanc



**462507**

BOOSTER 1995->2000  
et 2004-> | STUNT | ROCKET |  
JOG R chrome



**465538**

BOOSTER SPIRIT |  
BW'S 1999->2003 blanc



**293422**

NITRO | AEROX carbone brillant



**475852**

NITRO | AEROX bleu



**462516**

LUDIX frein disque noir mat



**324851**

SPEEDFIGHT disque arrière AJP  
carbone

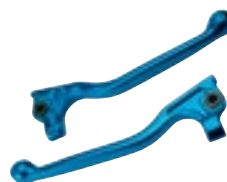

**324832**

SPEEDFIGHT disque arrière AJP  
bleu



**293786**

TREKKER | SPEEDFIGHT AJP  
tambour arrière carbone



**293752**

TREKKER | SPEEDFIGHT AJP  
tambour arrière bleu



**293771**

TREKKER | SPEEDFIGHT AJP  
tambour arrière rouge



**293577**

SR50 frein à disque arrière  
carbone



**293547**

SR50 frein à disque arrière bleu



## TUN'R LEVIER DE FREIN PAIRE



**450251**

STALKER tambour arrière  
carbone



**450252**

STALKER tambour arrière rouge



**450606**

STALKER | NRG | EXTREM  
disque arrière carbone



**450607**

STALKER | NRG | EXTREM  
disque arrière bleu



**450609**

STALKER | NRG | EXTREM  
disque arrière rouge



**293748**

TYPHOON ->2004 carbone



**293714**

TYPHOON ->2004 bleu



**455301**

NRG FREIN tambour arrière  
violet



## TEKNIX LEVIER DE FREIN



**189899**

BOOSTER NG 1999->20000 |  
ROCKET 1999->2000 (4SB)  
gauche



**4305**

BOOSTER ORIGINAL | BW'S  
->1995  
gauche



**4304**

BOOSTER | BW'S ->1995  
ORIGINAL  
droit



**211599**

BOOSTER ROAD ->1995->  
gauche



**211637**

BOOSTER ROAD ->1995->  
droit



**485313**

BOOSTER 1995->2000 2004-> |  
STUNT 2002-> | OVETTO 2007->  
gauche



**485314**

BOOSTER 1995->2000 2004-> |  
JOG R | STUNT 2002-> | ROCKET  
droit



**450626**





















NITRO | AEROX  
gauche ou droit



# LEVIER-POIGNÉE / LEVER-HANDLE



## LEVIER DE FREIN

|   |   |  |  |
|---|---|--|--|
|            |            |                |             |
| <b>450619</b><br>OVETTO   NEO'S 50  <br>100 1997->2006<br>gauche                            | <b>450620</b><br>OVETTO   NEO'S 50  <br>100 1997->2007<br>droit                             | <b>489325</b><br>OVETTO   NEO'S 2 temps 2007-><br>4 temps 2009->   NITRO AEROX<br>100CC<br>droit | <b>189857</b><br>LUDIX BLASTER SNAKE TREND<br>  SPEEDFIGHT   TREKKER  <br>VIVACITY<br>gauche   |
|            |            |                |             |
| <b>486351</b><br>LUDIX BLASTER SNAKE TREND<br>  SPEEDFIGHT   TREKKER  <br>VIVACITY<br>droit | <b>479145</b><br>LUDIX BLASTER SNAKE TREND<br>  SPEEDFIGHT   TREKKER  <br>VIVACITY<br>droit | <b>479144</b><br>LUDIX ONE   CLASSIC<br>PLASTIQUE<br>gauche                                      | <b>479143</b><br>LUDIX ONE   CLASSIC<br>PLASTIQUE<br>droit                                     |
|           |           |               |            |
| <b>450625</b><br>VIVACITY   SPEEDFIGHT  <br>SQUAB   ELYSEO   LOOXOR<br>droit                | <b>484315</b><br>PEUGEOT 50   125 TWEET<br>gauche   | <b>484314</b><br>50   125 TWEET   FIDDLE 2<br>droit  | <b>486235</b><br>KISBEE   VIVACITY 3  <br>SPEEDFIGHT<br>gauche                                 |
|          |          |              |           |
| <b>450663</b><br>DERBI SENDA avant 2001->  <br>SPEEDFIGHT AJP<br>droit ou gauche            | <b>189884</b><br>TYPHOON ->2004 2011->   ZIP<br>1993<br>gauche                              | <b>489324</b><br>TYPHOON 2005->2009   NRG<br>2005->   FLY   VESPA LX GT  <br>LIBERTY<br>gauche   | <b>489323</b><br>TYPHOON 2005->2009   NRG<br>2005->   FLY   RUNNER   VESPA<br>LX S GT<br>droit |
|          |          |              |           |
| <b>450622</b><br>ZIP 2 ET 4 TPS   SP   NRG  <br>STALKER   TYPHOON 2010-<br>>2012<br>gauche  | <b>479148</b><br>ZIP 4 temps   SP   NRG MC3<br>2001->2004   PURJET 2002-<br>>2005<br>droit  | <b>450623</b><br>ZIP 4temps   SP   RST   MC2  <br>NRG   NTT   MC3   STALKER<br>droit             | <b>450621</b><br>RUNNER   STALKER 2009->   SR<br>MOTARD 2012->   TYPHOON<br>2011-><br>droit    |



## LEVIER DE FREIN

**477449**AGILITY 50 | 125 2005->2007 |  
VITALITY 2004->2007

gauche

**477450**AGILITY 50 | 125 VITALITY 2004->  
2007

droit

**484952**SYM JET | FIDDLE II | ORBIT 50  
| 125

gauche

**484951**SYM JET | FIDDLE II | ORBIT 50  
| 125

droit

**484950**

SYM MIO 50 | 100

gauche

**484949**

SYM MIO 50 | 100

droit

**479141**KEEWAY FOCUS | HURRICANE |  
F-ACT | FLASH | MATRIX

gauche

**479142**KEEWAY FOCUS | HURRICANE |  
F-ACT | FLAH | MATRIX

droit

**485926**

SCOOTER CHINOIS | V-CLIC

gauche

**490482**SCOOTER CHINOIS | 139QMB |  
BT49QT | KISBEE 4 temps

droit

**491156**

TYPHOON 2001-&gt;2004

droit

**495191**

APRILIA SR50

gauche et droit

**495190**

APRILIA SR560

gauche et droit

**491997**

NITRO | AEROX 2013-&gt;

gauche et droit

**479147**ZIP 2000->2002 | SP | RST | C2 |  
NRG | NTT | MC3



## POIGNÉE DE FREIN GAUCHE

|        |   |  |
|--------|---|--|
| 211584 | BOOSTER ORIGINAL avec starter                 |  |
| 172734 | BOOSTER->2003   STUNT avec starter            |  |
| 465579 | BOOSTER NG                                    |  |
| 485556 | BOOSTER 2004->   BW'S 2004->   STUNT   SLIDER |  |
| 491460 | BOOSTER 2004->   BW'S 2004->   STUNT   SLIDER |  |
| 489268 | OVETTO   NEOS 1999->2006                      |  |
| 191020 | TYPHOON   NRG                                 |  |
| 485954 | ZIP 50  |  |



211584



172734



465579



485556



491460



489268



191020



485954



## POIGNÉE DE GAZ DROITE

|        |   |
|--------|---|
| 319880 | BOOSTER SPIRIT   BW'S                               |
| 489269 | BOOSTER   BW'S 2004->   NG 2000 ->   STUNT   SLIDER |
| 489270 | OVETTO   NEOS                                       |
| 485553 | TREKKER   VIVACITY   SPEEDFIGHT 2003->              |
| 3446   | TYPHOON   NRG                                       |
| 211618 | SR50  |



319880



489269



489270



485553



3446



211618

**TUN'R** LEVIER PAIRE

**450247**

DERBI GPR | XP6 carbone mat

**450246**

DERBI GPR | XP6 bleu

**450248**

DERBI GPR | XP6 rouge

**293532**

DERBI SENDA -&gt;1999 carbone



**451890**

 DERBI SENDA SM XTREM  
2002->2008 | SENDA R 2000  
carbone mat

**465575**

 DERBI SENDA SM XTREM  
2002->2008 | SENDA R 2000  
carbone

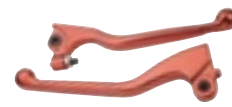
**451888**

 DERBI SENDA SM XTREM  
2002->2008 | SENDA R 2000  
bleu

**451889**

 DERBI SENDA SM XTREM  
2002->2008 | SENDA R 2000  
rouge

**293619**

RS50 -&gt;2000 carbone

**440005**

RS50 2001-&gt; carbone

**437966**

RS50 2001-&gt; rouge

**293528**

DERBI SENDA -&gt;1999 rouge

**497271**

 DERBI SENDA DRD  
PRO 2011-> argent

**497272**

 DERBI SENDA DRD PRO  
2011-> blanc

**497274**

 DERBI SENDA DRD PRO  
2011-> bleu

**497270**

 DERBI SENDA DRD PRO  
2011-> noir

**497273**

 DERBI SENDA DRD PRO 2011->  
rouge

**497228**

 DERBI SENDA SM | R RACE  
2003->2009 argent

**497232**

 DERBI SENDA SM | R RACE  
2003->2009 blanc

**497231**

 DERBI SENDA SM | R RACE  
2003->2009 bleu

# LEVIER-POIGNÉE / LEVER-HANDLE



**TUN'R** LEVIER PAIRE



**497233**

DERBI SENDA SM | R RACE  
2003->2009 carbone mat



**497229**

DERBI SENDA SM | R RACE  
2003->2009 noir



**497230**

DERBI SENDA SM | R RACE  
2003->2009 rouge



**497261**

RIEJU MRT 2009-> AJP argent



**497264**

RIEJU MRT 2009-> AJP blanc



**497263**

RIEJU MRT 2009-> AJP bleu



**497260**

RIEJU MRT 2009-> AJP noir



**497262**

RIEJU MRT 2009-> AJP rouge



**497266**

RIEJU MRT 2011-> argent



**497267**

RIEJU MRT 2011-> blanc



**497269**

RIEJU MRT 2011-> bleu



**497265**

RIEJU MRT 2011-> noir



**497268**

RIEJU MRT 2011-> rouge



**497276**

SHERCO 2011-> argent



**497277**

SHERCO 2011-> blanc



**497279**

SHERCO 2011-> bleu



**497275**

SHERCO 2011-> noir



**497278**

SHERCO 2011-> rouge



## LEVIER DE FREIN

**264355**RS50 1999->2005 | TUONO  
2003->2005 | 125 TUONO**483510**RS50 2006->2009 | GPR 50 | 125  
2004->2009 | SC 125**483514**TZR | X POWER 50 1996->2003 |  
TZR 125 1990->1995**483515**X LIMIT | DT50 R 2004->2009 |  
SM 2006->2009**481728**X LIMIT | DT50 R ET SM  
2004->2009**480108**

X POWER | TZR 50 2003-&gt;

**450615**BOOSTER 1995->2000 2004-> |  
JOG R | STUNT 2002-> | ROCKET**480109**RS1 | MRX | MRX PRO  
(00-07) | GPR | RRX SPIKE |  
SMX | SHERCO**483512**

















RS2 50 | 125 | XR6

**483511**BETA RR 2005->2008 | TRACK  
2008->**483513**DERBI SENDA DRD PRO 2005-> |  
RIEJU MRT 2009-> | SHERCO  
AJP**482743**SEDA DRD PRO | GPR 10-> |  
BETA RR | RS4 | SHERCO | XPS |  
XR7 | NK7**450662**DERBI SENDA DRD | GAS GAS  
TRIAL**465571**SEDA DRD PRO AJP | BETA  
RR-SM | XP6 | XPS | RIEJU AJP |  
SHERCO**485773**DERBI SENDA DRD PRO 2011-> |  
RIEJU MRT PRO | SHERCO**450663**DERBI SENDA avant 2001-> |  
SPEEDFIGHT AJP**492263**DERBI SENDA DRD PRO 2011-> |  
RIEJU MRT PRO



**TEKNIX**

## LEVIER D'EMBRAYAGE

|  |  |  |   |
|--|--|--|---|
|                               |                           |                    |                              |
| <p><b>264427</b><br/>RX50 1997-&gt;2002   RS50<br/>1996-&gt;1998   BETA RR<br/>1997-&gt;1999</p>               | <p><b>264360</b><br/>RS50 1998-&gt;2005   TUONO 125<br/>2001-&gt;2002</p>                                  | <p><b>483508</b><br/>RS50 2006-&gt;2009   RS4 50 125  <br/>GPR 2005-&gt;2009 50   125</p>            | <p><b>483507</b><br/>X LIMIT   DT50 R<br/>et SM 1996-&gt;2003</p>   |
|                               |                           |                    |                              |
| <p><b>479139</b><br/>X LIMIT   DT50 R ET SM 2003-&gt;  <br/>SENDA DRD 2001-&gt;2003</p>                        | <p><b>483506</b><br/>X POWER   TZR 50 1996-&gt;2003  <br/>TZR 125 1990-&gt;1995</p>                        | <p><b>479140</b><br/>X POWER   TZR 50 2003-&gt;</p>  | <p><b>264412</b><br/>RIEJU RS1   RS2 MATRIX   RS3  <br/>SMX   RMX   MRX 2005-&gt;2007  <br/>SHERCO</p>          |
|                             |                         |                  |                            |
| <p><b>485226</b><br/>RIEJU MRT 2009-&gt;</p>   | <p><b>483509</b><br/>BETA RR 2005-&gt;2008   RR<br/>TRACK 08-&gt;   SHERCO 2006-<br/>&gt;2010 50   125</p> | <p><b>450665</b><br/>DERBI SENDA DRD   GPR 50&gt;03<br/>  FENIX 50   RIEJU MRX   RRX  <br/>SPIKE</p> | <p><b>450664</b><br/>SENDA L   R   SM   DT50 &gt;02  <br/>XP6   RIEJU RMX-SMX   SUZUKI<br/>2001-&gt;   BETA</p> |
|                             |                         |                  |                            |
| <p><b>486992</b><br/>SENDA DRD PRO   RACING<br/>2004-&gt;2008   RS50 TUONO<br/>2003-&gt;2004   RX50   SX50</p> | <p><b>485772</b><br/>SHERCO 2004-&gt;2006</p>  | <p><b>492262</b><br/>BETA RR 50 ENDURO  <br/>SM 2005-&gt;2008</p>                                    | <p><b>492278</b><br/>SHERCO 50 SE-R   SM-R</p>  |



Sélection  
**CGN**

## POIGNÉE DE GAZ



**465570**

DERBI SENDA | SUZUKI RMX |  
SMX



**264499**

RIEJU RS1 | R S2 MATRIX | XR6  
2002 | 2003 | RS3



**465567**

RIEJU SMX-R MX | SPIKE |  
TANGO | MRT | RRX



**172768**

RS50 | XP6



**465569**

X-POWER | TZR 50



**465568**

XPS | XR6 | XP6



**264389**

BETA RR 1999->2004 | GSM |  
RIEJU SMX | RMX



**264457**

DERBI SENDA DRD



**465564**

DERBI SENDA L | R | SM



**264408**

RIEJU RR | SPIKE | MRX | SMX |  
MRT | RRX



**264484**

RIEJU RS1



**264374**

RS50 ->1998 | X-LIMIT | SUZUKI  
RMX | SM



**264465**

RX50 1997->



**264393**

RX50 ->1996



**264537**

XP6



**465566**

X-POWER | TZR 50





## POIGNÉE D'EMBRAYAGE UNIVERSELLE

494441 noir levier argent



## POIGNÉE D'EMBRAYAGE

485552 RS1 | RS2 | XR6 | GPR 2001 | RS3



## LEVIER DE FREIN



911

103 SPX | RCX  
gauche



912

103 SPX | RCX  
droit



907

103 | FOX | VOGUE | SPX | MVL M  
gauche et droit



3443

CIAO PX 1989->  
gauche

## POIGNÉE DE FREIN



902

Sélection  
**CGN**

103 CLB AM  
gauche



909

Sélection  
**CGN**

103 SPX | RCX avec starter  
gauche



910

Sélection  
**CGN**

103 SPX | RCX  
droit



480978

Sélection  
**CGN**

103 PGT NM  
gauche



211570

Sélection  
**CGN**

MBK 51 EVASION | PASSION |  
SWING | MAGNUM  
gauche



4298

Sélection  
**CGN**

MBK 51 avec starter  
gauche



3438

Sélection  
**CGN**

CIAO PX 1989-> avec starter  
gauche



197855

Sélection  
**CGN**

MBK CLUB 1988->1989 avec  
starter  
gauche



## POIGNÉE DE FREIN



489271



FOX | FXR  
gauche

Selection  
**CGN** POIGNÉE DE GAZ



480977

103 PGT NM



901

103 CLB AM



211622

MBK 51 EVASION PASSION |  
SWING | MAGNUM



4297

51 MBK



3439

CIAO PX 1989-&gt;



197847

MBK CLUB 1988->1989  
avec levier décompresseur

**TUN'R** LEVIER DE DÉCOMPRESSEUR



3100

chrome métal



3099

noir métal



462116

alu argent



496092

chrome métal (x2)



## TUN'R LEVIER DE FREIN ALU (PAIRE)



**3102**  
chrome court



**3101**  
chrome long



**492599**  
noir court



**492598**  
noir long

## TUN'R LEVIER, POIGNÉE



**3132**  
MINI TARGA



**179136**  
MINI TARGA noir



**3142**  
MINI TARGA luxe chrome kit  
métal



## TUN'R POIGNÉE DE GAZ



**484664**  
alu CNC argent avec vis creuse  
10x125



**484665**  
alu CNC noir avec vis creuse  
10x125



**489388**  
alu CNC or avec vis creuse  
10x125



**489387**  
alu CNC rouge avec vis creuse  
10x125



**451779**  
alu CNC bleu avec vis creuse  
10x125



**460101**  
alu noir



**460102**  
CROSS | PIT BIKE | DIRT noir



**483720**  
MINI TARGA plastique noir



**TUN'R** POIGNÉE DE GAZ



**3087**

MINI TARGA chrome

**3085**

TARGA

**219590**

TARGA métal noir

**3091**

TYPE DOMINO chrome



**492600**

MINI TARGA noir tirage droit

**494341**

type DOMINO alu noir

**domino** POIGNÉE DE GAZ



**490363**

QUAD DOMINO à gachette

**245524**

DOMINO racing noir

**3090**

DOMINO zamac noir



**MOUSSE DE LEVIER DE FREIN 100MM (PAIRE)**

**461611** noir/bleu

**461610** noir/rouge



461611



461610

## PIÈCES DÉTACHÉES

| PIÈCES DÉTACHÉES |  |   |
|------------------|--|---|
| 480979           | navette/curseur poignée de gaz 103 CLB                           |    |
| 486421           | navette/curseur poignée de gaz                                   |    |
| 481505           | levier de décompresseur CIAO PX/BRAVO/SI 2004-> long noir        |     |
| 480980           | levier décompresseur droit 103 PGT AM CLB                        |     |
| 480981           | levier starter CLB gauche 103 PGT AM                             |    |
| 3089             | couvercle poignée de gaz TARGA                                   |     |
| 297322           | vis creuse poignée M8x125 pour gaine 6                           |     |
| 486423           | barrillet/tourillon pour poignée de gaz/embrayage (grand modèle) |    |
| 486422           | barrillet/tourillon pour poignée de gaz/embrayage (petit modèle) |    |
| 481264           | vis creuse poignée M10x125 alu fendu (gaz)                       |    |
| 8886             | vis creuse poignée M5x0.80 x1                                    |    |
| 482401           | vis creuse poignée M6x100 fendu pour gaine 6mm x1                |    |
| 8887             | vis creuse poignée M6x100 non fendu pour gaine 7mm x1            |   |
| 8885             | vis creuse poignée M6x100 pour gaine 6mm x1                      |  |
| 297322           | vis creuse poignée M8x125  |   |
| 3106             | vis creuse poignée M7x100  |   |
| 492595           | vis creuse poignée M7x100 pour gaine 6mm                         |  |
| 498268           | vis creuse poignée M6x100 fendue pour gaine 7 mm                 |  |
| 483055           | ressort de levier droit frein PEUGEOT/MBK                        |  |
| 490365           | ressort de levier gauche frein/embrayage PEUGEOT                 |   |



480979



480980



486422



481264



483055















### LEVIER DE STARTER

211603 BOOSTER | DERBI SENDA gachette



# LEVIER-POIGNÉE / LEVER-HANDLE

## COMMODO

|  |  |   |  |
|--|--|---|--|
|  <p><b>476756</b></p>   |  <p><b>476757</b></p>   |  <p><b>482380</b></p>   |  <p><b>482379</b></p>   |
| <p><b>TEKNIX</b></p> <p>complet BOOSTER   BW'S 2000<br/>droit</p>  | <p><b>TEKNIX</b></p> <p>complet BOOSTER   BW'S -&gt;2000<br/>STARTER CABLE<br/>gauche</p>                | <p><b>TEKNIX</b></p> <p>BOOSTER NEXT   ROCKER  <br/>STUNT (5JHH)<br/>gauche</p>                           | <p><b>TEKNIX</b></p> <p>BOOSTER 2004-&gt;   BOOSTER<br/>1999-&gt;2003   STUNT 2004<br/>gauche</p>          |
|  <p><b>482381</b></p>   |  <p><b>482382</b></p>   |  <p><b>487962</b></p>   |  <p><b>487963</b></p>   |
| <p><b>TEKNIX</b></p> <p>BOOSTER 1999-&gt;2003   NEXT  <br/>ROCKET-&gt;2004   STUNT<br/>droit</p>         | <p><b>TEKNIX</b></p> <p>BOOSTER   BW'S 2004-&gt;  <br/>STUNT   SLIDER 2004-&gt;<br/>droit</p>            | <p><b>TEKNIX</b></p> <p>NITRO   AEROX 2004-&gt;2013<br/>droit</p>   | <p><b>TEKNIX</b></p> <p>NITRO   AEROX 2004-&gt;2013<br/>gauche</p>   |
|  <p><b>485877</b></p>  |  <p><b>485878</b></p>  |  <p><b>485951</b></p>  |  <p><b>485952</b></p>  |
| <p><b>TEKNIX</b></p> <p>KEEWAY F-ACT   MATRIX   RY8<br/>complet<br/>gauche</p>                           | <p><b>TEKNIX</b></p> <p>KEEWAY F-ACT   MATRIX   RY8<br/>droit</p>  | <p><b>TEKNIX</b></p> <p>KISBEE   VIVACITY 3  <br/>SPEEDFIGHT<br/>gauche</p>                               | <p><b>TEKNIX</b></p> <p>KISBEE   VIVACITY 3  <br/>SPEEDFIGHT 3<br/>droit</p>                               |
|  <p><b>485955</b></p> |  <p><b>485925</b></p> |  <p><b>484270</b></p> |  <p><b>484272</b></p> |
| <p><b>TEKNIX</b></p> <p>ZIP 50 kit 5 pièces</p>  | <p><b>TEKNIX</b></p> <p>SCOOTER CHINOIS   V-CLIC  <br/>GY6</p>   | <p><b>Sélection CGN</b></p> <p>SPEEDFIGHT   TREKKER  <br/>VIVACITY<br/>gauche</p>                         | <p><b>Sélection CGN</b></p> <p>SPEEDFIGHT   TREKKER  <br/>VIVACITY<br/>droit</p>                           |
|  <p><b>484271</b></p> |  <p><b>485548</b></p> |   |  |
| <p><b>Sélection CGN</b></p> <p>DERBI SENDA<br/>gauche</p>  | <p><b>TOMMABELLI</b></p> <p>X-POWER   TZR<br/>gauche</p>   |   |  |

## COMMODO UNIVERSEL



476758

**TUN'R**

noir avec bouton on/off



484273

Sélection  
**CGN**

noir avec bouton on/off



### COMMODO PARTIE ARRIÈRE AVEC SUPPORT RÉTROVISEUR

491463 MBK | YAMAHA droit

491461 MBK | YAMAHA gauche



491463



491461



### COMMODO PARTIE ARRIÈRE GAUCHE

487249 SPEEDFIGHT | TREKKER | VIVACITY | XP6 | XR6

487250 DERBI SENDA

487252 MBK | YAMAHA avec support rétroviseur



487249



487250



487252



### AVERTISSEUR, KLAXON

335161 tous modèles 12V

485178 tous modèles 12V chrome

450783 BOOSTER | SPEEDFIGHT | SR50

496478 tous modèles 6V



335161



485178



450783



496478

## COMMODO UNIVERSEL

Sélection  
**CGN****BOUTON POUSSOIR AVERTISSEUR**

482017 avec fil et collier, mise à la masse

Sélection  
**CGN****CONTACTEUR DE STOP**

319894 F10 | F15 clipsable Ø8.5mm

479116 gris avec vis

252609 Ø6mm

487834 arrière hydraulique M10x1.00mm x1

487833 arrière hydraulique M10x1.25 x1

487248 pour maître cylindre universel | KYMCO | SYM



319894



479116



252609



487834



487833



487248

Sélection  
**CGN****CONTACTEUR INTÉRRUPTEUR**

479824 à levier petit modèle

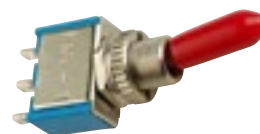

TEKNIX

**CONTACTEUR INTÉRRUPTEUR**

479499 on/off encastrable







## GRIP RADICAL

- 497281 blanc | bleu
- 487279 blanc | noir
- 497280 blanc | rouge
- 497282 blanc | vert
- 487280 noir | blanc
- 487284 noir | bleu
- 490420 noir | jaune
- 487282 noir | orange
- 490422 noir | rose fluo
- 487283 noir | rouge
- 487281 noir | vert

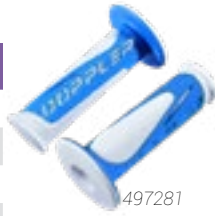

497281



487279



497280



497282



487280



487284



490420



487282



490422



487283



487281



## GRIP CONCEPT

- 483908 noir | blanc
- 483910 noir | gris
- 483909 noir | rouge



483908



483910



483909



## GEL GP

- 496361 noir | bleu
- 496362 noir | jaune
- 496363 noir | rouge
- 496364 noir | vert



496361



496362



496363



496364



## DESIGN

- 476400 bleu clair | gris





**COLOR**

- 496886 jaune fluo | gris
- 468271 noir | blanc
- 468272 noir | gris
- 468273 noir | orange
- 468274 noir | rouge



**POLAR**

- 468276 blanc | noir



**732**

- 484527 blanc | noir
- 484531 bleu | noir
- 484530 noir | blanc
- 490302 noir | orange
- 493945 noir | orange
- 489530 noir | rose fushia
- 484528 rouge | noir
- 484529 vert | noir



**788**

- 490097 blanc | noir
- 490094 bleu | blanc
- 490096 noir | blanc
- 490093 orange | blanc
- 490095 rouge | blanc
- 490092 vert | blanc





## 801

- 484523** blanc | noir
- 484524** gris | bleu
- 492059** noir | jaune fluo
- 492060** noir | orange fluo
- 492058** noir | vert fluo



484523



484524



492059



492060



492058

## ROAD 728 BAGUE ALU

- 482176** noir | argent
- 482178** noir | bleu
- 482177** noir | or
- 482179** noir | rouge



482176



482178



482177



482179

## 761

- 440917** noir



## 768

- 266893** noir | jaune



## 789

- 166857** noir



## 794

- 486800** jaune fluo
- 460731** noir
- 486799** orange fluo
- 486801** rose fluo
- 486802** vert fluo



486800



460731



486799



486801



486802



### CROSS/ENDURO 120MM

- 482910 noir | gris
- 482909 noir | orange
- 482908 noir | rouge
- 482907 noir | vert



### CROSS DOUBLE DENSITÉ 118MM

- 490376 bleu | blanc
- 490374 noir | gris
- 490373 noir | jaune
- 490372 noir | orange
- 490371 noir | rouge
- 490375 noir | vert



### TYPE ORIGINE NOIR 120MM

- 493944 type YAMAHA
- 493946 type HONDA
- 493945 type SUZUKI



### A350 TURISMO DÉBOUCHÉ POUR EMBOUT GUIDON

- 496023 noir | bleu
- 496025 noir | gris
- 496022 noir | marron
- 496026 noir | orange
- 496021 noir | rouge
- 496024 noir | vert



### VINTAGE 120MM

- 490364 marron





## CHALLENGER

- 491227 noir | bleu
- 491229 noir | gris
- 491224 noir | jaune
- 491226 noir | orange
- 491228 noir | rouge
- 491225 noir | vert



491227



491229



491224



491226



491228



491225



## AXIOM TRIPLE DENSITÉ

- 496005 noir | bleu
- 496009 noir | gris
- 496010 noir | jaune
- 496008 noir | orange
- 496007 noir | rouge
- 496006 noir | vert



496005



496009



496010



496008



496007



496006



## ROADER

- 482897 blanc | noir
- 482892 noir | blanc
- 482891 noir | bleu
- 482895 noir | gris
- 482893 noir | orange
- 482896 noir | rouge
- 482894 noir | vert



482897



482892



482891



482895



482893



482896



482894



## CÔNE

- 487417** noir cône blanc
- 292096** noir cône bleu
- 292120** noir cône chrome
- 481472** noir cône noir
- 291654** noir cône or
- 292107** noir cône rouge
- 335821** transparent cône carbone



487417



292096



292120



481472



291654



292107



335821

## FLAMING GEL

- 484711** noir flamme blanche
- 461616** noir flamme orange
- 461613** noir flamme rouge



484711



461616



461613

## GRIP

- 479262** blanc | noir
- 479240** noir | blanc
- 479241** noir | bleu
- 479243** noir | gris
- 479242** noir | rouge



479262



479240



479241



479243



479242

## SKULL

- 493991** noir | blanc
- 493992** noir | rouge
- 493994** orange | blanc
- 493993** vert | blanc



493991



493992



493994



493993



## CROSS BI COULEUR

- 494238 gris | bleu
- 494239 gris | noir
- 494237 gris | orange
- 494240 gris | rouge
- 494235 gris | vert
- 494243 noir | bleu
- 494242 noir | orange
- 494244 noir | rouge
- 494241 noir | vert



## 120MM

- 494087 noir



## MOTOCROSS

- 487286 blanc
- 487290 bleu fluo
- 487287 orange fluo
- 487291 rose fluo
- 487288 vert fluo



## TOP GRIP

- 334404 noir | vert



## CONFORT

- 482867 imitation carbone, embout chrome



## CROSS

- 489982 jaune



## SCOOTER ET CYCLO 115MM

- 486985 noir



## CYCLO 110MM

- 494095 103 CLB AM noir





## APRILIA



391026

RALLY Ø8mm carbone  
droit

391037

RALLY Ø8mm carbone  
gauche

496687

SR MOTARD  
droit

496686

SR MOTARD  
gauche

496689

SR FACTORY 2005->  
droit

496688

SR FACTORY 2005->  
gauche

## DERBI



496689

VARIANT 2012->  
droit

496688

VARIANT 2012->  
gauche

495373

GP1  
droit

495372

GP1  
gauche

## KEEWAY | CPI



480791

KEEWAY FOCUS | F-ACT  
droit

480792

KEEWAY FOCUS | F-ACT  
gauche

479216

KEEWAY FOCUS | MATRIX |  
F-ACT  
droit

479215

KEEWAY FOCUS | MATRIX |  
F-ACT  
gauche



# RÉTROVISEUR / WING MIRROR



## KEEWAY | CPI



**483983**

KEEWAY FOCUS | F-ACT  
droit



**483984**

KEEWAY FOCUS | F-ACT  
gauche



**479216**

KEEWAY FOCUS  
droit



**479215**

KEEWAY FOCUS  
gauche



**483983**

KEEWAY FOCUS | MATRIX  
droit



**483984**

KEEWAY FOCUS | MATRIX  
gauche

## KYMCO



**482364**

DINK 50 | 125 | SUPER DINK  
droit



**482363**

DINK 50 | 125 | SUPER DINK  
gauche



**479217**

AGILITY  
paire



**484955**

AGILITY 50  
gauche

## MBK | YAMAHA



**2494**

BOOSTER | BW'S  
droit



**2495**

BOOSTER | BW'S  
gauche



**176497**

BOOSTER | BW'S | NG | ROCKET |  
OVETTO | NEOS  
droit



**176539**

BOOSTER | BW'S | NG | ROCKET |  
OVETTO | NEOS  
gauche



## MBK | YAMAHA

|   |  |   |  |
|---|--|---|--|
| <br><b>TEKNIX</b><br><b>265662</b><br>NITRO   AEROX<br>droit                                 | <br><b>TEKNIX</b><br><b>265658</b><br>NITRO   AEROX<br>gauche                                 | <br><b>Vicma</b><br><b>455258</b><br>BOOSTER<br>droit       | <br><b>Vicma</b><br><b>449804</b><br>BOOSTER   BW'S<br>gauche |
| <br><b>Vicma</b><br><b>449803</b><br>BOOSTER NG   STUNT   SLIDER  <br>OVETTO   NEOS<br>droit | <br><b>Vicma</b><br><b>455280</b><br>BOOSTER NG   STUNT   SLIDER  <br>OVETTO   NEOS<br>gauche | <br><b>Vicma</b><br><b>455260</b><br>NITRO   AEROX<br>droit | <br><b>Vicma</b><br><b>449805</b><br>NITRO   AEROX<br>gauche  |

## PEUGEOT

|  |   |   |  |
|--|---|---|--|
| <br><b>TEKNIX</b><br><b>466579</b><br>LUDIX ELEGANCE<br>gauche      | <br><b>TEKNIX</b><br><b>390967</b><br>VIVACITY   LOOXOR 50<br>gauche | <br><b>TEKNIX</b><br><b>477504</b><br>SQUAB   TREKKER<br>droit              | <br><b>TEKNIX</b><br><b>176543</b><br>SQUAB   TREKKER<br>gauche |
| <br><b>TEKNIX</b><br><b>451787</b><br>SPEEDFIGHT noir<br>réversible | <br><b>TEKNIX</b><br><b>477505</b><br>LUDIX<br>réversible            | <br><b>TEKNIX</b><br><b>441317</b><br>SPEEDFIGHT carbone Ø8mm<br>réversible | <br><b>Vicma</b><br><b>488134</b><br>SPEEDFIGHT ->1998<br>droit |



**PEUGEOT**



**465494**

LUDIX SNAKE TREND ELEGANCE  
| VIVACITY 3  
droit



**465493**

LUDIX SNAKE TREND ELEGANCE  
| VIVACITY  
gauche



**390997**

SPEEDFIGHT WRC | TREKKER  
METAL-X | X-RACE  
droit



**391007**

SPEEDFIGHT WRC | TREKKER  
METAL-X | X-RACE  
gauche



**455269**

SPEEDFIGHT 1998->  
droit



**455289**

SPEEDFIGHT 1998->  
gauche



**484953**

KISBEE | VIVACITY 3  
droit



**484954**

KISBEE | VIVACITY 3  
gauche



**455266**

VIVACITY | LOOXOR 50 2000->  
droit



**455286**

VIVACITY | LOOXOR 50 2000->  
gauche



**455267**

ELYSEO 50 | 125  
droit



**455283**

ELYSEO 50 | 125  
gauche



**455296**

JET FORCE 50  
gauche



**455285**

SQUAB | TREKKER OFF ROAD  
gauche



**455265**

TREKKER 2000->  
droit





**455288**







SQUAB | TREKKER M8x125  
gauche



## PEUGEOT













|   |   |  |   |   |
|---|---|--|---|---|
|  |  |  |  |   |
| <b>482557</b>   | <b>482558</b>   | <b>455270</b>  | <b>455290</b>   |   |
| PEUGEOT V CLIC<br>droit   | PEUGEOT V CLIC<br>gauche  | ELYSTAR 50   100   125   150<br>droit  | ELYSTAR 50   100   125   150<br>gauche  |   |
|  |  |   |   |  |
| <b>485703</b>   | <b>485704</b>   | <b>465492</b>  | <b>498243</b>   | <b>498244</b>   |
| PEUGEOT 50   125 TWEET<br>droit   | PEUGEOT 50   125 TWEET<br>gauche  | LUDIX ONE CLASSIC<br>réversible  | SPEEDFIGHT3 2009-><br>droit   | SPEEDFIGHT3 2009-><br>gauche  |

## PIAGGIO | GILERA

|   |   |  |   |
|---|---|--|---|
|  |  |  |   |
| <b>2503</b>   | <b>482366</b>   | <b>482365</b>  |   |
| TYPHOON<br>gauche   | LIBERTY 50   125   LX 50   125<br>chrome<br>droit                                   | LIBERTY 50   125   LX 50   125<br>chrome<br>gauche                                   |   |
|  |  |  |  |
| <b>479216</b>   | <b>479215</b>   | <b>480778</b>  | <b>480777</b>   |
| PIAGGIO ZIP 50 2009-><br>droit  | PIAGGIO ZIP 50 2009-><br>gauche   | STALKER GILERA<br>droit  | STALKER GILERA<br>gauche  |



## PIAGGIO | GILERA

|   |   |  |   |
|---|---|--|---|
|  <p><b>Vicma</b></p>   |  <p><b>Vicma</b></p>   |  <p><b>Vicma</b></p>   |  <p><b>Vicma</b></p>   |
| <p><b>449786</b><br/>TYPHOON   NRG   NTT<br/>1995-&gt;2005<br/>gauche</p>                               | <p><b>496687</b><br/>TYPHOON 2011-&gt;   NEXUS 125<br/>droit</p>  | <p><b>496686</b><br/>TYPHOON 2011-&gt;   NEXUS 125<br/>gauche</p>  | <p><b>482238</b><br/>PIAGGIO LIBERTY 50   125<br/>gauche</p>  |
|  <p><b>Vicma</b></p>   |  <p><b>Vicma</b></p>   |  <p><b>Vicma</b></p>   |   |
| <p><b>483983</b><br/>ZIP 50 2009-&gt;<br/>droit</p>   | <p><b>483984</b><br/>ZIP 50 2009-&gt;<br/>gauche</p>  | <p><b>455293</b><br/>NRG MC2-MC3-EXTREME  <br/>PURJET   ZIP 1995-&gt;2005<br/>gauche</p>                 |   |
|  <p><b>Vicma</b></p> |  <p><b>Vicma</b></p> |  <p><b>Vicma</b></p> |  <p><b>Vicma</b></p> |
| <p><b>455276</b><br/>STALKER<br/>droit</p>  | <p><b>288044</b><br/>STALKER<br/>gauche</p>   | <p><b>455274</b><br/>RUNNER 1997-&gt;2004<br/>droit</p>  | <p><b>455294</b><br/>RUNNER 1997-&gt;2004<br/>gauche</p>  |
|  <p><b>Vicma</b></p> |  <p><b>Vicma</b></p> |  |   |
| <p><b>481224</b><br/>VESPA LX 50   125   PIAGGIO<br/>LIBERTY 50   12<br/>droit</p>                      | <p><b>481225</b><br/>VESPA LX 50   125   PIAGGIO<br/>LIBERTY 50   125<br/>gauche</p>                    |  |   |

RÉTROVISEUR / WING MIRROR



**SYM**



**482362**

SYM M10  
gauche



**Vicma**

**494454**

SYM EURO JET 50  
gauche



**Vicma**

**478623**

SYM EURO JET 50  
droit



**Vicma**

**485705**

SYM 50 | 125 FIDDLE II  
droit



**Vicma**

**485706**

SYM 50 | 125 FIDDLE II  
gauche



**APRILIA**



**Vicma**

**455262**

RS50 | 125 | 250 1997->2010  
droit



**Vicma**

**455282**

RS50 | 125 | 250 1997->2010  
gauche



**Vicma**

**486996**

RS4 50 | 125 | RS 125  
2006->2010  
droit

**Vicma**

**486997**

RS4 50 | 125 | RS 125  
2006->2010  
gauche

**DERBI**



**Vicma**

**485119**

GPR 2004->2009 50 | 125 | SC  
125  
droit



**Vicma**

**485120**

GPR 2004->2009 50 | 125 | SC  
125  
gauche

# RÉTROVISEUR / WING MIRROR



## DERBI

|  |  |   |
|--|--|---|
|  <p><b>288059</b></p> |  <p><b>288063</b></p> |  <p><b>288078</b></p> |
| <p>SENDA 2000-&gt;<br/>gauche</p>  | <p>DERBI GPR 50 1997-&gt;2003<br/>droit</p>  | <p>DERBI GPR50 1997-&gt;2003<br/>gauche</p>   |

---

|  |  |   |  |
|--|--|---|--|
|  <p><b>486125</b></p> |  <p><b>486126</b></p> |  <p><b>455263</b></p> |  <p><b>332416</b></p> |
| <p>DERBI SENDA SM   DRD PRO  <br/>EVO 2005-&gt;2009<br/>droit</p>                                      | <p>SENDA SM   DRD PRO   EVO<br/>2005-&gt;2009<br/>gauche</p>   | <p>SENDA<br/>réversible</p>   | <p>SENDA R 2000-&gt;<br/>réversible</p>  |

## MBK | YAMAHA

|  |  |   |
|--|--|---|
|  <p><b>465504</b></p> |  <p><b>465503</b></p> |  <p><b>467917</b></p> |
| <p>X-POWER   TZR 50 2003-&gt;<br/>droit</p>  | <p>X-POWER   TZR 50 2003-&gt;<br/>gauche</p>   | <p>X POWER   TZR 50 carbone<br/>droit</p>   |

## PEUGEOT | MH

|  |  |   |  |
|--|--|---|--|
|  <p><b>479219</b></p> |  <p><b>479218</b></p> |  <p><b>465498</b></p> |  <p><b>465497</b></p> |
| <p>PEUGEOT XP6   XPS   XP7   NK7<br/>droit</p>   | <p>PEUGEOT XP6   XPS   XP7   NK7<br/>gauche</p>  | <p>XP6   XPS   XP7   NK7<br/>droit</p>  | <p>XP6   XPS   XP7<br/>gauche</p>  |

RÉTROVISEUR / WING MIRROR



PEUGEOT | MH



**Vicma** MATRIX

**455275**

XR6  
droit



**Vicma** MATRIX

**455295**

XR6  
gauche



**Vicma** MATRIX

**483731**

XR7 2011-> | MH RX50 R  
droit



**Vicma** MATRIX

**483730**

XR7 2011-> | MH RX50 R  
gauche



**Vicma** MATRIX

**495373**

XPS | XPS STREET EVO3 | DERBI  
GP1  
droit



**Vicma** MATRIX

**495372**

XPS | XPS STREET EVO3 | DERBI  
GP1  
gauche

RIEJU



**Vicma** MATRIX

**465500**

RIEJU RS2 MATRIX  
droit



**Vicma** MATRIX

**465499**

RIEJU RS2 MATRIX  
gauche



**Vicma** MATRIX

**491325**

RIEJU MRT | M RX | RRX |  
TANGO | SMX



**Vicma** MATRIX

**288169**

RIEJU RS1 1989->1997  
gauche



**Vicma** MATRIX

**485117**

RIEJU RS3 50 | 125  
droit



**Vicma** MATRIX

**485118**

RIEJU RS3 50 | 125  
gauche



## RÉTROVISEUR / WING MIRROR



RIEJU



Vicma INDUSTRIES

455275

XR6 | RIEJU RS1 EVOLUTION  
1998->2003

droit



Vicma INDUSTRIES

455295

XR6 | RIEJU RS1 EVOLUTION  
1998->2003

gauche



Vicma INDUSTRIES

455275

RS1 EVOLUTION 1998-&gt;2003

droit



Vicma INDUSTRIES

455295

RS1 EVOLUTION 1998-&gt;2003

gauche

SUZUKI



Vicma INDUSTRIES

465501

SUZUKI RMX-SMX 1999-&gt;

## RÉTROVISEURS



Vicma INDUSTRIES

449790\*

F1 italien fixation/carénage  
carbone clignotant  
droit

Vicma INDUSTRIES

449791\*

F1 italien fixation/carenage  
carbone clignotant  
gauche

TUN'R

478307\*

LOOK Ø8mm noir tige longue  
paire

TUN'R

441329\*

F1 italien fixation/carenage  
carbone avec clignotantSelection  
CGN

462617\*

universel multiposition noir à  
collier tige Ø8mm avec rotules  
paire

Vicma INDUSTRIES

208027

chrome Ø8mm  
droit

Vicma INDUSTRIES

208012

chrome Ø8mm  
gauche

Vicma INDUSTRIES

496329

universel réglable en hauteur  
avec collier  
réversible

\*Produits destinés à des concours tuning, usage interdit sur la voie publique.



## RÉTROVISEURS

|  |  |  |   |
|--|--|--|---|
| <br><b>Vicma</b><br><b>440809</b> | <br><b>Vicma</b><br><b>195245</b> | <br><b>Vicma</b><br><b>717</b> | <br><b>TEKNIX</b><br><b>441316</b> |
| 103 MVL   VOGUE   SP<br>gauche   | collier rond chrome Ø8mm<br>réversible   | collier rond noir<br>universel   | FOX<br>gauche   |

|   |  |
|---|--|
| <br><b>TEKNIX</b><br><b>480793</b> | <br><b>Vicma</b><br><b>486350</b> |
| noir avec collier forme zip<br>paire  | VELOFAX 50   VESPINO F18<br>gauche   |



|   |   |  |   |
|---|---|--|---|
| <br><b>TUN'R</b><br><b>441932*</b> | <br><b>TUN'R</b><br><b>468120*</b> | <br><b>TUN'R</b><br><b>464991*</b> | <br><b>TUN'R</b><br><b>462156*</b> |
| F1 Ø8mm blanc (x1)<br>réversible  | F1 Ø8mm bleu métal (x1)<br>réversible   | F1 Ø8mm bleu (x1)<br>réversible  | F1 Ø8mm carbone blanc (x1)<br>réversible  |















|   |   |  |   |
|---|---|--|---|
| <br><b>TUN'R</b><br><b>462157*</b> | <br><b>TUN'R</b><br><b>269926*</b> | <br><b>TUN'R</b><br><b>464992*</b> | <br><b>TUN'R</b><br><b>371514*</b> |
| F1 Ø8mm carbone mat (x1)<br>réversible  | F1 Ø8mm carbone (x1) +<br>adaptateur Ø8mm<br>réversible   | F1 Ø8mm carbone rouge (x1)<br>réversible   | F1 Ø8mm chrome (x1)<br>réversible   |

\*Produits destinés à des concours tuning, usage interdit sur la voie publique.

## RÉTROVISEUR / WING MIRROR



## RÉTROVISEURS

|   |   |  |   |
|---|---|--|---|
| <br><b>TUN'R</b><br><b>465591*</b>   | <br><b>TUN'R</b><br><b>480412*</b>   | <br><b>TUN'R</b><br><b>465590*</b>   | <br><b>TUN'R</b><br><b>466809*</b>   |
| F1 Ø8mm jaune (x1)<br>réversible  | F1 Ø8mm noir mat (x1)<br>réversible   | F1 Ø8mm rouge scuderia (x1)<br>réversible  | F1 Ø10mm carbone (x1)<br>réversible   |
| <br><b>TUN'R</b><br><b>6923*</b>     | <br><b>TUN'R</b><br><b>297667*</b>   | <br><b>TUN'R</b><br><b>387778*</b>   | <br><b>TUN'R</b><br><b>461642*</b>   |
| F1 Ø8mm carbone (x1)<br>gauche  | F1 Ø10mm carbone (x1)<br>gauche   | F1 Ø10mm carbone (x1)<br>pas à gauche<br>réversible  | F1 italien Ø8mm carbone<br>gauche   |
| <br><b>TUN'R</b><br><b>387782*</b> | <br><b>Vicma</b><br><b>472124*</b> | <br><b>Vicma</b><br><b>468869*</b> | <br><b>Vicma</b><br><b>6924*</b>   |
| F1 italien Ø10mm carbone (x1)<br>gauche   | F1 Ø8mm carbone mat (x1)<br>droit   | F1 Ø8mm carbone mat (x1)<br>gauche   | F1 Ø8mm carbone brillant (x1)<br>droit  |
| <br><b>Vicma</b><br><b>449787*</b> | <br><b>TEKNIX</b><br><b>440150</b> | <br><b>TUN'R</b><br><b>476268*</b> | <br><b>TUN'R</b><br><b>477292*</b> |
| F1 Ø8mm carbone (x1)<br>gauche  | universel D8x90mm<br>pas droite noir<br>gauche  | GP1 Ø8mm alu mat (x1)<br>gauche  | GP1 Ø8mm blanc mat (x1)<br>gauche   |

\*Produits destinés à des concours tuning, usage interdit sur la voie publique.



## RÉTROVISEURS



TUN'R

479850\*

GP1 Ø8mm blanc vernis (x1)  
droit

TUN'R

477293\*

GP1 Ø8mm blanc verni (x1)  
gauche

TUN'R

479852\*

GP1 Ø8mm carbone verni (x1)  
droit

TUN'R

477294\*

GP1 Ø8mm carbone verni (x1)  
gauche

TUN'R

479851\*

GP1 Ø8mm noir mat (x1)  
droit

TUN'R

476267\*

GP1 Ø8mm noir mat (x1)  
gauche

TUN'R

479853\*

GP1 Ø8mm noir vernis (x1)  
droit

TUN'R

477295\*

GP1 Ø8mm noir vernis (x1)  
gauche

TUN'R

485683\*

FORMULA Ø8mm chrome/  
carbone (x1)  
droit

TUN'R

480665\*

FORMULA Ø8mm  
chrome/carbone (x1)  
gauche

TUN'R

480664\*

FORMULA Ø8mm carbone mat/  
chrome (x1)  
gauche

TUN'R

480666\*

FORMULA Ø8mm noir/blanc (x1)  
gauche

TUN'R

473318\*

MP318 carbone Ø8mm  
paire

TUN'R

491360\*

D-ONE blanc Ø8mm (x1)  
droit

TUN'R

491356\*

D-ONE Ø8mm blanc (x1)  
gauche

TUN'R

491362\*











D-ONE chrome Ø8mm (x1)  
droit

\*Produits destinés à des concours tuning, usage interdit sur la voie publique.

## RÉTROVISEUR / WING MIRROR





## RÉTROVISEURS

|  |  |  |   |
|--|--|--|---|
|  <p><b>491357*</b></p> <p>D-ONE Ø8mm chrome (x1)<br/>gauche</p>   |  <p><b>491359*</b></p> <p>D-ONE Ø8mm noir (x1)<br/>droit</p>                        |  <p><b>491355*</b></p> <p>D-ONE Ø8mm noir (x1)<br/>gauche</p>      |  <p><b>479523*</b></p> <p>F1 PRO Ø8mm blanc<br/>droit</p>                |
|  <p><b>479123*</b></p> <p>F1 PRO Ø8mm blanc<br/>gauche</p>        |  <p><b>479524*</b></p> <p>F1 PRO Ø8mm noir<br/>droit</p>                            |  <p><b>478749*</b></p> <p>F1 PRO Ø8mm noir<br/>gauche</p>          |  <p><b>479117*</b></p> <p>TT Ø8mm noir/blanc<br/>gauche</p>              |
|  <p><b>479118*</b></p> <p>TT Ø8mm noir/noir<br/>gauche</p>      |  <p><b>493074*</b></p> <p>Ø8mm à collier rond acier<br/>chromé<br/>réversible</p> |  <p><b>494551*</b></p> <p>F1 Ø10mm blanc (x1)<br/>réversible</p> |  <p><b>494553*</b></p> <p>F1 Ø10mm carbone mat (x1)<br/>réversible</p> |
|  <p><b>494554*</b></p> <p>F1 Ø10mm noir (x1)<br/>réversible</p> |  <p><b>494552*</b></p> <p>F1 Ø10mm rouge (x1)<br/>réversible</p>                  |  <p><b>496923*</b></p> <p>F1 Ø8mm blanc (x1)<br/>réversible</p>  |  <p><b>496606*</b></p> <p>F1 Ø8mm bleu RUBBER (x1)<br/>réversible</p>  |

\*Produits destinés à des concours tuning, usage interdit sur la voie publique.



## RÉTROVISEURS

|  |  |  |   |
|--|--|--|---|
|  <p><b>496607*</b></p> <p>F1 Ø8mm jaune fluo RUBBER (x1)<br/>réversible</p> |  <p><b>496611*</b></p> <p>F1 Ø8mm noir RUBBER (x1)<br/>réversible</p>   |  <p><b>496610*</b></p> <p>F1 Ø8mm orange fluo RUBBER (x1)<br/>réversible</p> |  <p><b>496608*</b></p> <p>F1 Ø8mm rouge RUBBER (x1)<br/>réversible</p>   |
|  <p><b>496609*</b></p> <p>F1 Ø8mm vert fluo RUBBER (x1)<br/>réversible</p>  |  <p><b>494568*</b></p> <p>GP1 Ø10mm blanc verni (x1)<br/>droit</p>      |  <p><b>494567*</b></p> <p>GP1 Ø10mm blanc verni (x1)<br/>gauche</p>          |   |
|  <p><b>494574*</b></p> <p>GP1 Ø10mm carbone verni (x1)<br/>droit</p>      |  <p><b>494573*</b></p> <p>GP1 Ø10mm carbone verni (x1)<br/>gauche</p> |  <p><b>494572*</b></p> <p>GP1 Ø10mm noir mat verni (x1)<br/>droit</p>      |  <p><b>494571*</b></p> <p>GP1 Ø10mm noir mat verni (x1)<br/>gauche</p> |
|  <p><b>494570*</b></p> <p>GP1 Ø10mm noir verni (x1)<br/>droit</p>         |  <p><b>494569*</b></p> <p>GP1 Ø10mm noir verni (x1)<br/>gauche</p>    |  <p><b>494576*</b></p> <p>GP1 Ø8mm rouge verni (x1)<br/>droit</p>          |  <p><b>494575*</b></p> <p>GP1 Ø8mm rouge verni (x1)<br/>gauche</p>     |

\*Produits destinés à des concours tuning, usage interdit sur la voie publique.

# RÉTROVISEUR / WING MIRROR

## INFO + :

**Pas à droite** : visser dans le sens des aiguilles d'une montre  
**Pas à gauche** : visser dans le sens des aiguilles d'une montre

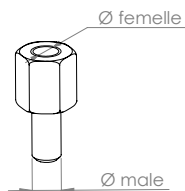

### ADAPTATEUR

|        | Ø femelle (mm) | Pas femelle | Ø mâle (mm) | Pas mâle |
|--------|----------------|-------------|-------------|----------|
| 332401 | 8              | droit       | 8           | gauche   |
| 387376 | 8              | droit       | 10          | droit    |
| 479316 | 8              | gauche      | 8           | droit    |
| 484313 | 8              | gauche      | 10          | droit    |
| 387361 | 10             | droit       | 8           | droit    |
| 387357 | 10             | droit       | 10          | gauche   |



### COLLIER ALU

|        | Filetage Ø (mm) | Pas   | Couleur |
|--------|-----------------|-------|---------|
| 473051 | 8               | droit | noir    |
| 466728 | 8               | droit | argent  |
| 466729 | 8               | droit | rouge   |
| 466727 | 8               | droit | bleu    |
| 495616 | 8               | droit | titane  |
| 491352 | 10              | droit | noir    |
| 491350 | 10              | droit | argent  |
| 491353 | 10              | droit | rouge   |
| 491351 | 10              | droit | bleu    |



### COLLIER

|        | Filetage Ø (mm) | Pas    | Couleur |
|--------|-----------------|--------|---------|
| 451784 | 8               | droit  | chrome  |
| 497585 | 8               | droit  | noir    |
| 497583 | 8               | gauche | chrome  |
| 497584 | 8               | gauche | noir    |
| 497581 | 10              | droit  | chrome  |
| 497587 | 10              | droit  | noir    |
| 497582 | 10              | gauche | chrome  |
| 497586 | 10              | gauche | noir    |



### DEMI COLLIER SUR MÂTRE CYLINDRE (X2)

482123      filetage Ø8mm pas à droite





buzzelli



**198024**

BOOSTER SPIRIT | BOOSTER 2004-> |  
NG->1998 | ROCKET

chrome



**212367**

BOOSTER ->2003 | BOOSTER 2004-> |  
NG->1998 | ROCKET

noir



**482313**

KISBEE

noir



**475524**

NITRO | AEROX ->2013

chrome



**219418**

NITRO | AEROX ->2013

noir



**484449**

NITRO | AEROX 2013 ->

noir



**477725**

OVETTO | NEOS 2007->

noir



**217984**

OVETTO | NEOS ->2007

noir



**461565**

LUDIX roue 10"

noir



**2483**

LUDIX roue 12"

noir



**461566**

LUDIX roue 14"

noir



**484623**

SPEEDFIGHT 3 et 4

noir



**295698**

SPEEDFIGHT | VIVACITY 1997->2008

noir



**484304**

TYPHOON 2011-> | SR50 MOTARD 2011 -> |  
VARIANT 2011->

noir



**296130**

STUNT | SLIDER

noir





**buzzetti**



**327334**

TREKKER | SQUAB | TKR  
noir



**3384**

ZIP | ZIP FAST RIDER  
noir



**483717**

FLY 2000-> | NRG 2000-> | RUNNER NOIR  
noir



**487575**

LIBERTY 50 2 temps et 4 temps  
noir



**486854**

RUNNER | NRG 2005 -> | POWER DD  
noir



**475813**

MACH G | JOG R  
noir



**265954**

SR50 | RALLY 1997-1999  
noir



**455241**

SR50 DITECH 2003-> moteur Piaggio  
noir



**440201**

DNA 2001->  
noir



**461567**

HONDA ZOOMER  
noir



**458156**

JET FORCE PEUGEOT  
noir



**219437**

VESPA ET2 et ET4 | VESPA LX  
noir

**buzzetti**

## RESSORT POUR BÉQUILLE LATÉRALE BUZZETTI

**450508** longueur 85mm Ø12x1.5mm

**450509** longueur 93mm Ø12x1.8mm



450508



450509



## BÉQUILLE LATÉRALE

|        |                            |        |
|--------|----------------------------|--------|
| 210478 | BOOSTER ROCKET   NG   NEXT | chrome |
| 2490   | BOOSTER SPIRIT   BW'S      | chrome |
| 497466 | KISBEE                     | noir   |
| 482612 | NITRO   AEROX ->2013       | chrome |
| 482669 | LUDIX roue 10" et 12"      | noir   |
| 3385   | TYPHOON   STALKER   NRG    | chrome |
| 482613 | STUNT   SLIDER             | chrome |
| 280483 | TREKKER   TKR   SQUAB      | chrome |



## BÉQUILLE CENTRALE NOIRE

|        |  |
|--------|--|
| 461569 | BOOSTER   BW'S 2004->   SPIRIT ->2003   NG   ROCKET                |
| 449951 | NITRO   AEROX ->2013   SR50   OVETTO   NEOS 2007-> 2 temps         |
| 486855 | NITRO   AEROX 2013 -> 2 temps                                      |
| 449952 | OVETTO   NEOS 50   100   MACH G   JOG R ->2007   F12   F15         |
| 487324 | NEOS   OVETTO 4 temps  |
| 478755 | LUDIX roue 10"   |
| 478756 | LUDIX roue 12" à 14"   SPEEDFIGHT 3 et 4                           |
| 449954 | SPEEDFIGHT   ELYSEO   VIVACITY   TREKKER   TKR                     |
| 487323 | SPEEDFIGHT 3   VIVACITY 3 4 temps                                  |
| 480235 | ZIP   ET2 2 temps, avec axe et ressort                             |
| 483446 | LIBERTY 50 4temps   125   200                                      |
| 480236 | CPI roue 12"   KEEWAY   BETA ARK   SR50 RALLY, avec axe et ressort |
| 477723 | KYMCO AGILITY 50 12" 4 temps                                       |
| 269448 | NRG   RUNNER   STALKER   TYPHOON   SR50                            |
| 372267 | STUNT   SLIDER   |
| 483443 | VESPA ET2   ET4   LX50   LX125   ZIP 50 4 temps                    |



## RESSORT POUR BÉQUILLE CENTRALE

|        |                                       |
|--------|---------------------------------------|
| 450510 | MBK   PEUGEOT   BETA   CPI   BUZZETTI |
|--------|---------------------------------------|



## BÉQUILLE CENTRALE NOIRE

|        |  |
|--------|--|
| 482489 | BOOSTER 2004->   SPIRIT ->2003   NG   ROCKET   |
| 482490 | NITRO   AEROX ->2013                           |
| 482492 | OVETTO   NEOS 50   100   MACH G   JOG R ->2007 |
| 482491 | STUNT   SLIDER                                 |





**TEKNIX**



**478514**

DERBI SENDA DRD RACING R 50  
longueur axe-extrémité 35mm



**478513**

DERBI SENDA R 2000-> longueur  
axe-extrémité 35mm



**478512**

DERBI SENDA R ->1999 longueur  
axe-extrémité 35mm



**478511**

DERBI SENDA longueur  
axe-extrémité 31mm



**478515**

RIEJU RR 50 longueur  
axe-extrémité 31mm



**490326**

RIEJU 50 MRT | MARATHON |  
TANGO avec axe et plaquette  
longueur axe-extrémité 35mm



**478516**

X LIMIT 2004-> | DT50 R 2004->  
longueur axe-extrémité 41mm



**497071**

50 TZR | XPOWER 2004->



**497072**

RIEJU SMX | RRX | MRX



**497073**

RIEJU 50 | 125 RS2 | NKD



**497074**

RIEJU 50 | 125 RS3 | NKD



**497075**

APRILIA 50/125 | RS4 | DERBI 50 |  
125 GPR 2010-> |  
TUONO 2017->



**497076**

APRILIA 50 RS 1999->2005



**497077**

APRILIA 50 RS 2006->2010 |  
DERBI GPR NUDE |  
RACING 2004->2010



**497078**

PEUGEOT 50 XR6 | MH RX50



**497079**

PEUGEOT 50 XR7 | NK7 | MH  
RX50 R



**497309**

XPS



**492319**

SHERCO 50 SM-R | SE-R



**492320**

BETA RR 50

Sélection  
**CGN****BÉQUILLE CENTRALE NOIRE**

481757 103 MVL | SP hauteur 265mm

Sélection  
**CGN**

481758 MBK 51

Sélection  
**CGN**

3389 CIAO PX

buzzell



481757

481758

3389

Sélection  
**CGN****AXE POUR BÉQUILLE CENTRALE**

4022 MBK

3391 CIAO PX à clips

3392 CIAO PX

715 103



4022

3391

3392

715

**BÉQUILLE LATÉRALE**

2473 tous modèles cyclo bras ovale

longue

lisse

chrome

**TUN'R**

2474 tous modèles cyclo bras ovale

courte

lisse

chrome

**TUN'R**

2478 tous modèles cyclo bras carré droit et gauche

courte

lisse

chrome

**TUN'R**

2470 tous modèles cyclo bras ovale

longue

torsade

chrome

**TUN'R**

2476 103 SPX | RCX

courte

lisse

torsade

**TUN'R**

167485 103 SP

courte

lisse

chrome

**TUN'R**

168037 103 SP

courte

torsade

chrome

**TUN'R**

3388 CIAO PX

lisse

chrome

**TUN'R**

440685 FOX | FXR

noir

buzzell

Sélection  
**CGN****SILENTBLOC****SILENTBLOC BRAS OSCILLANT (X1)**

497092 PEUGEOT XR6 | XPS | XP7 14x34x45x40mm



## REPOSE-PIEDS/PÉDALE / FOOT REST

**DOPPLER****REPOSE-PIEDS AVANT**

|               |      |                  |                  |
|---------------|------|------------------|------------------|
| <b>458161</b> | bleu | fourche axe 10mm | longueur 212.5mm |
|---------------|------|------------------|------------------|

**TUN'R****REPOSE-PIEDS PASSAGER**

|               |                              |        |                  |
|---------------|------------------------------|--------|------------------|
| <b>458473</b> | BOOSTER SPIRIT   BW'S 2004-> | bleu   | longueur 212.5mm |
| <b>458472</b> | BOOSTER SPIRIT   BW'S 2004-> | argent | longueur 212.5mm |



458473



458472

**TUN'R****MARCHE-PIEDS ALU POLI**

Alu poli

|               |                                 |          |
|---------------|---------------------------------|----------|
| <b>467421</b> | BOOSTER   BW'S 2004->           | 2 pièces |
| <b>467420</b> | NITRO   AEROX->2013             | 2 pièces |
| <b>488131</b> | OVETTO   NEO'S->2008            | 4 pièces |
| <b>467419</b> | LUDIX 2 pièces                  | 2 pièces |
| <b>489985</b> | TYPHOON->2011   STROM   NRG MC1 | 2 pièces |
| <b>468249</b> | TMAX 500 argent                 | 2 pièces |



467421

Alu bleu

|               |                              |          |
|---------------|------------------------------|----------|
| <b>451748</b> | BOOSTER SPIRIT   BW'S ->2003 | 2 pièces |
|---------------|------------------------------|----------|



451748

**TUN'R**
**REPOSE-PIEDS PILOTE ALU (PAIRE)**

|               |             |        |
|---------------|-------------|--------|
| <b>482617</b> | DERBI SENDA | argent |
| <b>482618</b> | DERBI SENDA | rouge  |



482617

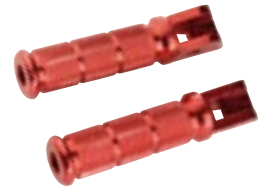

482618

**TUN'R**
**REPOSE-PIEDS PASSAGER UNIVERSEL ALU (PAIRE)**

|               |        |
|---------------|--------|
| <b>482619</b> | argent |
| <b>482620</b> | rouge  |



482619

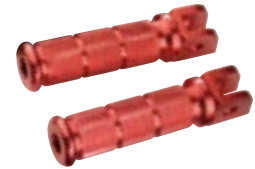

482620

**TUN'R**
**PÉDALE DE FREIN**

|               |               |              |
|---------------|---------------|--------------|
| <b>467340</b> | DERBI SENDA   | lighty bleu  |
| <b>466723</b> | X-LIMIT   AM6 | lighty bleu  |
| <b>494232</b> | X-LIMIT   AM6 | lighty rouge |



467340



466723



494232

**TUN'R**
**ADAPTATEUR REPOSE-PIEDS ALU**

|               |             |
|---------------|-------------|
| <b>440833</b> | RS50 1999-> |
| <b>450279</b> | XP6         |



440833



450279

## REPOSE-PIEDS/PÉDALE / FOOT REST

**TUN'R**
**REPOSE-PIEDS PILOTE ALU MOLETÉ (PAIRE)**

|        |        |
|--------|--------|
| 276575 | argent |
| 292498 | bleu   |
| 276567 | noir   |
| 276556 | or     |
| 292483 | rouge  |



276575



292498



276567



276556



292483

**TUN'R**
**REPOSE-PIEDS PILOTE (PAIRE)**

|        |           |        |
|--------|-----------|--------|
| 122336 | alu       |        |
| 2867   | plat      | noir   |
| 122279 | U lisse   | chrome |
| 2872   | U torsadé | chrome |



122336



2867



122279



2872

**TUN'R**
**REPOSE-PIEDS ARRIÈRE (PAIRE)**

|      |            |      |
|------|------------|------|
| 2870 | bras carré | noir |
| 2869 | bras oval  | noir |
| 2876 | dallas     | noir |



2870



2869



2876

**TUN'R**
**PÉDALE LANCEUR (PAIRE)**

|      |              |
|------|--------------|
| 2885 | 103/51 acier |
|------|--------------|





### PÉDALE (PAIRE)

707

103



### PIÈCES DE PÉDALIERS

|        |                           |                                    |
|--------|---------------------------|------------------------------------|
| 482641 | axe pédalier/poulie lisse | 51 PASSION   MAGNUM   SWING   ROCK |
| 497049 | axe pédalier/poulie lisse | 103 MVL   SP   VOGUE   CHRONO      |
| 702    | axe pédalier/poulie       | 103 MVL   SP   VOGUE   CHRONO      |
| 4272   | axe pédalier/poulie       | 41/51                              |
| 4277   | bague pédalier            | 51                                 |
| 489595 | bague pédalier            | 103   MVL   VOGUE   SP   CHRONO    |



482641



497049



702



4272



4277



489595



### PIÈCES DE PÉDALIERS

|        |   |                      |              |
|--------|---|----------------------|--------------|
| 4278   | circlips, clips pédalier                          | 51                   |              |
| 4269   | rondelle poulie avec clips, épaisseur 0.5-0.7-1.2 |                      | Ø16x27-16x32 |
| 481375 | rondelle poulie plastique                         | 103 SP   MVL   VOGUE | Ø16x32       |
| 491049 | rondelle poulie plastique                         | 103 SP   MVL   VOGUE | Ø16x28       |



4278



4269



481375



491049



# KICK DE DÉMARRAGE / KICK START



**DOPPLER**

**BOOSTER | BW'S 1999-> | NITRO | AEROX | LUDIX | SPEEDFIGHT**

**CYCLE**



**497418**  
noir/bleu



**497419**  
noir/argent



**497416**  
noir/rouge



**497417**  
noir/or



**475262**  
blanc



**475261**  
noir

**TUNER**



**462129**  
alu blanc



**440081**  
alu bleu



**462127**  
alu carbone brillant



**440080**  
alu chrome



**440084**  
alu noir



**461039**  
alu rouge



**464954**  
alu carbone brillant



**461825**  
alu bleu



**461837**  
alu noir mat



**464989**  
alu rouge



**473026**  
acier



**482841**  
news alu



**466721**  
lighty alu titane



**466712**  
orange



**466713**  
noir



**467802**  
camouflage

**TUN'R BOOSTER, BW'S ->1998**

**4321**

acier chromé

**TUN'R PEUGEOT**

**381765**

BUXY | ZENIT | SPEEDAKE acier carbone

**451355**

SPEEDFIGHT alu chromé

**451356**

SPEEDFIGHT alu carbone brillant

**TEKNIX KICK DE DÉMARRAGE**

**381731**

 BOOSTER | BW'S ->1998 acier  
noir

**483835**

 BOOSTER | STUNT | NITRO |  
OVETTO acier

**265170**

 TREKKER | TKR | VIVACITY |  
SPEEDFIGHT | BUXY | ZENITH  
acier noir

**381746**

 TYPHOON | STALKER | NRG | ZIP  
| DNA | ICE | SR50 acier noir

**485935**

CPI | KEEWAY type origine

**485940**

GY6 | 139QMB | V-CLIC | SCOOTER CHINOIS type origine

**AXE DE KICK**
**322060** BOOSTER | BW'S | STUNT | SLIDER | OVETTO | NEOS

**460590** BOOSTER | BW'S | STUNT | SLIDER

**460131** SPEEDFIGHT | TREKKER | LUDIX | KISBEE | KYMCO 2

**466795** CPI | KEEWAY 50CC

**460134** NRG | RUNNER | ZIP | TYPHOON | STALKER | SR50 2005->

**466796** SCOOTER CHINOIS 50CC | 139QMB | AGILITY 4 temps



## RESSORT DE KICK

|               |  |  |
|---------------|--|--|
| <b>322074</b> | BOOSTER   BW'S   STUNT   SLIDER   ROCKET   NG   NEXT |  |
| <b>487260</b> | TREKKER   VIVACITY   SPEEDFIGHT   LUDIX   KISBEE     |  |
| <b>487261</b> | TYPHOON   NRG   SR50   VESPA LX   LIBERTY   STALKER  |  |
| <b>485939</b> | GY6   139 QMB  |  |



## NOIX DE KICK

|               |   | Longueur |  |
|---------------|---|----------|--|
| <b>482290</b> | FOX   SPEEDFIGHT   TREKKER   LUDIX   VIVACITY court     | 12.5mm   |  |
| <b>490087</b> | tout modèle KYMCO 50 2 et 4 temps   PEUGEOT 50 2 temps  | 13.5mm   |  |
| <b>490088</b> | SPEEDFIGHT   VIVACITY   LUDIX long                      | 15.5mm   |  |
| <b>476737</b> | SPEEDFIGHT   TREKKER   VIVACITY   FOX   LUDIX court     | 12.5mm   |  |
| <b>479326</b> | KYMCO 50 2 et 4 temps sauf AGILITY   PEUGEOT 50 2 temps | 13.5mm   |  |
| <b>479327</b> | SPEEDFIGHT   VIVACITY   LUDIX   FOX   KISBEE   DJANGO   | 15.5mm   |  |
| <b>188376</b> | BOOSTER   BW'S   NITRO   AEROX   SR50   OVETTO          |          |  |
| <b>460591</b> | BOOSTER   BW'S   NITRO   AEROX   SR50   OVETTO          |          |  |
| <b>460136</b> | NRG   ZIP   TYPHOON   STALKER   RUNNER                  |          |  |
| <b>466800</b> | CPI   |          |  |
| <b>468851</b> | SCOOTER CHINOIS 50CC 4 temps   V CLIC   139QMB   GY6    |          |  |
| <b>468854</b> | SCOOTER CHINOIS 50CC   139QMB   GY6 4 temps             |          |  |
| <b>495907</b> | KYMCO 50 AGILITY 2 et 4 temps                           | 16mm     |  |



482290



490087



490088



476737



479326



479327



188376



460591



460136



466800



468851





468854



495907



## RESSORT NOIX DE KICK

|        |  |   |
|--------|--|---|
| 449957 | BOOSTER   BW'S   STUNT   SLIDER   NG   ROCKET      |  |
| 460592 | BOOSTER   BW'S   NITRO   AEROX   SR50 type origine |  |
| 467605 | SPEEDFIGHT   TREKKER   TKR   VIVACITY              |  |

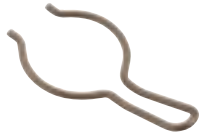

449957







460592



467605

## ROCHER DE KICK

|        |  |   |
|--------|--|---|
| 327406 | BOOSTER   BW'S   STUNT   SLIDER   ROCKET |    |
| 260034 | TYPHOON   ZIP   NRG   STROM tout modèle  |   |
| 466805 | CPI                                      |  |
| 479583 | TYPHOON   STALKER   ZIP   SR50   FLY     |  |
| 484621 | KISBEE   SYM   AGILITY   KYMC            |  |
| 494260 | FLY   LIBERTY   STALKER   TYPHOON 1999-> |  |
| 494783 | BOOSTER   NITRO   SR50 type origine      |  |



466805



494260

Sélection  
CGN

## RONDELLE AXE DE KICK

|        |  |
|--------|--|
| 483638 | BOOSTER   BW'S   S TUNT   SLIDER   NITRO   AEROX   OVETTO   NEOS |
|--------|--|

Sélection  
CGN

## CIRCLIP AXE DE KICK

|        |  |
|--------|--|
| 483500 | BOOSTER   BW'S   S TUNT   SLIDER   NITRO   AEROX   OVETTO   NEOS |
|--------|--|



# KICK DE DÉMARRAGE / KICK START

## TUN'R AM6



**376023**

acier chromé



**451365**

alu chromé



**464956**

pliable alu lighty bleu



**464957**

pliable alu lighty carbone



**464958**

pliable alu lighty rouge



**494233**

alu rouge

## TUN'R DERBI SENDA



**381867**

alu bleu



**381875**

alu carbone brillant



**462125**

alu carbone mat



**381856**

alu chromé



**440093**

alu rouge



**464959**

alu bleu



**464960**

alu carbone



**464961**

alu rouge

## TEKNIX KICK DE DÉMARRAGE



**381818**

AM6 acier noir



**381784**

DERBI SENDA acier noir



**480782**

DERBI SENDA acier chromé



**381841**

SUZUKI RMX | SMX 50 acier noir



### AXE DE KICK

**466802** DERBI SENDA

**466801** AM6



466802



466801



### KICK DE DÉMARRAGE



**4322**

MBK 51 acier chromé



**335688**

103 SPX | RCX acier noir



**335673**

103 FOX | FXR acier noir



### NOIX DE KICK

**466575** 51 MBK

**482290** FOX



466575



482290



### RESSORT DE KICK

**466574** MBK 51



# SÉLECTEUR DE VITESSE / SHIFT SELECTOR

INFO + :

Retrouvez l'axe de sélecteur **page 239.**

**TUN'R** AM6



**451482**

repliable alu bleu



**451372**

repliable alu carbone



**451371**

repliable alu chrome



**462122**

repliable alu carbone mat et bleu



**462123**

repliable alu carbone mat et chrome



**462124**

repliable alu carbone mat et rouge



**464947**

repliable alu bleu



**464949**

repliable alu carbone



**464948**

repliable alu rouge



**376042**

non repliable acier chrome

**TUN'R** RS50



**383859**

alu chrome

## SÉLECTEUR DE VITESSE / SHIFT SELECTOR

TUN'R

DERBI SENDA



383806

non repliable alu chrome



462119

repliable alu carbone mat et bleu



462120

repliable alu carbone mat et chrome



462121

repliable alu carbone mat et rouge



451375

repliable alu carbone



451373

repliable alu chrome



464950

repliable alu bleu



464951

repliable alu carbone



464952

repliable alu rouge



494231

repliable acier noir

TUN'R

DERBI GPR



494262

alu noir



494263

alu argent

TEKNIX

## SÉLECTEUR DE VITESSE

383734 AM6 non repliable acier noir

334768 DERBI SENDA non repliable acier noir



383734



334768

buzzeff

## MANGHON CAOUTCHOUC

484624 pour sélecteur universel longueur 40mm



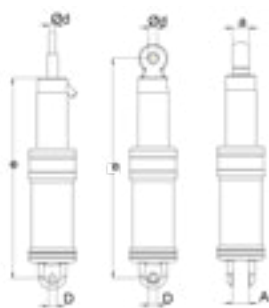

## AMORTISSEUR / SHOCK ABSORBER

**DOPPLER**
**AMORTISSEUR OLÉOPNEUMATIQUE**

|        |                                    |       | e     | a    | A      | d    | D   |
|--------|------------------------------------|-------|-------|------|--------|------|-----|
| 450670 | BOOSTER   BW'S                     | bleu  | 255mm | 20mm | 20mm   | 10mm | 8mm |
| 450671 | BUXY   TKR   SPEEDFIGHT            | bleu  | 275mm | 20mm | 20mm   | 10mm | 8mm |
| 475280 | LUDIX                              | noir  | 315mm | 20mm | 20mm   | 10mm | 8mm |
| 460657 | LUDIX                              | bleu  | 315mm | 20mm | 20mm   | 10mm | 8mm |
| 475210 | NITRO   BOOSTERLONG   CPI   KEEWAY | noir  | 270mm | 20mm | 20mm   | 10mm | 8mm |
| 475209 | NITRO   BOOSTERLONG   CPI   KEEWAY | blanc | 270mm | 20mm | 20mm   | 10mm | 8mm |
| 452084 | NITRO   BOOSTERLONG   CPI   KEEWAY | bleu  | 270mm | 20mm | 20mm   | 10mm | 8mm |
| 450673 | SR50MOTEURMINARELLI                | bleu  | 285mm | 20mm | 20mm   | 10mm | 8mm |
| 475214 | STUNT   SLIDER                     | noir  | 325mm | 20mm | 20mm   | 10mm | 8mm |
| 475213 | STUNT   SLIDER                     | blanc | 325mm | 20mm | 20mm   | 10mm | 8mm |
| 450674 | STUNT   SLIDER                     | bleu  | 325mm | 20mm | 20mm   | 10mm | 8mm |
| 475211 | TYPHOON   NRG   ZIP   STALKER      | noir  | 295mm | 20mm | 32.5mm | 8mm  | 8mm |
| 475212 | TYPHOON   NRG   ZIP   STALKER      | blanc | 295mm | 20mm | 32.5mm | 8mm  | 8mm |
| 450675 | TYPHOON   NRG   ZIP   STALKER      | bleu  | 295mm | 20mm | 32.5mm | 8mm  | 8mm |



Bleu



Noir



Blanc

**TUN'R**
**AMORTISSEUR AVANT**

|        |            |                         | e     | a    | A    | d    | D   |
|--------|------------|-------------------------|-------|------|------|------|-----|
| 467415 | SPEEDFIGHT | réglable                | 260mm | 20mm | 20mm | 10mm | 8mm |
| 482169 | VESPA LX50 | réglable dureté ressort |       |      |      |      |     |



467415

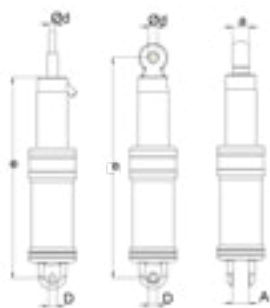

482169

**TUN'R**
**AMORTISSEUR RÉGLABLE À RESSORT**

|               |  |             | e     | a    | A      | d    | D   |
|---------------|--|-------------|-------|------|--------|------|-----|
| <b>473116</b> | tous modèles scooter                   | or, blanc   | 300mm | 20mm | 20mm   | 10mm | 8mm |
| <b>2784</b>   | BOOSTER   BW'S   NEXT   ROCKET         | chrome      | 245mm | 20mm | 20mm   | 10mm | 8mm |
| <b>188156</b> | BUXY   TREKKER   SPEEDFIGHT            | chrome      | 280mm | 20mm | 20mm   | 10mm | 8mm |
| <b>461602</b> | LUDIX                                  | rouge       | 310mm | 20mm | 20mm   | 10mm | 8mm |
| <b>451429</b> | NITRO   OVETTO   SR50                  | blanc       | 280mm | 20mm | 20mm   | 10mm | 8mm |
| <b>207700</b> | TYPHOON   NRG   ZIP   STALKER   RUNNER | chrome      | 315mm | 20mm | 32.5mm | 8mm  | 8mm |
| <b>495288</b> | tous modèles scooter                   | noir, rouge |       | 20mm | 20mm   | 10mm | 8mm |
| <b>495298</b> | PEUGEOT (sauf LUDIX)                   |             | 280mm | 20mm | 20mm   | 10mm | 8mm |



Or, blanc



Chrome



Rouge



Blanc

**TEKNIX**
**AMORTISSEUR À RESSORT**

|               |  |        | e     | a    | A      | d       | D       |
|---------------|--|--------|-------|------|--------|---------|---------|
| <b>482170</b> | VESPAET2   NRG   STALKER   LIBERT                            | noir   | 295mm | 20mm | 32.5mm | 8mm     | 8mm     |
| <b>493051</b> | APRILIA 50 SPORT CITY 2008-2011   SR MOTARD   TYPHOON 2011-> | chrome | 340mm | 28mm | 33mm   | 28mm    | 10mm    |
| <b>493052</b> | APRILIA 50 SR STREET 2003-2012   FACTORY 2005->              | chrome | 298mm | 21mm | 36.5mm | 10.25mm | 10.25mm |



Noir



Chrome

## AMORTISSEUR / SHOCK ABSORBER

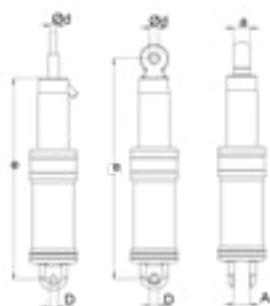
**DOPPLER**
**RÉHAUSSE AMORTISSEUR**

|               |  |        |
|---------------|--|--------|
| <b>455240</b> | BOOSTER BW'S 2004->   NITRO   AEROX            | titane |
| <b>266957</b> | TREKKER   SPEEDFIGHT   VIVACITY   BUXY   SPEED | alu    |
| <b>277878</b> | TYPHOON   NRG   STALKER   ICE   DNA   RUNNER   | alu    |



455240

266957

277878

**TUN'R**
**RÉHAUSSE AMORTISSEUR RÉGLABLE ALU**

|               |   |       |
|---------------|---|-------|
| <b>475849</b> | LUDIX   SPEEDFIGHT 3   JETFORCE                       | noir  |
| <b>473456</b> | PIAGGIOTYPHOON   ZIP   NRG   STALKER                  | blanc |
| <b>473036</b> | PIAGGIOTYPHOON   ZIP   NRG   STALKER                  | bleu  |
| <b>478712</b> | BOOSTER   BW'S 2004->   NITRO   AEROX   OVETTO   NEOS | noir  |
| <b>478713</b> | BOOSTER   BW'S 2004->   NITRO   AEROX   OVETTO   NEOS | alu   |
| <b>478715</b> | BOOSTER   BW'S 2004->   NITRO   AEROX   OVETTO   NEOS | blanc |



475849

473456

473036

478712

478713

478715



**INFO + :**

Gonflez entre 18 et 21 bars en fonction de la fermeté souhaitée

**DOPPLER**
**AMORTISSEUR OLÉOPNEUMATIQUE**

|               | e  | a    | A     | d      | D      |      |
|---------------|--|------|-------|--------|--------|------|
| <b>461088</b> | DERBI SENDA 2000->                           | bleu | 285mm | 24mm   | 30mm   | 12mm |
| <b>461084</b> | GPR 50 2000->2005                            | bleu | 260mm | 22mm   | 35mm   | 10mm |
| <b>468763</b> | GPR NUDE   RACING 2004->2010   RS 2006->2010 | bleu | 290mm | 24.5mm | 24.5mm | 10mm |
| <b>461085</b> | MRX   SMX   RIEJU                            | bleu | 300mm | 26mm   | 26mm   | 10mm |
| <b>461089</b> | X-LIMIT   DT50 2003->                        | bleu | 310mm | 34.5mm | 35.5mm | 10mm |
| <b>461090</b> | X-POWER   TZR ->2004                         | bleu | 265mm | 35mm   | 50mm   | 12mm |

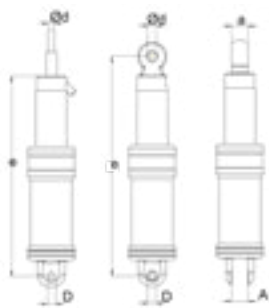

**TUN'R**
**AMORTISSEUR HYDRAULIQUE À RESSORT**

|               |                                |          | e     | a    | A    | d    | D    |
|---------------|--------------------------------|----------|-------|------|------|------|------|
| <b>484148</b> | SENDA 2000-> ENTRAXE 300       |          | 300mm | 24mm | 30mm | 12mm | 12mm |
| <b>482166</b> | SENDA 1999-> REGLABLE DURETE   | réglable | 300mm | 24mm | 30mm | 12mm | 12mm |
| <b>482165</b> | GPR NUDE 2005->   RACING 04->1 | réglable | 280mm | 24mm | 24mm | 10mm | 10mm |
| <b>476860</b> | RIEJU MRX   SMX REGLABLE RESSO | réglable | 305mm | 26mm | 26mm | 10mm | 10mm |
| <b>462113</b> | X-LIMIT   DT50 ->2003 REGLABLE | réglable | 295mm | 35mm | 35mm | 10mm | 10mm |
| <b>482164</b> | XP6   XP7 REGLABLE DURETE RESS | réglable | 300mm | 24mm | 24mm | 10mm | 10mm |
| <b>482167</b> | X POWER   TZR 50 2004->REGLABL | réglable | 260mm | 28mm | 40mm | 12mm | 10mm |
| <b>482168</b> | XR6 REGLABLE DURETE ENTRAXE    | réglable | 267mm | 35mm | 46mm | 10mm | 10mm |



484148



462113



482166



482164



482165



482167



476860



482168

**TUN'R**
**RÉHAUSSE AMORTISSEUR ALU**

|               |             |       |
|---------------|-------------|-------|
| <b>483395</b> | DERBI SENDA | noir  |
| <b>484673</b> | DERBI SENDA | blanc |
| <b>468814</b> | DERBI SENDA | alu   |
| <b>461880</b> | DERBI SENDA | bleu  |
| <b>468187</b> | DERBI SENDA | rouge |
| <b>484674</b> | DERBI SENDA | vert  |



483395



484673



468814



461880



468187



484674

## AMORTISSEUR / SHOCK ABSORBER

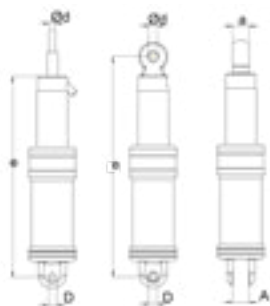

Sélection  
**CGN**

## SILENTBLOC BRAS OSCILLANT

497092 XR6 | XPS | XP7 14x34x45x40mm



**TUN'R**

## AMORTISSEUR (PAIRE)

|        |          |                               |       |
|--------|----------|-------------------------------|-------|
| 2775   | 103   51 | chrome, réglable              | 320mm |
| 2776   | 103   51 | chrome, réglable              | 360mm |
| 122704 | 103   51 | chrome, réglable, hydraulique | 320mm |



2775



2776



122704

Sélection  
**CGN**

## AMORTISSEUR (PAIRE)

|        |                  |              |       |
|--------|------------------|--------------|-------|
| 496078 | 103 type origine | chrome lisse | 320mm |
|--------|------------------|--------------|-------|



Sélection  
**CGN**

## POMPE POUR AMORTISSEUR ET FOURCHE À SUSPENSION

|        |                        |        |
|--------|------------------------|--------|
| 440656 | avec manomètre 20 bars | argent |
|--------|------------------------|--------|



**DOPPLER**
**FOURCHE**

|   |   |                | Ø Disque |
|---|---|----------------|----------|
| <b>461082</b>                                       | LUDIX avec garbe boue carbone                         | carbone   gris | 155mm    |
| <b>461042</b>                                       | NITRO   AEROX 1997->2001   ROCKET fixation garde boue | carbone   gris | 190mm    |
| <b>461043</b>                                       | NITRO   AEROX 2002->                                  | argent         | 190mm    |
| <b>467603</b>                                       | SONIC APRILIA   | noir   blanc   | 155mm    |
| <b>Fixation garde-boue Rocket sur fourche Nitro</b> |   |                |          |
| <b>483959</b>                                       | NITRO   AEROX   |                |          |



461082



483959

**DOPPLER**
**ENTRETOISE ÉTRIER DE FREIN POUR FOURCHE DOPPLER**

|               |                       |     |
|---------------|-----------------------|-----|
| <b>450438</b> | BOOSTER ROAD   SPIRIT | 4mm |
|---------------|-----------------------|-----|

**DOPPLER**
**JOINT SPI (X2)**

|               |   |
|---------------|---|
| <b>450433</b> | tout modèles livré avec cache poussière |
|---------------|---|



**TEKNIX**
**FOURCHE TYPE ORIGINE**

|               |   |
|---------------|---|
| <b>482219</b> | BOOSTER   BW'S 1995->2003 disque 180mm    |
| <b>482210</b> | BOOSTER   BW'S 2004->                     |
| <b>482217</b> | LUDIX roue 10" disque 155mm               |
| <b>482216</b> | LUDIX ONE roue 10"                        |
| <b>491140</b> | LUDIX roue 12"                            |
| <b>491141</b> | LUDIX roue 14"                            |
| <b>482325</b> | NITRO   AEROX 2003->                      |
| <b>482211</b> | NITRO   AEROX ->2003                      |
| <b>482214</b> | STUNT   SLIDER                            |
| <b>482213</b> | TREKKER   TKR   METAL X   VIVACITY 1 et 2 |
| <b>482212</b> | NRG ->2005   TYPHOON ->2011               |
| <b>482215</b> | ZIP 2009->                                |
| <b>489393</b> | KISBEE 2 et 4 temps                       |

**buzzell**
**TÉ DE FOURCHE**

|               |                            | Ø de tube | Entraxe | Longueur du pivot |
|---------------|----------------------------|-----------|---------|-------------------|
| <b>479323</b> | AGILITY KYMCO 12" 50   125 | 30mm      | 202mm   | 393mm             |
| <b>461575</b> | BOOSTER   BW'S 2004->      | 30mm      | 190mm   | 348mm             |
| <b>383901</b> | OVETTO   NEOS              | 26mm      | 205mm   | 375mm             |
| <b>494526</b> | MACH G   JOG R             | 26mm      | 180mm   | 355mm             |

**453**



## TÉ DE FOURCHE

|        |  |
|--------|--|
| 482485 | BOOSTER   BW'S 2004->                                |
| 482486 | NEXT   ROCKET 1998->   NG   NITRO   AEROX 1999->2002 |
| 482487 | NITRO   AEROX 2002 ->   MALAGUTI F12 2007->          |
| 482488 | OVETTO   NEOS  |
| 482326 | STUNT   SLIDER                                       |
| 485919 | SCOOTER CHINOIS   V-CLIC                             |



### INFO + :

Retrouvez l'huile de fourche **page 615**.



## JEU DE DIRECTION

|        |  |
|--------|--|
| 449959 | NITRO   AEROX   STUNT   SLIDER 2002->                          |
| 449960 | TYPHOON   NRG   RUNNER   STALKER   ZIP   SR50 MOTARD   VARIANT |
| 284125 | BOOSTER   BW'S 2004->   JOG R   OVETTO   NEOS 2004->           |
| 491448 | 50   125 SYM FIDDLE 2   SYMPHONY   PEUGEOT TWEET               |

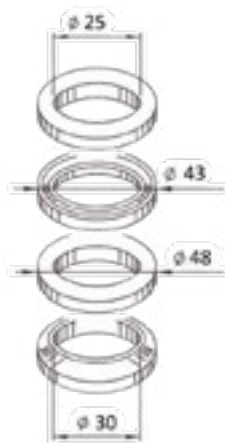

449959



449960

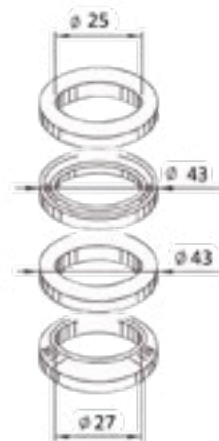

284125

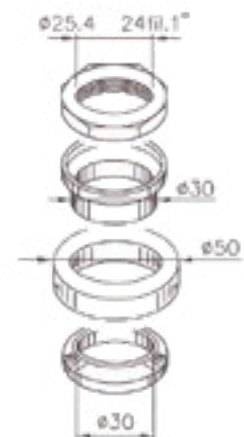

491448





## JEU DE DIRECTION

|               |  |
|---------------|--|
| <b>478427</b> | BOOSTER   BW'S 2004->   OVETTO   NEOS 2004->                             |
| <b>284117</b> | BOOSTER   BW'S ->2004   NITRO   AEROX ->2002   OVETTO   NEOS ->2004   NG |
| <b>478428</b> | NITRO   AEROX 2002->   STUNT   SLIDER 2002->                             |
| <b>482611</b> | KEEWAY   CPI 50CC  |
| <b>483057</b> | KISBEE   SPEEDFIGHT 3 et 4   VIVACITY3   DJANGO                          |
| <b>440692</b> | SPEEDFIGHT   TREKKER   VIVACITY   LUDIX   JET FORCE   ELYSTAR            |
| <b>482790</b> | SYM MIO   JET   DD   |
| <b>483056</b> | V.CLIC   SCOOT CHINOIS   |
| <b>493099</b> | PIAGGIO 50   125 FLY   ZIP   LIBERTY   NRG                               |

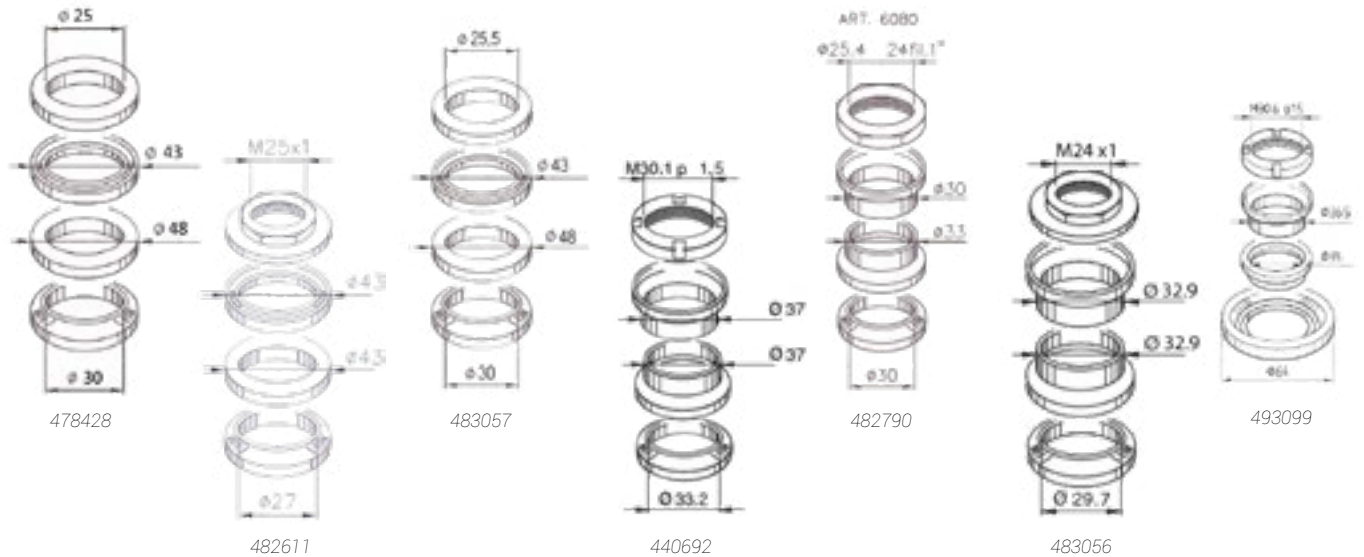
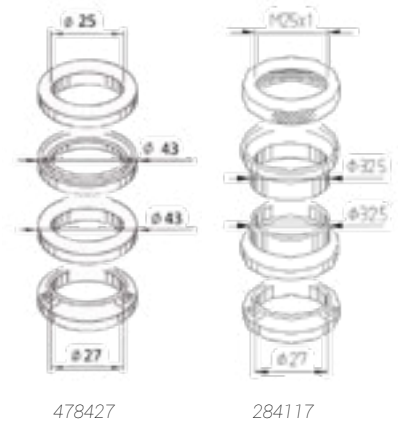

## JOINT SPI FOURCHE (X2)

|               |  | Ø intérieur | Ø extérieur | hauteur |
|---------------|--|-------------|-------------|---------|
| <b>480605</b> | BOOSTER   NEXT   NITRO   MAGNUM PAIOLI   | 29.8mm      | 47.7mm      | 7.7mm   |
| <b>480600</b> | BOOSTER   BW'S   NITRO   AEROX           | 30mm        | 40.5mm      | 10.5mm  |
| <b>485239</b> | BOOSTER ->2004                           | 30mm        | 40.5mm      | 10.5mm  |
| <b>480598</b> | OVETTO   NEOS   MACH G   JOG R   ADDRESS | 26mm        | 37mm        | 10.5mm  |
| <b>480606</b> | TREKKER   SQUAB   TYPHOON   NRG SHOWA    | 26mm        | 35.5mm      | 7.7mm   |
| <b>480621</b> | STALKER   RUNNER   NRG                   | 30mm        | 39/43mm     | 11.6mm  |
| <b>480607</b> | TYPHOON   STORM   ZIP                    | 30mm        | 38/42mm     | 12mm    |
| <b>480604</b> | ZIP                                      | 27.7mm      | 35mm        | 7/9mm   |
| <b>480597</b> | ZIP   FREE                               | 25.7mm      | 37mm        | 10.5mm  |
| <b>480602</b> | AGILITY 50   125   SUPER 8               | 33mm        | 46mm        | 11mm    |
| <b>480599</b> | ZIP   LIBERTY   SR50   BURGMAN           | 30mm        | 40mm        | 8/9mm   |
| <b>485880</b> | CPI   KEEWAY                             | 31mm        | 43mm        | 10.5mm  |





### TUBE DE FOURCHE

|        |                                 |
|--------|---------------------------------|
| 497439 | DT   XLIMIT   XP6   XPS   SENDA |
| 497440 | SENDA   XP6   RIEJU RR   RMX    |
| 497442 | XPOWER   TZR 2002->             |
| 492306 | SENDA   SMT   RCR   MRT   HRD   |



### JOINT SPI FOURCHE (X2)

|        |   | Ø intérieur | Ø extérieur | hauteur  |
|--------|---|-------------|-------------|----------|
| 480623 | SENDA (MARZOCCHI) EVO   GPR   RS   XR7   NK7   RS4      | 40mm        | 52mm        | 10.5mm   |
| 480622 | SENDA   MRT   SHERCO   SMT   RCR (PAIOLI)   XCITY       | 37mm        | 49mm        | 10mm     |
| 485240 | SENDA (PAIOLI)  | 36mm        | 53.7mm      | 13.7mm   |
| 485241 | SENDA   BMW   | 40mm        | 52.5mm      | 4.6/14mm |
| 480618 | RIEJU MRX 50   MXR 50   RS2   RS3   SMX   DNA           | 34.74mm     | 47mm        | 9mm      |
| 480619 | SHOWA RR50   SPIKE   XP6   SENDA   GPR   DT50   X LIMIT | 32mm        | 43mm        | 10mm     |
| 480608 | XP6   XPS   XLIMIT   DT50 R   ELYSEO   SENDA   BETA     | 36mm        | 48mm        | 11mm     |
| 480609 | TZR   MAJESTY   ELYSTAR 125 2002->   SPIKE   STUNT      | 33mm        | 45mm        | 10mm     |



### TÉ DE FOURCHE

|        |   |
|--------|---|
| 483723 | DERBI SENDA   GILERA GSM Ø passage du tube 45mm |
|--------|---|



# FOURCHE / FORK



## JEU DE DIRECTION

**493097** X-POWER | TZR 2004->

**493098** MBK X-LIMIT | YAMAHA DT50

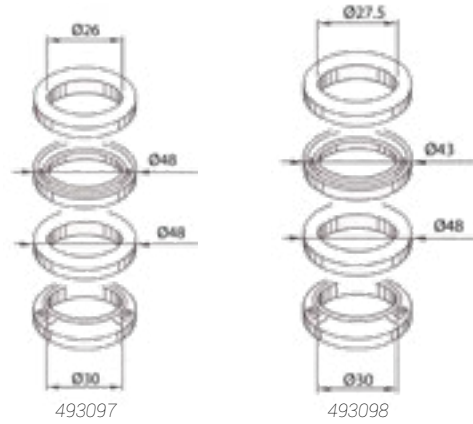

## PROTECTION DE FOURCHE (PAIRE)

**452036** carbone, livré avec collier Rilsan Ø40-55mm



## PROTECTION DE FOURCHE (PAIRE)

**2759** 103 MVL | VOGUE | CHRONO chrome

**2753** 103 SP | SPX | RCX chrome

**481764** MBK 51 SWING | MAGNUM | HARD ROCK | PASSION TELESCOP noir

**3352** CIAO PX livré sans système de balancier noir



2759



2753



## JEU DE DIRECTION

**480420** MBK 51 | 88 | DAKOTA | 41 | PHENIX

**480421** 103 | VOGUE | MVL | SP | SPX | RCX

**483643** CIAO

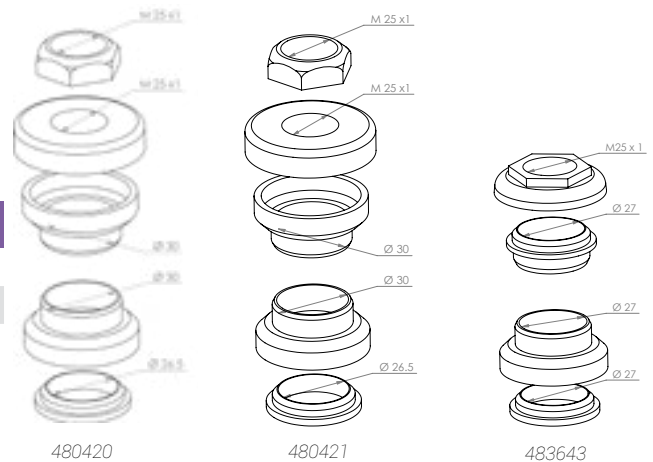

480420

480421

483643



## PIÈCES DÉTACHÉES DE FOURCHE

**3356** tampon de fourche CIAO PX

**209186** ressort et tampon CIAO PX



3356

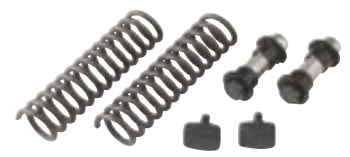

209186

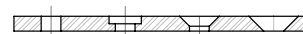

 Sélection  
**CGN**

## DISQUE UNIVERSEL SCOOTER

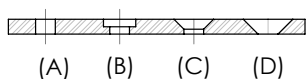

(A) (B) (C) (D)

|                       |                  | N° schéma | Référence     | Ø extérieur (mm) | Ø intérieur (mm) | Nombre de trous de fixation | Ø trou (mm) | Type de perçage |
|-----------------------|------------------|-----------|---------------|------------------|------------------|-----------------------------|-------------|-----------------|
| <b>BETA</b>           |                  |           |               |                  |                  |                             |             |                 |
| universel 50          |                  | 1         | <b>478565</b> | 190              | 58               | 3                           | 8.4         | A               |
| universel 50          |                  | 1         | <b>478565</b> | 190              | 58               | 3                           | 8.5         | B               |
| universel 50          |                  | 1         | <b>478565</b> | 190              | 58               | 3                           | 8.5         | C               |
| universel 50          |                  | 1         | <b>478565</b> | 190              | 58               | 3                           | 10.5        | B               |
| <b>MBK</b>            |                  |           |               |                  |                  |                             |             |                 |
| BOOSTER 2004->        | avant            | 2         | <b>466315</b> | 180              | 48.2             | 4                           | 10.6        | B               |
| BOOSTER NG ->1998     | avant            | 2         | <b>466315</b> | 180              | 48.2             | 4                           | 10.6        | B               |
| BOOSTER NG 1999->     | avant            | 3         | <b>466317</b> | 190              | 58.5             | 3                           | 8.7         | B               |
| BOOSTER NG 1999->     | avant            | 3         | <b>466317</b> | 190              | 58.5             | 3                           | 8.9         | D               |
| BOOSTER NG 1999->     | avant            | 3         | <b>466317</b> | 190              | 58.5             | 3                           | 10.5        | B               |
| BOOSTER SPIRIT 1999-> | avant            | 2         | <b>466315</b> | 180              | 48.2             | 4                           | 10.6        | B               |
| NITRO                 | avant et arrière | 3         | <b>466317</b> | 190              | 58.5             | 3                           | 8.7         | B               |
| NITRO                 | avant et arrière | 3         | <b>466317</b> | 190              | 58.5             | 3                           | 8.9         | D               |
| NITRO                 | avant et arrière | 3         | <b>466317</b> | 190              | 58.5             | 3                           | 10.5        | B               |
| STUNT                 | avant            | 3         | <b>466317</b> | 190              | 58.5             | 3                           | 8.7         | B               |
| STUNT                 | avant            | 3         | <b>466317</b> | 190              | 58.5             | 3                           | 8.9         | D               |
| STUNT                 | avant            | 3         | <b>466317</b> | 190              | 58.5             | 3                           | 10.5        | B               |
| universel 50/100      |                  | 1         | <b>478565</b> | 190              | 58               | 3                           | 8.4         | A               |
| universel 50/100      |                  | 1         | <b>478565</b> | 190              | 58               | 3                           | 8.5         | B               |
| universel 50/100      |                  | 1         | <b>478565</b> | 190              | 58               | 3                           | 8.5         | C               |
| universel 50/100      |                  | 1         | <b>478565</b> | 190              | 58               | 3                           | 10.5        | B               |
| <b>GILERA</b>         |                  |           |               |                  |                  |                             |             |                 |
| universel 50          |                  | 1         | <b>478565</b> | 190              | 58               | 3                           | 8.4         | A               |
| universel 50          |                  | 1         | <b>478565</b> | 190              | 58               | 3                           | 8.5         | B               |
| universel 50          |                  | 1         | <b>478565</b> | 190              | 58               | 3                           | 8.5         | C               |
| universel 50          |                  | 1         | <b>478565</b> | 190              | 58               | 3                           | 10.5        | B               |
| <b>HONDA</b>          |                  |           |               |                  |                  |                             |             |                 |
| universel 50          |                  | 1         | <b>478565</b> | 190              | 58               | 3                           | 8.4         | A               |
| universel 50          |                  | 1         | <b>478565</b> | 190              | 58               | 3                           | 8.5         | B               |
| universel 50          |                  | 1         | <b>478565</b> | 190              | 58               | 3                           | 8.5         | C               |
| universel 50          |                  | 1         | <b>478565</b> | 190              | 58               | 3                           | 10.5        | B               |
| <b>MALAGUTI</b>       |                  |           |               |                  |                  |                             |             |                 |
| universel 50          |                  | 1         | <b>478565</b> | 190              | 58               | 3                           | 8.4         | A               |
| universel 50          |                  | 1         | <b>478565</b> | 190              | 58               | 3                           | 8.5         | B               |
| universel 50          |                  | 1         | <b>478565</b> | 190              | 58               | 3                           | 8.5         | C               |
| universel 50          |                  | 1         | <b>478565</b> | 190              | 58               | 3                           | 10.5        | B               |
| <b>PEUGEOT</b>        |                  |           |               |                  |                  |                             |             |                 |
| SPEEDFIGHT            | avant et arrière | 4         | <b>466316</b> | 179              | 58.2             | 3                           | 10.60       | B               |
| SPEEDFIGHT            | avant et arrière | 4         | <b>466316</b> | 179              | 58.2             | 3                           | 10.70       | B               |
| SPEEDFIGHT            | avant et arrière | 4         | <b>466316</b> | 179              | 58.2             | 3                           | 11.70       | B               |



Sélection  
**CGN**

## DISQUE UNIVERSEL SCOOTER

|                |       | N° schéma | Référence     | Ø extérieur (mm) | Ø intérieur (mm) | Nombre de trous de fixation | Ø trou (mm) | Type de perçage |
|----------------|-------|-----------|---------------|------------------|------------------|-----------------------------|-------------|-----------------|
| <b>PEUGEOT</b> |       |           |               |                  |                  |                             |             |                 |
| TREKKER        | avant | 3         | <b>466317</b> | 190              | 58.5             | 3                           | 8.7         | B               |
| TREKKER        | avant | 3         | <b>466317</b> | 190              | 58.5             | 3                           | 8.9         | D               |
| TREKKER        | avant | 3         | <b>466317</b> | 190              | 58.5             | 3                           | 10.5        | B               |
| <b>PIAGGIO</b> |       |           |               |                  |                  |                             |             |                 |
| universel 50   |       | 1         | <b>478565</b> | 190              | 58               | 3                           | 8.4         | A               |
| universel 50   |       | 1         | <b>478565</b> | 190              | 58               | 3                           | 8.5         | B               |
| universel 50   |       | 1         | <b>478565</b> | 190              | 58               | 3                           | 8.5         | C               |
| universel 50   |       | 1         | <b>478565</b> | 190              | 58               | 3                           | 10.5        | B               |
| TYPHOON        |       | 3         | <b>466317</b> | 190              | 58.5             | 3                           | 8.7         | B               |
| TYPHOON        |       | 3         | <b>466317</b> | 190              | 58.5             | 3                           | 8.9         | D               |
| TYPHOON        |       | 3         | <b>466317</b> | 190              | 58.5             | 3                           | 10.5        | B               |
| <b>SYM</b>     |       |           |               |                  |                  |                             |             |                 |
| universel 50   |       | 1         | <b>478565</b> | 190              | 58               | 3                           | 8.4         | A               |
| universel 50   |       | 1         | <b>478565</b> | 190              | 58               | 3                           | 8.5         | B               |
| universel 50   |       | 1         | <b>478565</b> | 190              | 58               | 3                           | 8.5         | C               |
| universel 50   |       | 1         | <b>478565</b> | 190              | 58               | 3                           | 10.5        | B               |

**MALOSSI**

## DISQUE SCOOTER

|                 |       | N° schéma | Référence     | Ø extérieur (mm) | Ø intérieur (mm) | Nombre de trous de fixation | Ø trou (mm) | Type de perçage |
|-----------------|-------|-----------|---------------|------------------|------------------|-----------------------------|-------------|-----------------|
| <b>APRILIA</b>  |       |           |               |                  |                  |                             |             |                 |
| SR50            | avant | 5         | <b>468125</b> | 190              | 60               | 3                           | 8.5         | C               |
| <b>MALAGUTI</b> |       |           |               |                  |                  |                             |             |                 |
| F12             | avant | 5         | <b>468125</b> | 190              | 60               | 3                           | 8.5         | C               |
| <b>MBK</b>      |       |           |               |                  |                  |                             |             |                 |
| OVETTO          | avant | 5         | <b>468125</b> | 190              | 60               | 3                           | 8.5         | C               |
| STUNT           | avant | 5         | <b>468125</b> | 190              | 60               | 3                           | 8.5         | C               |
| <b>PEUGEOT</b>  |       |           |               |                  |                  |                             |             |                 |
| TREKKER         | avant | 5         | <b>468125</b> | 190              | 60               | 3                           | 8.5         | C               |
| <b>PIAGGIO</b>  |       |           |               |                  |                  |                             |             |                 |
| NRG             | avant | 5         | <b>468125</b> | 190              | 60               | 3                           | 8.5         | C               |
| TYPHOON         | avant | 5         | <b>468125</b> | 190              | 60               | 3                           | 8.5         | C               |



DISQUE SCOOTER

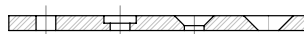

(A) (B) (C) (D)

|                                      |         | N° schéma | Référence     | Ø extérieur (mm) | Ø intérieur (mm) | Nombre de trous de fixation | Ø trou (mm) | Type de perçage |
|--------------------------------------|---------|-----------|---------------|------------------|------------------|-----------------------------|-------------|-----------------|
| <b>ADLY</b>                          |         |           |               |                  |                  |                             |             |                 |
| FOX 2006->2011                       | avant   | 14        | <b>320158</b> | 155              | 40.6             | 3                           | 10.5        | B               |
| JET 2006->2011                       | avant   | 14        | <b>320158</b> | 155              | 40.6             | 3                           | 10.5        | B               |
| PREDATOR                             | avant   | 20        | <b>277093</b> | 190              | 58               | 3                           | 8.75        | B               |
| SUPER SONIC                          | avant   | 20        | <b>277093</b> | 190              | 58               | 3                           | 8.75        | B               |
| <b>APRILIA</b>                       |         |           |               |                  |                  |                             |             |                 |
| AMICO 1992->1999                     | avant   | 14        | <b>320158</b> | 155              | 40.6             | 3                           | 10.5        | B               |
| MOJITO 1994->2012                    | avant   | 7         | <b>465366</b> | 190              | 58               | 3                           | 8.5         | A               |
| PEGASO 1992->2005                    | avant   | 14        | <b>320158</b> | 155              | 40.6             | 3                           | 10.5        | B               |
| RALLY 1995->2005                     | avant   | 7         | <b>465366</b> | 190              | 58               | 3                           | 8.5         | A               |
| RALLY                                | avant   | 7         | <b>465366</b> | 190              | 58               | 3                           | 8.5         | A               |
| SONIC 1992->2008                     | avant   | 14        | <b>320158</b> | 155              | 40.6             | 3                           | 10.5        | B               |
| SR50                                 | avant   | 7         | <b>465366</b> | 190              | 58               | 3                           | 8.5         | A               |
| SR50                                 | arrière | 7         | <b>465366</b> | 190              | 58               | 3                           | 8.5         | A               |
| SR MOTARD                            | avant   | 10        | <b>320067</b> | 220              | 58               | 5                           | 6.5         | A               |
| <b>BETA</b>                          |         |           |               |                  |                  |                             |             |                 |
| ARK 1997->2012                       | avant   | 7         | <b>465366</b> | 190              | 58               | 3                           | 8.5         | A               |
| <b>GPI</b>                           |         |           |               |                  |                  |                             |             |                 |
| ARRAGON 2006->2008                   | avant   | 20        | <b>277093</b> | 190              | 58               | 3                           | 8.75        | B               |
| ARRAGON GP   PADDOCK   SP 2007->2009 | avant   | 20        | <b>277093</b> | 190              | 58               | 3                           | 8.75        | B               |
| HUSSAR 2001->2006                    | avant   | 20        | <b>277093</b> | 190              | 58               | 3                           | 8.75        | B               |
| OLIVER 2001->2006                    | avant   | 20        | <b>277093</b> | 190              | 58               | 3                           | 8.75        | B               |
| POPCORN 2001->2006                   | avant   | 20        | <b>277093</b> | 190              | 58               | 3                           | 8.75        | B               |
| <b>DERBI</b>                         |         |           |               |                  |                  |                             |             |                 |
| BOULEVARD   VARIANT                  | avant   | 10        | <b>320067</b> | 220              | 58               | 5                           | 6.5         | A               |
| <b>GILERA</b>                        |         |           |               |                  |                  |                             |             |                 |
| DNA 2000->2005                       | avant   | 61        | <b>495192</b> | 240              | 125              | 5                           | 6.5         | A               |
| DNA 2006->                           | avant   | 62        | <b>483310</b> | 240              | 125              | 5                           | 6.5         | A               |
| DNA 2000->2006                       | arriere | 9         | <b>483312</b> | 200              | 96               | 5                           | 6.5         | A               |
| ICE                                  | avant   | 9         | <b>483312</b> | 200              | 96               | 5                           | 6.5         | A               |
| RUNNER 2000->2008                    | avant   | 10        | <b>320067</b> | 220              | 58               | 5                           | 6.5         | A               |
| RUNNER 1998->2008                    | arriere | 11        | <b>320097</b> | 175              | 73               | 5                           | 6.5         | A               |
| RUNNER 2005->2016                    | avant   | 21        | <b>483303</b> | 220              | 105              | 6                           | 6.5         | A               |
| RUNNER 2017->                        | avant   | 63        | <b>483304</b> | 240              | 105              | 6                           | 6.5         | A               |
| STALKER                              | avant   | 7         | <b>465366</b> | 190              | 58               | 3                           | 8.5         | A               |
| <b>KYMCO</b>                         |         |           |               |                  |                  |                             |             |                 |
| AGILITY 50/125                       | avant   | 64        | <b>483316</b> | 180              | 58               | 3                           | 10.5        | B               |
| DINK 50 1998->2002                   | avant   | 64        | <b>483316</b> | 180              | 58               | 3                           | 10.5        | B               |
| DINK CLASSIC 50 2002->               | avant   | 12        | <b>483317</b> | 220              | 58               | 5                           | 10.4        | B               |
| FEVER ZX                             | avant   | 64        | <b>483316</b> | 180              | 58               | 3                           | 10.5        | B               |



# DISQUE SCOOTER

# DISQUE DE FREIN / BRAKE DISK

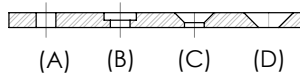

|   |         | N° schéma | Référence     | Ø extérieur (mm) | Ø intérieur (mm) | Nombre de trous de fixation | Ø trou (mm) | Type de perçage |
|---|---------|-----------|---------------|------------------|------------------|-----------------------------|-------------|-----------------|
| <b>KYMCO</b>                            |         |           |               |                  |                  |                             |             |                 |
| SUPER 9                                 | avant   | 64        | <b>483316</b> | 180              | 58               | 3                           | 10.5        | B               |
| TOP BOY 2000->2007                      | avant   | 64        | <b>483316</b> | 180              | 58               | 3                           | 10.5        | B               |
| VITALITY 2 temps ET 4 temps 1997->2006  | avant   | 64        | <b>483316</b> | 180              | 58               | 3                           | 10.5        | B               |
| YAGER                                   | avant   | 64        | <b>483316</b> | 180              | 58               | 3                           | 10.5        | B               |
| YUP 2000->2009                          | avant   | 64        | <b>483316</b> | 180              | 58               | 3                           | 10.5        | B               |
| <b>KSR</b>                              |         |           |               |                  |                  |                             |             |                 |
| EPICO 2012->2017                        | avant   | 20        | <b>277093</b> | 190              | 58               | 3                           | 8.75        | B               |
| CRACKER 2 temps et 4 temps              | avant   | 20        | <b>277093</b> | 190              | 58               | 3                           | 8.75        | B               |
| IDEO 2 temps 2005->2013                 | avant   | 20        | <b>277093</b> | 190              | 58               | 3                           | 8.75        | B               |
| RACE 2 2 temps et 4 temps 2010->2014    | avant   | 20        | <b>277093</b> | 190              | 58               | 3                           | 8.75        | B               |
| ROC 2008->2011                          | avant   | 20        | <b>277093</b> | 190              | 58               | 3                           | 8.75        | B               |
| SIRION 2 temps et 4 temps               | avant   | 20        | <b>277093</b> | 190              | 58               | 3                           | 8.75        | B               |
| VERTIGO 4 temps                         | avant   | 20        | <b>277093</b> | 190              | 58               | 3                           | 8.75        | B               |
| XOR 2 temps et 4 temps 2005->2013       | avant   | 20        | <b>277093</b> | 190              | 58               | 3                           | 8.75        | B               |
| <b>MASH</b>                             |         |           |               |                  |                  |                             |             |                 |
| BIBOP 2014->2015                        | avant   | 20        | <b>277093</b> | 190              | 58               | 3                           | 8.75        | B               |
| <b>MBK</b>                              |         |           |               |                  |                  |                             |             |                 |
| BOOSTER ->1999                          | avant   | 14        | <b>320158</b> | 155              | 40.6             | 3                           | 10.5        | B               |
| BOOSTER 1999->2004                      | avant   | 15        | <b>332746</b> | 180              | 48               | 4                           | 10.5        | B               |
| BOOSTER 2004 ->                         | avant   | 15        | <b>332746</b> | 180              | 48               | 4                           | 10.5        | B               |
| BOOSTER NG   ROCKET ->1998              | avant   | 15        | <b>332746</b> | 180              | 48               | 4                           | 10.5        | B               |
| BOOSTER NG   ROCKET 1999->              | avant   | 16        | <b>440745</b> | 190              | 58               | 3                           | 10.4        | B               |
| MACH G                                  | avant   | 7         | <b>465366</b> | 190              | 58               | 3                           | 8.5         | A               |
| NITRO                                   | avant   | 16        | <b>440745</b> | 190              | 58               | 3                           | 10.4        | B               |
| NITRO                                   | arrière | 16        | <b>440745</b> | 190              | 58               | 3                           | 10.4        | B               |
| OVETTO ->2005                           | avant   | 7         | <b>465366</b> | 190              | 58               | 3                           | 8.5         | A               |
| STUNT ->2009   NAKED 2005->             | avant   | 7         | <b>465366</b> | 190              | 58               | 3                           | 8.5         | A               |
| STUNT NAKED 2005->                      | avant   | 60        | <b>493791</b> | 190              | 45               | 4                           | 10.5        | A               |
| <b>PEUGEOT</b>                          |         |           |               |                  |                  |                             |             |                 |
| BUXY   BUXY RS                          | avant   | 20        | <b>277093</b> | 190              | 58               | 3                           | 8.75        | B               |
| ELYSEO                                  | avant   | 13        | <b>440742</b> | 190              | 58               | 3                           | 9.5         | D               |
| ELYSTAR   ELYSEO                        | arrière | 17        | <b>320071</b> | 180              | 58               | 3                           | 9.25        | C               |
| KISBEE 2 temps et 4 temps               | avant   | 18        | <b>483385</b> | 170              | 46               | 3                           | 8.6         | B               |
| KISBEE 2 temps et 4 temps   STREET ZONE | avant   | 19        | <b>477498</b> | 170              | 65               | 3                           | 8.5         | A               |
| LUDIX BLASTER                           | avant   | 19        | <b>477498</b> | 170              | 65               | 3                           | 8.5         | A               |
| LUDIX BLASTER   SNAKE   TRENDY          | avant   | 14        | <b>320158</b> | 155              | 40.6             | 3                           | 10.5        | B               |
| SQUAB                                   | avant   | 20        | <b>277093</b> | 190              | 58               | 3                           | 8.75        | B               |
| VIVACITY                                | avant   | 13        | <b>440742</b> | 190              | 58               | 3                           | 9.5         | D               |



## DISQUE SCOOTER

## DISQUE DE FREIN / BRAKE DISK

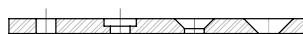

(A) (B) (C) (D)

|                                     |         | N° schéma | Référence     | Ø extérieur (mm) | Ø intérieur (mm) | Nombre de trous de fixation | Ø trou (mm) | Type de perçage |
|-------------------------------------|---------|-----------|---------------|------------------|------------------|-----------------------------|-------------|-----------------|
| <b>PEUGEOT</b>                      |         |           |               |                  |                  |                             |             |                 |
| SPEEDAKE                            | avant   | 20        | <b>277093</b> | 190              | 58               | 3                           | 8.75        | B               |
| SPEEDFIGHT 1 et 2                   | avant   | 17        | <b>320071</b> | 180              | 58               | 3                           | 9.25        | C               |
| SPEEDFIGHT 1 et 2                   | arriere | 17        | <b>320071</b> | 180              | 58               | 3                           | 9.25        | C               |
| SV50                                | avant   | 20        | <b>277093</b> | 190              | 58               | 3                           | 8.75        | B               |
| TKR                                 | avant   | 20        | <b>277093</b> | 190              | 58               | 3                           | 8.75        | B               |
| TREKKER                             | avant   | 13        | <b>440742</b> | 190              | 58               | 3                           | 9.5         | D               |
| TREKKER                             | avant   | 20        | <b>277093</b> | 190              | 58               | 3                           | 8.75        | B               |
| TREND 2008->2009 10" et 12"         | avant   | 19        | <b>477498</b> | 170              | 65               | 3                           | 8.5         | A               |
| V-CLIC                              | avant   | 14        | <b>320158</b> | 155              | 40.6             | 3                           | 10.5        | B               |
| V-CLIC                              | avant   | 19        | <b>477498</b> | 170              | 65               | 3                           | 8.5         | A               |
| ZENITH                              | avant   | 14        | <b>320158</b> | 155              | 40.6             | 3                           | 10.5        | B               |
| <b>PIAGGIO</b>                      |         |           |               |                  |                  |                             |             |                 |
| FLY 2 temps et 4 temps 2005->       | avant   | 9         | <b>483312</b> | 200              | 96               | 5                           | 6.5         | A               |
| LIBERTY 50   125 2 temps et 4 temps | avant   | 21        | <b>483303</b> | 220              | 105              | 6                           | 6.5         | A               |
| NRG ->2001                          | avant   | 13        | <b>440742</b> | 190              | 58               | 3                           | 9.5         | D               |
| NRG 2004->                          | avant   | 10        | <b>320067</b> | 220              | 58               | 5                           | 6.5         | A               |
| NRG 1996->2014                      | arriere | 11        | <b>320097</b> | 175              | 73               | 5                           | 6.5         | A               |
| TYPHOON ->1999                      | avant   | 13        | <b>440742</b> | 190              | 58               | 3                           | 9.5         | D               |
| TYPHOON 1999->2011                  | avant   | 16        | <b>440745</b> | 190              | 58               | 3                           | 10.4        | B               |
| TYPHOON 2011->                      | avant   | 10        | <b>320067</b> | 220              | 58               | 5                           | 6.5         | A               |
| VESPA ET2   ET4   LX                | avant   | 9         | <b>483312</b> | 200              | 96               | 5                           | 6.5         | A               |
| VESPA PRIMAVERA 2013->              | avant   | 9         | <b>483312</b> | 200              | 96               | 5                           | 6.5         | A               |
| VESPA S 2008->2013                  | avant   | 9         | <b>483312</b> | 200              | 96               | 5                           | 6.5         | A               |
| VESPA S PRINT 2015->                | avant   | 9         | <b>483312</b> | 200              | 96               | 5                           | 6.5         | A               |
| ZIP 1995->2000                      | avant   | 14        | <b>320158</b> | 155              | 40.6             | 3                           | 10.5        | B               |
| ZIP 2001->                          | avant   | 11        | <b>320097</b> | 175              | 73               | 5                           | 6.5         | A               |
| ZIP SP LC 1996->2016                | avant   | 9         | <b>483312</b> | 200              | 96               | 5                           | 6.5         | A               |
| <b>PGO</b>                          |         |           |               |                  |                  |                             |             |                 |
| BIG MAX 1994->2002                  | avant   | 14        | <b>320158</b> | 155              | 40.6             | 3                           | 10.5        | B               |
| PMX   PMS 1999->2003                | avant   | 20        | <b>277093</b> | 190              | 58               | 3                           | 8.75        | B               |
| TR3 2003->2004                      | avant   | 20        | <b>277093</b> | 190              | 58               | 3                           | 8.75        | B               |
| T-REX 1999->                        | avant   | 20        | <b>277093</b> | 190              | 58               | 3                           | 8.75        | B               |
| <b>RIEJU</b>                        |         |           |               |                  |                  |                             |             |                 |
| MRT                                 | avant   | 40        | <b>483296</b> | 260              | 108              | 6                           | 6.5         | A               |
| MRT ->2009                          | arriere | 37        | <b>320014</b> | 218              | 90               | 3                           | 8.5         | C               |
| MRT PRO 2012->2014                  | avant   | 31        | <b>483293</b> | 300              | 108              | 6                           | 6           | A               |
| MRT PRO 2012->2014                  | arriere | 58        | <b>483295</b> | 200              | 62               | 3                           | 8.5         | A               |
| MRX 2003->2006                      | avant   | 40        | <b>483296</b> | 260              | 108              | 6                           | 6.5         | A               |
| MRX 2003->2006                      | arriere | 58        | <b>483295</b> | 200              | 62               | 3                           | 8.5         | A               |





# DISQUE SCOOTER

# DISQUE DE FREIN / BRAKE DISK

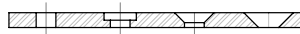

(A) (B) (C) (D)

|                               |         | N° schéma | Référence     | Ø extérieur (mm) | Ø intérieur (mm) | Nombre de trous de fixation | Ø trou (mm) | Type de perçage |
|-------------------------------|---------|-----------|---------------|------------------|------------------|-----------------------------|-------------|-----------------|
| <b>SYM</b>                    |         |           |               |                  |                  |                             |             |                 |
| DD                            | avant   | 22        | <b>485299</b> | 160              | 57               | 3                           | 10.5        | B               |
| FANTIC 1998->2006             | avant   | 7         | <b>465366</b> | 190              | 58               | 3                           | 8.5         | A               |
| FIDDEL S   2   3              | avant   | 20        | <b>277093</b> | 190              | 58               | 3                           | 8.75        | B               |
| JET 1995->2010                | avant   | 7         | <b>465366</b> | 190              | 58               | 3                           | 8.5         | A               |
| JUNGLE 1995->2002             | avant   | 7         | <b>465366</b> | 190              | 58               | 3                           | 8.5         | A               |
| ALLO                          | avant   | 20        | <b>277093</b> | 190              | 58               | 3                           | 8.75        | B               |
| ORBITE 2014->                 | avant   | 20        | <b>277093</b> | 190              | 58               | 3                           | 8.75        | B               |
| MIO                           | avant   | 22        | <b>485299</b> | 160              | 57               | 3                           | 10.5        | B               |
| SUPER FANCY 2006->            | avant   | 22        | <b>485299</b> | 160              | 57               | 3                           | 10.5        | B               |
| SYMPLY 2 2014->               | avant   | 20        | <b>277093</b> | 190              | 58               | 3                           | 8.75        | B               |
| X PRO                         | avant   | 20        | <b>277093</b> | 190              | 58               | 3                           | 8.75        | B               |
| <b>TGB</b>                    |         |           |               |                  |                  |                             |             |                 |
| 101R 2004->2009               | avant   | 20        | <b>277093</b> | 190              | 58               | 3                           | 8.75        | B               |
| 202 CLASSIC 2003->2014        | avant   | 20        | <b>277093</b> | 190              | 58               | 3                           | 8.75        | B               |
| 303 2002->2014                | avant   | 20        | <b>277093</b> | 190              | 58               | 3                           | 8.75        | B               |
| AKROS TEC 1994->2004          | avant   | 20        | <b>277093</b> | 190              | 58               | 3                           | 8.75        | B               |
| CITY 2 temps 2007->2008       | avant   | 20        | <b>277093</b> | 190              | 58               | 3                           | 8.75        | B               |
| CITY 4 temps 2007->2011       | avant   | 20        | <b>277093</b> | 190              | 58               | 3                           | 8.75        | B               |
| DELIVERY   EXPRESS 2004->2012 | avant   | 20        | <b>277093</b> | 190              | 58               | 3                           | 8.75        | B               |
| F409 CRUISE 2002->2005        | avant   | 20        | <b>277093</b> | 190              | 58               | 3                           | 8.75        | B               |
| KEY WEST 2 temps 2006->2015   | avant   | 20        | <b>277093</b> | 190              | 58               | 3                           | 8.75        | B               |
| <b>YAMAHA</b>                 |         |           |               |                  |                  |                             |             |                 |
| BW'S ->1999                   | avant   | 14        | <b>320158</b> | 155              | 40.6             | 3                           | 10.5        | B               |
| BW'S 1999->2004               | avant   | 15        | <b>332746</b> | 180              | 48               | 4                           | 10.5        | B               |
| BW'S 2004 ->                  | avant   | 15        | <b>332746</b> | 180              | 48               | 4                           | 10.5        | B               |
| NEXT                          | avant   | 15        | <b>332746</b> | 180              | 48               | 4                           | 10.5        | B               |
| NEXT                          | avant   | 16        | <b>440745</b> | 190              | 58               | 3                           | 10.4        | B               |
| JOG R                         | avant   | 7         | <b>465366</b> | 190              | 58               | 3                           | 8.5         | A               |
| AEROX                         | avant   | 16        | <b>440745</b> | 190              | 58               | 3                           | 10.4        | B               |
| AEROX                         | arrière | 16        | <b>440745</b> | 190              | 58               | 3                           | 10.4        | B               |
| NEOS                          | avant   | 7         | <b>465366</b> | 190              | 58               | 3                           | 8.5         | A               |
| SLIDER ->2009   naked 2005->  | avant   | 7         | <b>465366</b> | 190              | 58               | 3                           | 8.5         | A               |
| SLIDER NAKED 2005->           | avant   | 60        | <b>493791</b> | 190              | 45               | 4                           | 10.5        | A               |



DISQUE MOTO

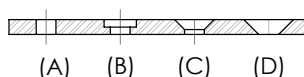

|   |         | N° schéma | Référence     | Ø extérieur (mm) | Ø intérieur (mm) | Nombre de trous de fixation | Ø trou (mm) | Type de perçage |
|---|---------|-----------|---------------|------------------|------------------|-----------------------------|-------------|-----------------|
| <b>ADLY</b>                               |         |           |               |                  |                  |                             |             |                 |
| ROAD TRACER 2004->2006                    | avant   | 14        | <b>320158</b> | 155              | 40.6             | 3                           | 10.5        | B               |
| <b>APRILIA</b>                            |         |           |               |                  |                  |                             |             |                 |
| RS50 ->1998                               | avant   | 65        | <b>319947</b> | 290              | 155              | 6                           | 12          | B               |
| RS 1998->2006   TUONO                     | avant   | 23        | <b>319985</b> | 280              | 155              | 5                           | 6.5         | B               |
| RS 1998->2006   TUONO                     | arriere | 24        | <b>319990</b> | 220              | 100              | 5                           | 8.5         | C               |
| RS 2006->2010                             | avant   | 26        | <b>485125</b> | 300              | 90               | 6                           | 6           | A               |
| RS 2006->2010                             | arriere | 25        | <b>485124</b> | 180              | 57               | 6                           | 6.5         | A               |
| RS4                                       | avant   | 26        | <b>485125</b> | 300              | 90               | 6                           | 6           | A               |
| RS4                                       | arriere | 50        | <b>440735</b> | 220              | 57               | 6                           | 6.5         | A               |
| <b>APRILIA</b>                            |         |           |               |                  |                  |                             |             |                 |
| RX 1998->2004                             | avant   | 43        | <b>319966</b> | 230              | 112              | 6                           | 6.5         | B               |
| RX 2005->                                 | avant   | 35        | <b>320000</b> | 259              | 108              | 6                           | 6.5         | A               |
| RX 2005->                                 | arriere | 37        | <b>320014</b> | 218              | 90               | 3                           | 8.5         | C               |
| SX50 2006->                               | avant   | 31        | <b>483293</b> | 300              | 108              | 6                           | 6           | A               |
| SX50 2006->                               | arriere | 37        | <b>320014</b> | 218              | 90               | 3                           | 8.5         | C               |
| <b>BETA</b>                               |         |           |               |                  |                  |                             |             |                 |
| BETA 50RR 2010->2012                      | avant   | 26        | <b>485125</b> | 300              | 90               | 6                           | 6           | A               |
| BETA ENDURO RACING 2006->2012             | avant   | 28        | <b>485543</b> | 220              | 100              | 4                           | 6.5         | B               |
| BETA ENDURO RACING 2006->2012             | arriere | 28        | <b>485543</b> | 220              | 100              | 4                           | 6.5         | B               |
| BETA RR 2015->                            | avant   | 51        | <b>440734</b> | 260              | 90               | 6                           | 6.5         | A               |
| BETA RR   SM 2015->                       | arriere | 29        | <b>485544</b> | 220              | 105              | 6                           | 6.5         | B               |
| <b>DERBI</b>                              |         |           |               |                  |                  |                             |             |                 |
| DERBI SENDA DRD                           | avant   | 26        | <b>485125</b> | 300              | 90               | 6                           | 6           | A               |
| DERBI SENDA DRD 2004->                    | avant   | 30        | <b>485542</b> | 260              | 108              | 6                           | 6.5         | A               |
| DERBI SENDA DRD PRO   SM50   SMX PRO50    | avant   | 31        | <b>483293</b> | 300              | 108              | 6                           | 6           | A               |
| DERBI SENDA L   R ->1999                  | avant   | 32        | <b>452079</b> | 218              | 90               | 3                           | 8.5         | C               |
| DERBI SENDA R 2000->                      | avant   | 33        | <b>465373</b> | 240              | 108.5            | 6                           | 6.5         | A               |
| DERBI SENDA R SM   DRD 2002->             | avant   | 34        | <b>369567</b> | 259              | 108              | 6                           | 6.5         | A               |
| DERBI SENDA R-SM 2002->   DRD R-SM 2003-> | avant   | 35        | <b>320000</b> | 259              | 108              | 6                           | 6.5         | A               |
| GPR 2005->2009                            | arriere | 25        | <b>485124</b> | 180              | 57               | 6                           | 6.5         | A               |
| GPR 2005->2009                            | avant   | 26        | <b>485125</b> | 300              | 90               | 6                           | 6           | A               |
| GPR 2005->2009                            | arriere | 25        | <b>485124</b> | 180              | 57               | 6                           | 6.5         | A               |
| SENDA DRD                                 | arriere | 36        | <b>465375</b> | 220              | 62               | 3                           | 10.5        | A               |
| SENDA R-SM                                | arriere | 37        | <b>320014</b> | 218              | 90               | 3                           | 8.5         | C               |



# DISQUE MOTO

# DISQUE DE FREIN / BRAKE DISK

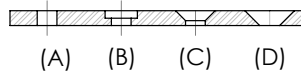

|                                       |         | N° schéma | Référence     | Ø extérieur (mm) | Ø intérieur (mm) | Nombre de trous de fixation | Ø trou (mm) | Type de perçage |
|---------------------------------------|---------|-----------|---------------|------------------|------------------|-----------------------------|-------------|-----------------|
| <b>GILERA</b>                         |         |           |               |                  |                  |                             |             |                 |
| GSM 50                                | avant   | 38        | <b>440747</b> | 220              | 108              | 6                           | 6.5         | C               |
| GSM50                                 | arrière | 39        | <b>440746</b> | 184              | 60               | 6                           | 8.5         | A               |
| GP1 1997->2001                        | arrière | 50        | <b>440735</b> | 220              | 57               | 6                           | 6.5         | A               |
| GP1 2001->2003                        | arriere | 11        | <b>320097</b> | 175              | 73               | 5                           | 6.5         | A               |
| RCR 2011->                            | avant   | 30        | <b>485542</b> | 260              | 108              | 6                           | 6.5         | A               |
| RCR 2011->                            | arrière | 36        | <b>465375</b> | 220              | 62               | 3                           | 10.5        | A               |
| SMT 2011->                            | avant   | 30        | <b>485542</b> | 260              | 108              | 6                           | 6.5         | A               |
| SMT 2011->                            | arrière | 36        | <b>465375</b> | 220              | 62               | 3                           | 10.5        | A               |
| <b>KEEWAY</b>                         |         |           |               |                  |                  |                             |             |                 |
| PIXEL                                 | avant   | 22        | <b>485299</b> | 160              | 57               | 3                           | 10.5        | B               |
| <b>KYMCO</b>                          |         |           |               |                  |                  |                             |             |                 |
| SPIKE                                 | avant   | 40        | <b>483296</b> | 260              | 108              | 6                           | 6.5         | A               |
| SPIKE ->2001                          | avant   | 41        | <b>320105</b> | 220              | 108              | 6                           | 6           | C               |
| <b>MALAGUTI</b>                       |         |           |               |                  |                  |                             |             |                 |
| DRAKON                                | arrière | 9         | <b>483312</b> | 200              | 96               | 5                           | 6.5         | A               |
| XSM SUPERMOTARD 2003->2010            | arriere | 42        | <b>450419</b> | 218              | 62               | 3                           | 8.5         | A               |
| XTM ENDURO 2007->2010                 | arriere | 42        | <b>450419</b> | 218              | 62               | 3                           | 8.5         | A               |
| <b>MBK</b>                            |         |           |               |                  |                  |                             |             |                 |
| X-LIMIT ->2002                        | avant   | 43        | <b>319966</b> | 230              | 112              | 6                           | 6.5         | B               |
| X-LIMIT ENDURO 2003->                 | avant   | 44        | <b>450418</b> | 240              | 108              | 6                           | 6.5         | A               |
| X-LIMIT SM 2003->                     | avant   | 34        | <b>369567</b> | 259              | 108              | 6                           | 6.5         | A               |
| X-LIMIT ENDURO 2003->2005   SM 2003-> | arrière | 42        | <b>450419</b> | 218              | 62               | 3                           | 8.5         | A               |
| X-POWER 2004->                        | avant   | 23        | <b>319985</b> | 280              | 155              | 5                           | 6.5         | B               |
| X-POWER 2004->                        | arrière | 45        | <b>465376</b> | 220              | 105              | 5                           | 6.45        | B               |
| X-POWER ->2003                        | arrière | 46        | <b>320143</b> | 203              | 84               | 4                           | 8           | A               |
| <b>PEUGEOT</b>                        |         |           |               |                  |                  |                             |             |                 |
| XP6 ->2001                            | avant   | 41        | <b>320105</b> | 220              | 108              | 6                           | 6           | C               |
| XP6 2002->                            | arrière | 37        | <b>320014</b> | 218              | 90               | 3                           | 8.5         | C               |
| XP6   XPS 2002->                      | avant   | 47        | <b>465374</b> | 240              | 108.5            | 6                           | 6.5         | C               |
| XP7 SM                                | avant   | 48        | <b>484476</b> | 240              | 90               | 6                           | 6.5         | C               |
| XP7 SM                                | arrière | 49        | <b>484477</b> | 200              | 58               | 6                           | 6.6         | A               |
| XP7 TRAIL                             | avant   | 47        | <b>465374</b> | 240              | 108.5            | 6                           | 6.5         | C               |
| XP7 TRAIL                             | arriere | 49        | <b>483294</b> | 200              | 62               | 3                           | 10.5        | A               |
| XPS                                   | arrière | 49        | <b>483294</b> | 200              | 62               | 3                           | 10.5        | A               |
| XPS STREET                            | avant   | 51        | <b>440734</b> | 260              | 90               | 6                           | 6.5         | A               |
| XPS STREET                            | arrière | 50        | <b>440735</b> | 220              | 57               | 6                           | 6.5         | A               |
| XR6                                   | avant   | 51        | <b>440734</b> | 260              | 90               | 6                           | 6.5         | A               |
| XR6                                   | arrière | 50        | <b>440735</b> | 220              | 57               | 6                           | 6.5         | A               |
| XR7   NK7                             | avant   | 52        | <b>483297</b> | 300              | 90               | 6                           | 6           | C               |
| XR7   NK7                             | arrière | 50        | <b>440735</b> | 220              | 57               | 6                           | 6.5         | A               |



## DISQUE MOTO

## DISQUE DE FREIN / BRAKE DISK

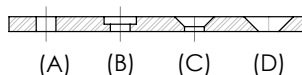

|                                  |         | N° schéma | Référence     | Ø extérieur (mm) | Ø intérieur (mm) | Nombre de trous de fixation | Ø trou (mm) | Type de perçage |
|----------------------------------|---------|-----------|---------------|------------------|------------------|-----------------------------|-------------|-----------------|
| <b>RIEJU</b>                     |         |           |               |                  |                  |                             |             |                 |
| RMX   MRX   MRX PRO              | arrière | 58        | <b>483295</b> | 200              | 62               | 3                           | 8.5         | A               |
| RMX50                            | arrière | 57        | <b>320124</b> | 185              | 80               | 6                           | 16          | A               |
| RS1 ->2001                       | arriere | 65        | <b>440739</b> | 199              | 57               | 5                           | 6.5         | A               |
| RS1                              | arrière | 29        | <b>485544</b> | 220              | 105              | 6                           | 6.5         | B               |
| RS2   NKD                        | avant   | 54        | <b>486943</b> | 280              | 90               | 6                           | 6           | A               |
| RS2   NKD                        | arrière | 53        | <b>486944</b> | 220              | 57               | 6                           | 6.5         | A               |
| RS3   NKD                        | avant   | 56        | <b>485541</b> | 280              | 108              | 6                           | 6.5         | A               |
| RS3   NKD                        | arrière | 55        | <b>485540</b> | 220              | 62               | 3                           | 8.5         | A               |
| SMX 2001->2015                   | avant   | 40        | <b>483296</b> | 260              | 108              | 6                           | 6.5         | A               |
| SMX 2001->2015                   | arriere | 58        | <b>483295</b> | 200              | 62               | 3                           | 8.5         | A               |
| SMX                              | arrière | 49        | <b>484477</b> | 200              | 58               | 6                           | 6.6         | A               |
| SMX                              | arrière | 57        | <b>320124</b> | 185              | 80               | 6                           | 16          | A               |
| SMX   RRX   MRX                  | avant   | 40        | <b>483296</b> | 260              | 108              | 6                           | 6.5         | A               |
| SMX50   RMX50                    | avant   | 59        | <b>320110</b> | 220              | 124              | 6                           | 16          | A               |
| SPIKE 2008->2009                 | avant   | 40        | <b>483296</b> | 260              | 108              | 6                           | 6.5         | A               |
| SPIKE 2008->2009                 | arriere | 58        | <b>483295</b> | 200              | 62               | 3                           | 8.5         | A               |
| SPIKE ->2001                     | avant   | 41        | <b>320105</b> | 220              | 108              | 6                           | 6           | C               |
| SPIKE                            | arrière | 27        | <b>440741</b> | 185              | 80               | 3                           | 8.5         | C               |
| SPIKE                            | arrière | 49        | <b>484477</b> | 200              | 58               | 6                           | 6.6         | A               |
| TANGO 2012->                     | avant   | 40        | <b>483296</b> | 260              | 108              | 6                           | 6.5         | A               |
| TANGO 2007->                     | arriere | 58        | <b>483295</b> | 200              | 62               | 3                           | 8.5         | A               |
| <b>SHERCO</b>                    |         |           |               |                  |                  |                             |             |                 |
| RMX   SHERCO                     | avant   | 30        | <b>485542</b> | 260              | 108              | 6                           | 6.5         | A               |
| SHERCO 2006->2012                | avant   | 30        | <b>485542</b> | 260              | 108              | 6                           | 6.5         | A               |
| SHERCO 2006->2012                | arrière | 55        | <b>485540</b> | 220              | 62               | 3                           | 8.5         | A               |
| SHERCO 2002->2006                | arrière | 55        | <b>485540</b> | 220              | 62               | 3                           | 8.5         | A               |
| <b>SUZUKI</b>                    |         |           |               |                  |                  |                             |             |                 |
| RMX50                            | avant   | 59        | <b>320110</b> | 220              | 124              | 6                           | 16          | A               |
| RMX50   SMX50                    | arrière | 57        | <b>320124</b> | 185              | 80               | 6                           | 16          | A               |
| <b>TOMOS</b>                     |         |           |               |                  |                  |                             |             |                 |
| SE 2005->                        | avant   | 44        | <b>450418</b> | 240              | 108              | 6                           | 6.5         | A               |
| SE 2005->                        | arriere | 42        | <b>450419</b> | 218              | 62               | 3                           | 8.5         | A               |
| <b>YAMAHA</b>                    |         |           |               |                  |                  |                             |             |                 |
| DT ->2002                        | avant   | 43        | <b>319966</b> | 230              | 112              | 6                           | 6.5         | B               |
| DT ENDURO 2003->                 | avant   | 44        | <b>450418</b> | 240              | 108              | 6                           | 6.5         | A               |
| DT SM 2003->                     | avant   | 34        | <b>369567</b> | 259              | 108              | 6                           | 6.5         | A               |
| DT ENDURO 2003->2005   SM 2003-> | arrière | 42        | <b>450419</b> | 218              | 62               | 3                           | 8.5         | A               |
| TZR 2004->                       | avant   | 23        | <b>319985</b> | 280              | 155              | 5                           | 6.5         | B               |
| TZR 2004->                       | arrière | 45        | <b>465376</b> | 220              | 105              | 5                           | 6.45        | B               |
| TZR ->2003                       | arrière | 46        | <b>320143</b> | 203              | 84               | 4                           | 8           | A               |

# DISQUE DE FREIN / BRAKE DISK

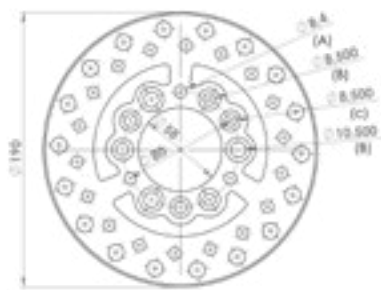
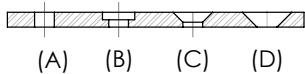

**1**  
478565



**2**  
466315



**3**  
466317

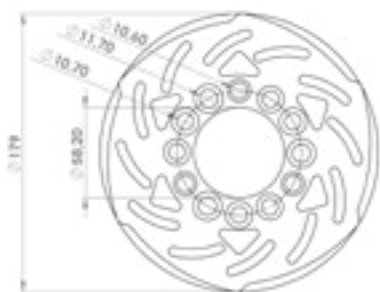

**4**  
466316



**5**  
468125

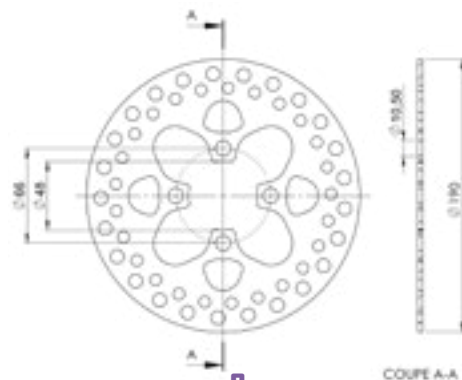

**6**  
493791

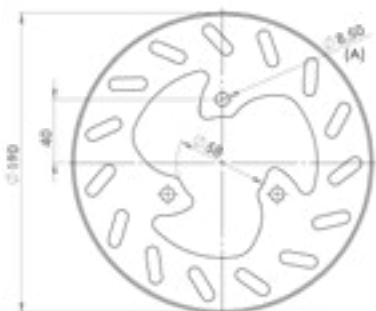

**7**  
465366

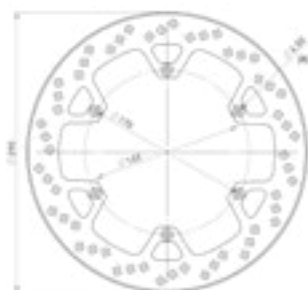

**8**

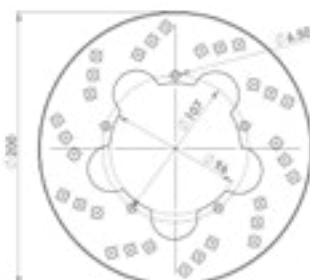

**9**  
483312



**10**  
320067



**11**  
320097

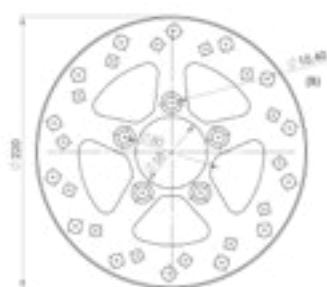

**12**  
483317

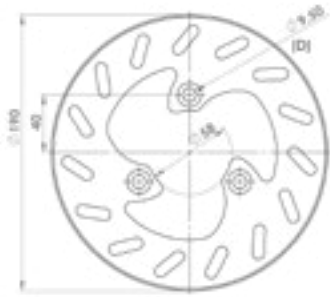
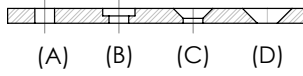

**13**

440742



**14**

320158

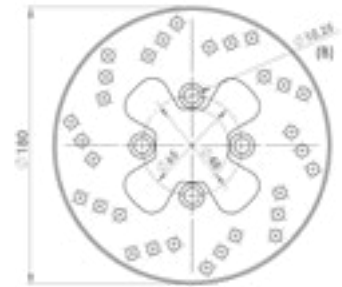

**15**

332746



**16**

440745

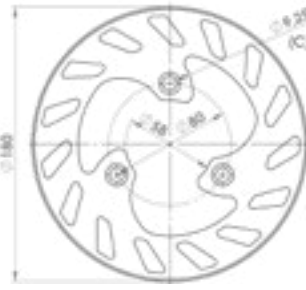

**17**

320071

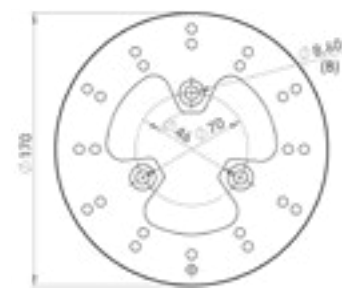

**18**

483385

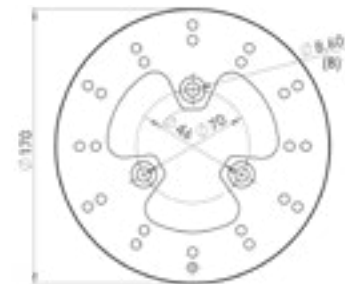

**19**

477498



**20**

277093



**21**

483303

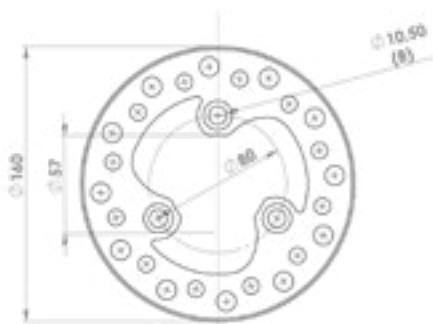

**22**

485299

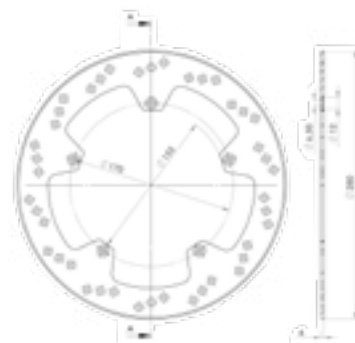

**23**

319985

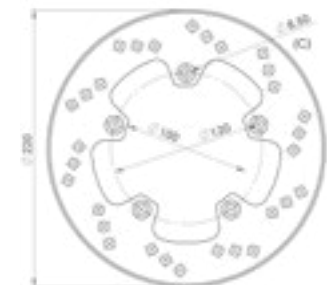

**24**

319990

# DISQUE DE FREIN / BRAKE DISK

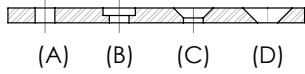

**25**  
485124



**26**  
485125



**27**  
440741



**28**  
485543

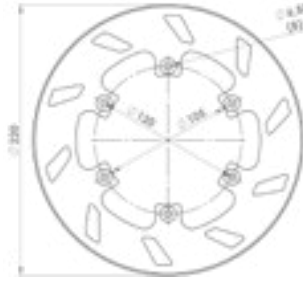

**29**  
485544



**30**  
485542

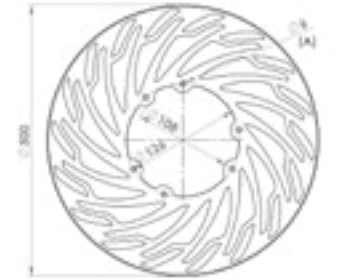

**31**  
483293

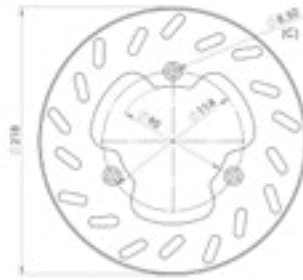

**32**  
452079



**33**  
465373



**34**  
369567



**35**  
320000



**36**  
465375

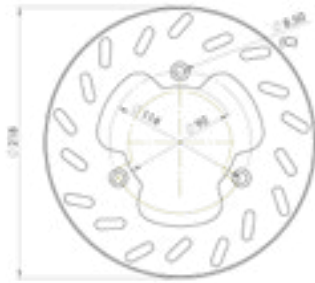
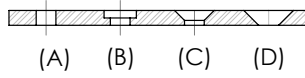

**37**  
320014

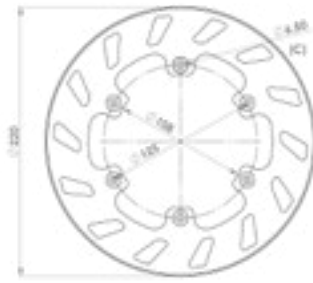

**38**  
440747



**39**  
440746



**40**  
483296

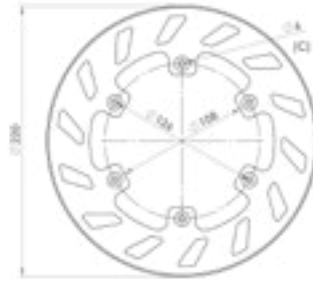

**41**  
320105

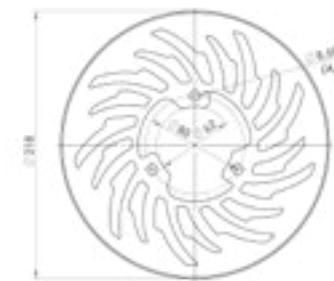

**42**  
450419

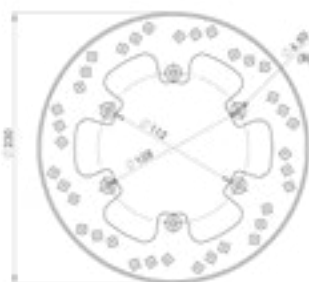

**43**  
319966

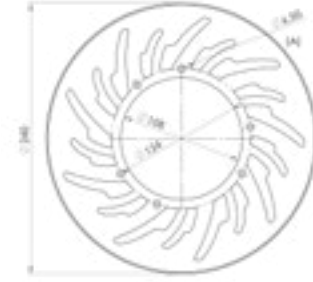

**44**  
450418

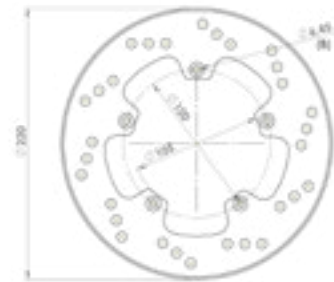

**45**  
465376

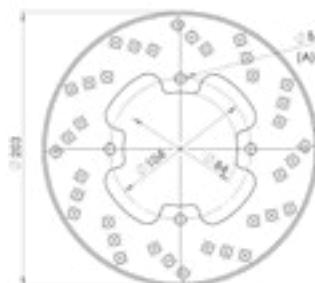

**46**  
320143



**47**  
465374



**48**  
484476



# DISQUE DE FREIN / BRAKE DISK

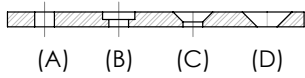

**49**  
484477

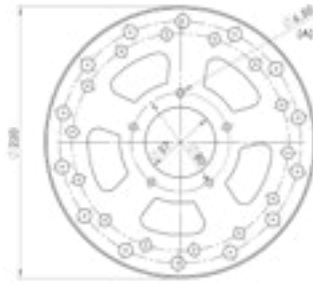

**50**  
440735

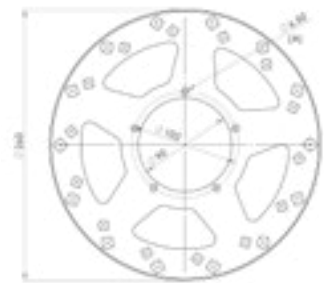

**51**  
440734



**52**  
483297

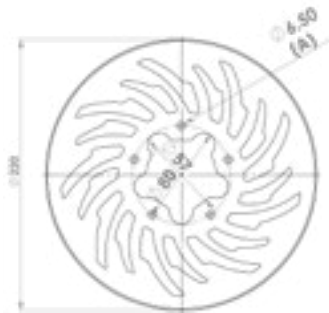

**53**  
486944



**54**  
486943



**55**  
485540



**56**  
485541

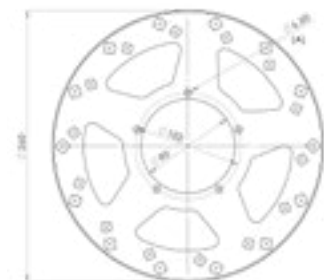

**57**  
320124



**58**  
483295



**59**  
320110

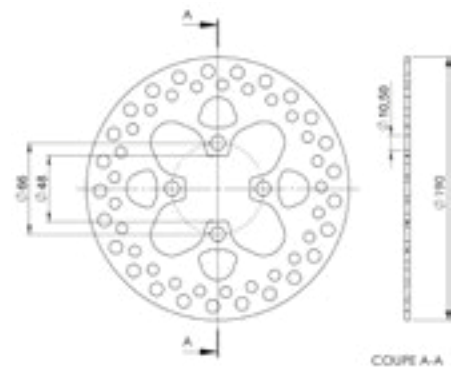







**60**

COUPE A-A

**INFO + :**







Retrouvez les schémas à taille réelle à partir de la **page 495**. Nos plaquettes et mâchoires de frein sont vendues par paire.

|   | N° schéma |  |  |  |  |  |  |
|---|-----------|---|---|--|---|---|---|
| <b>APRILIA</b>                          |           |   |   |  |   |   |   |
| <b>Avant</b>                            |           |   |   |  |   |   |   |
| 50 MX 2000->                            | <b>36</b> | <b>362858</b>   | <b>467875</b>   | <b>467625</b>  |   |   |   |
| 50 RS 1993->1998                        | <b>2</b>  |   | <b>467877</b>   |  |   |   |   |
| 50 RS 1995->1998                        | <b>2</b>  |   | <b>467877</b>   |  |   |   |   |
| 50 RS 2000->2005                        | <b>36</b> | <b>362858</b>   | <b>467875</b>   | <b>467625</b>  |   |   |   |
| 50 RS 2006->2010                        | <b>14</b> | <b>450529</b>   | <b>467879</b>   | <b>294395</b>  |   |   | <b>486834</b>   |
| 50 RS4 2011->                           | <b>21</b> |   | <b>483106</b>   |  |   |   |   |
| 50 RS4 2012->                           | <b>25</b> | <b>297117</b>   | <b>467876</b>   | <b>282873</b>  | <b>464998</b>   |   | <b>486839</b>   |
| 50 RS4 2013->                           | <b>24</b> |   | <b>479778</b>   |  | <b>484831</b>   |   |   |
| 50 RX 1990->1991                        | <b>12</b> | <b>168663</b>   | <b>467872</b>   |  |   |   |   |
| 50 RX 1992->1995                        | <b>36</b> | <b>362858</b>   | <b>467875</b>   | <b>467625</b>  |   |   |   |
| 50 RX 1996->1998                        | <b>2</b>  |   | <b>467877</b>   |  |   |   |   |
| 50 RX 2004->2006                        | <b>36</b> | <b>362858</b>   | <b>467875</b>   | <b>467625</b>  |   |   |   |
| 50 RX 2006->2008                        | <b>6</b>  | <b>287550</b>   | <b>467873</b>   | <b>282888</b>  | <b>464999</b>   | <b>461298</b>   | <b>486828</b>   |
| 50 RX 2008->                            | <b>39</b> | <b>297155</b>   | <b>467888</b>   | <b>467634</b>  |   |   | <b>486837</b>   |
| 50 SCARABEO 1996->2007                  | <b>3</b>  | <b>3374</b>   |   | <b>173506</b>  | <b>464996</b>   | <b>461297</b>   |   |
| 50 SR                                   | <b>1</b>  |   | <b>467870</b>   |  |   |   | <b>486826</b>   |
| 50 SR   DITECH 2000->                   | <b>3</b>  | <b>3374</b>   |   | <b>173506</b>  | <b>464996</b>   | <b>461297</b>   |   |
| 50 SR 1993->1996                        | <b>3</b>  | <b>3374</b>   |   | <b>173506</b>  | <b>464996</b>   | <b>461297</b>   |   |
| 50 SX                                   | <b>33</b> | <b>494261</b>   | <b>479779</b>   |  |   |   |   |
| 125 RS 2008->2010                       | <b>33</b> | <b>494261</b>   | <b>479779</b>   |  |   |   |   |
| 125   150   200 SCARABEO 1999->         | <b>41</b> | <b>450523</b>   |   |  |   |   |   |
| 125   150   250 LEONARDO 1999->         | <b>16</b> | <b>450527</b>   | <b>467880</b>   |  |   |   | <b>486841</b>   |
| 125   150   250 LEONARDO GRIMECA 1999-> | <b>41</b> | <b>450523</b>   |   |  |   |   |   |
| 125   200 ATLANTIC 2003->               | <b>50</b> | <b>452066</b>   |   |  |   |   |   |
| 500 ATLANTIC   SCARABEO 2002->          | <b>41</b> | <b>450523</b>   |   |  |   |   |   |







# PLAQUETTE DE FREIN - MÂCHOIRE DE FREIN / BRAKE PAD - BRAKE SHOE

|                                   | N° schéma |        |        |        |        |        |        |
|-----------------------------------|-----------|--------|--------|--------|--------|--------|--------|
| <b>APRILIA</b>                    |           |        |        |        |        |        |        |
| <b>Arrière</b>                    |           |        |        |        |        |        |        |
| 50 MX 2000->                      | 4         | 297705 | 467878 |        |        |        |        |
| 50 RS 1993->1995                  | 2         |        | 467877 |        |        |        |        |
| 50 RS 1995->1995                  | 2         |        | 467877 |        |        |        |        |
| 50 RS 2000->2005                  | 4         | 297705 | 467878 |        |        |        |        |
| 50 RS 2003->2005                  | 4         | 297705 | 467878 |        |        |        |        |
| 50 RS 2006->2010                  | 6         | 287550 | 467873 | 282888 | 464999 | 461298 | 486828 |
| 50 RS 2006->2010                  | 14        | 450529 | 467879 | 294395 |        |        | 486834 |
| 50 RS4 2013->                     | 24        |        | 479778 |        | 484831 |        |        |
| 50 RX 1990->2006                  | 4         | 297705 | 467878 |        |        |        |        |
| 50 RX 2006->                      | 6         | 287550 | 467873 | 282888 | 464999 | 461298 | 486828 |
| 50 SCARABEO 1998->2005            | 3         | 3374   |        | 173506 | 464996 | 461297 |        |
| 50 SR   DITECH 2000->             | 7         | 450526 |        |        |        |        |        |
| 50 SR 1993->1996                  | 3         | 3374   |        | 173506 | 464996 | 461297 |        |
| 125   150 LEONARDO 1999->         | 16        | 450527 | 467880 |        |        |        | 486841 |
| 125   150 LEONARDO GRIMECA 1999-> | 16        | 450527 | 467880 |        |        |        | 486841 |
| 125   200 ATLANTIC 2003->         | 7         | 450526 |        |        |        |        |        |
| 125 RS 1993->2005                 | 2         |        | 467877 |        |        |        |        |
| 250 LEONARDO 1999->               | 7         | 450526 |        |        |        |        |        |
| 250 LEONARDO GRIMECA 1999->       | 7         | 450526 |        |        |        |        |        |
| <b>BENELLI</b>                    |           |        |        |        |        |        |        |
| <b>Avant</b>                      |           |        |        |        |        |        |        |
| 50 491   491RR   491ST   K2       | 3         | 3374   |        | 173506 | 464996 | 461297 |        |
| <b>Arrière</b>                    |           |        |        |        |        |        |        |
| 491 1997->                        | 5         | 362907 | 467887 |        |        |        | 486827 |
| <b>BETA</b>                       |           |        |        |        |        |        |        |
| <b>Avant</b>                      |           |        |        |        |        |        |        |
| 50 ARK   ARK LC                   | 3         | 3374   |        | 173506 | 464996 | 461297 |        |
| 50 RR                             | 39        | 297155 | 467888 | 467634 |        |        | 486837 |
| 50 RR                             | 23        | 839    |        |        |        |        |        |
| 50   125 RR->2004                 | 37        |        | 485503 |        |        |        | 486829 |
| <b>Arrière</b>                    |           |        |        |        |        |        |        |
| 50   125 RR ->2004                | 57        |        | 485502 |        |        |        | 486845 |
| 50   125 RR 2004->                | 57        |        | 485502 |        |        |        | 486845 |
| <b>BMW</b>                        |           |        |        |        |        |        |        |
| <b>Avant</b>                      |           |        |        |        |        |        |        |
| 600 C SPORT 2012->2015            | 45        | 492561 |        |        |        |        |        |
| 600C                              | 42        | 452075 | 490593 |        |        |        |        |
| 650 C650 GT                       | 45        | 492561 |        |        |        |        |        |
| <b>Arrière</b>                    |           |        |        |        |        |        |        |
| 600 C SPORT 2012->2015            | 45        | 492561 |        |        |        |        |        |
| 650 C650 GT                       | 45        | 492561 |        |        |        |        |        |







# PLAQUETTE DE FREIN - MÂCHOIRE DE FREIN / BRAKE PAD - BRAKE SHOE

|                                   | N° schéma |  |  |  |  |  |  |
|-----------------------------------|-----------|---|---|--|---|---|---|
| <b>CAGIVA</b>                     |           |   |   |  |   |   |   |
| <b>Avant</b>                      |           |   |   |  |   |   |   |
| 50 MITO 1998->                    | 6         | 287550  | 467873  | 282888   | 464999  | 461298  | 486828  |
| 125 MITO 1991->2005               | 2         |   | 467877  |  |   |   |   |
| 125 RAPTOR 2003->                 | 2         |   | 467877  |  |   |   |   |
| <b>Arrière</b>                    |           |   |   |  |   |   |   |
| 50 MITO 1998->                    | 6         | 287550  | 467873  | 282888   | 464999  | 461298  | 486828  |
| 125 MITO 1991->2005               | 2         |   | 467877  |  |   |   |   |
| 125 RAPTOR 2003->                 | 2         |   | 467877  |  |   |   |   |
| <b>CPI</b>                        |           |   |   |  |   |   |   |
| <b>Avant</b>                      |           |   |   |  |   |   |   |
| 50 GTR 2002->2005                 | 5         | 362907  | 467887  |  |   |   | 486827  |
| 50 GTS 2002->2003                 | 5         | 362907  | 467887  |  |   |   | 486827  |
| 50 HUSSAR 2001->2002              | 25        | 297117  | 467876  | 282873   | 464998  |   | 486839  |
| 50 HUSSAR 2003->2005              | 19        |   | 483108  | 482450   |   |   |   |
| 50 OLIVER 2003->2005              | 19        |   | 483108  | 482450   |   |   |   |
| 50 POPCORN 2001->2002             | 25        | 297117  | 467876  | 282873   | 464998  |   | 486839  |
| 50 POPCORN 2003->                 | 19        |   | 483108  | 482450   |   |   |   |
| 50 SUPERCROSS 2003->2005          | 6         | 287550  | 467873  | 282888   | 464999  | 461298  | 486828  |
| 50 SUPERMOTO 2003->2005           | 6         | 287550  | 467873  | 282888   | 464999  | 461298  | 486828  |
| CPI (mâchoire x2)                 | A         |   | 484758  | 4246   | 493269  |   | 486848  |
| <b>Arrière</b>                    |           |   |   |  |   |   |   |
| 50 GTR 2003->2005                 | 14        | 450529  | 467879  | 294395   |   |   | 486834  |
| 50 SUPERCROSS 2003->2005          | 6         | 287550  | 467873  | 282888   | 464999  | 461298  | 486828  |
| 50 SUPERMOTO 2003->2005           | 6         | 287550  | 467873  | 282888   | 464999  | 461298  | 486828  |
| 125 GTS 2002->2003                | 5         | 362907  | 467887  |  |   |   | 486827  |
| CPI (mâchoire x2)                 | A         |   | 484758  | 4246   | 493269  |   | 486848  |
| <b>DAELIM</b>                     |           |   |   |  |   |   |   |
| <b>Avant</b>                      |           |   |   |  |   |   |   |
| 125 HISTORY   MESSAGE II   OTELLO | 9         | 465388  |   | 467649   |   |   |   |
| 125 S2                            | 13        |   | 479518  |  |   |   |   |





# PLAQUETTE DE FREIN - MÂCHOIRE DE FREIN / BRAKE PAD - BRAKE SHOE

|                                  | N° schéma |  |  |  |  |  |  |
|----------------------------------|-----------|---|---|--|---|---|---|
| <b>DERBI</b>                     |           |   |   |  |   |   |   |
| <b>Avant</b>                     |           |   |   |  |   |   |   |
| 50 ATLANTIS 1999->2004           | 6         | 287550  | 467873  | 282888   | 464999  | 461298  | 486828  |
| 50 DRD RACING 2005->             | 36        | 362858  | 467875  | 467625   |   |   |   |
| 50 FENIX 1994->                  | 6         | 287550  | 467873  | 282888   | 464999  | 461298  | 486828  |
| 50 GPR 2004->2010                | 14        | 450529  | 467879  | 294395   |   |   | 486834  |
| 50 GPR 1997->2004                | 39        | 297155  | 467888  | 467634   |   |   | 486837  |
| 50 GPR 1996->1997                | 4         | 297705  | 467878  |  |   |   |   |
| 50 PADDOCK 1996->                | 6         | 287550  | 467873  | 282888   | 464999  | 461298  | 486828  |
| 50 SENDA 1999->                  | 6         | 287550  | 467873  | 282888   | 464999  | 461298  | 486828  |
| 50 SENDA BLACK DEVIL 2004->      | 36        | 362858  | 467875  | 467625   |   |   |   |
| 50 SENDA BLACK EDITION 2003->    | 36        | 362858  | 467875  | 467625   |   |   |   |
| 50 SENDA DRD PRO                 | 25        | 297117  | 467876  | 282873   | 464998  |   | 486839  |
| 50 SENDA DRD RACING 2011->       | 33        | 494261  | 479779  |  |   |   |   |
| 50 SENDA DRD RACING HENGTONG     | 25        | 297117  | 467876  | 282873   | 464998  |   | 486839  |
| 50 SENDA R DRD 2003->2004        | 39        | 297155  | 467888  | 467634   |   |   | 486837  |
| 50 SENDA R DRD 2003->2004        | 6         | 287550  | 467873  | 282888   | 464999  | 461298  | 486828  |
| 50 SENDA R DRD 2005->            | 36        | 362858  | 467875  | 467625   |   |   |   |
| 50 SENDA R DRD 2005->            | 6         | 287550  | 467873  | 282888   | 464999  | 461298  | 486828  |
| 50 SENDA R/X-TREME 1994->2004    | 6         | 287550  | 467873  | 282888   | 464999  | 461298  | 486828  |
| 50 SENDA R/X-TREME 2005->        | 6         | 287550  | 467873  | 282888   | 464999  | 461298  | 486828  |
| 50 SENDA SM   X-TREME 1999->2004 | 6         | 287550  | 467873  | 282888   | 464999  | 461298  | 486828  |
| 50 SENDA SM DRD   X-TREME 2005-> | 36        | 362858  | 467875  | 467625   |   |   |   |
| 50 SENDA SM DRD 2003->2004       | 6         | 287550  | 467873  | 282888   | 464999  | 461298  | 486828  |
| 50 X-TREME                       | 25        | 297117  | 467876  | 282873   | 464998  |   | 486839  |
| 51 SENDA R/X-TREME 2005->        | 6         | 287550  | 467873  | 282888   | 464999  | 461298  | 486828  |
| 125 GPR 2004->2006               | 21        |   | 483106  |  |   |   |   |
| 125 GPR 2004->2006               | 6         | 287550  | 467873  | 282888   | 464999  | 461298  | 486828  |
| 125 GPR                          | 24        |   | 479778  |  | 484831  |   |   |
| 125 SENDA 2003->                 | 36        | 362858  | 467875  | 467625   |   |   |   |
| <b>Arrière</b>                   |           |   |   |  |   |   |   |
| 50 FENIX 1994->                  | 6         | 287550  | 467873  | 282888   | 464999  | 461298  | 486828  |
| 50 GPR 1998->2004                | 6         | 287550  | 467873  | 282888   | 464999  | 461298  | 486828  |
| 50 GPR 2004->                    | 14        | 450529  | 467879  | 294395   |   |   | 486834  |
| 50 SENDA 1999->                  | 6         | 287550  | 467873  | 282888   | 464999  | 461298  | 486828  |
| 50 SENDA DRD                     | 14        | 486412  |   |  |   |   |   |
| 50 SENDA R DRD 2003->2004        | 6         | 287550  | 467873  | 282888   | 464999  | 461298  | 486828  |
| 50 SENDA R DRD 2005->            | 6         | 287550  | 467873  | 282888   | 464999  | 461298  | 486828  |
| 50 SENDA R/X-TREME 1994->2004    | 6         | 287550  | 467873  | 282888   | 464999  | 461298  | 486828  |
| 50 SENDA SM DRD   X-TREME 2005-> | 6         | 287550  | 467873  | 282888   | 464999  | 461298  | 486828  |
| 50 SENDA SM/X-TREME 1999->2004   | 6         | 287550  | 467873  | 282888   | 464999  | 461298  | 486828  |
| 50 SENDA SM DRD 2003->2004       | 6         | 287550  | 467873  | 282888   | 464999  | 461298  | 486828  |
| 125 GPR 1996->                   | 4         | 297705  | 467878  |  |   |   |   |
| 125 GPR 2004->2006               | 6         | 287550  | 467873  | 282888   | 464999  | 461298  | 486828  |
| 125 GPR 2009                     | 24        |   | 479778  |  | 484831  |   |   |
| 125 SENDA DRD                    | 14        | 450529  | 467879  | 294395   |   |   | 486834  |
| 125 SENDA DRD PRO                | 18        | 452068  | 467885  | 482452   |   |   | 486836  |

# PLAQUETTE DE FREIN - MÂCHOIRE DE FREIN / BRAKE PAD - BRAKE SHOE

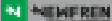
|                            | N° schéma |  |  |  |  |  |  |
|----------------------------|-----------|---|---|--|---|---|---|
| <b>FANTIC</b>              |           |   |   |  |   |   |   |
| Arrière                    |           |   |   |  |   |   |   |
| 50 GRINTA 1995->1996       | 22        | 494372  |   |  |   |   |   |
| <b>FYM</b>                 |           |   |   |  |   |   |   |
| Avant                      |           |   |   |  |   |   |   |
| 125 FYM                    | 69        | 362881  | 481919  | 482454   |   |   |   |
| <b>GENERIC</b>             |           |   |   |  |   |   |   |
| Avant                      |           |   |   |  |   |   |   |
| TIGGER 2006->              | 3         | 3374  |   | 173506   | 464996  | 461297  |   |
| TIGGER 2006->              | 37        |   | 485503  |  |   |   | 486829  |
| <b>HONDA</b>               |           |   |   |  |   |   |   |
| Avant                      |           |   |   |  |   |   |   |
| 50 SFX                     | 3         | 3374  |   | 173506   | 464996  | 461297  |   |
| 50 X8R S/X                 | 3         | 3374  |   | 173506   | 464996  | 461297  |   |
| 125 FORZA 2014->           | 34        | 482072  | 494599  |  |   |   | 486844  |
| 125 PANTHEON               | 53        | 450524  |   |  |   |   |   |
| 125 PCX 2014->2015         | 59        | 492560  | 485292  |  |   |   | 486846  |
| 125 SH 2013->              | 46        | 481796  | 490590  |  |   |   | 486838  |
| 125 SH 2014->2015          | 59        | 492560  | 485292  |  |   |   | 486846  |
| 150 FORZA 2014->           | 34        | 482072  | 494599  |  |   |   | 486844  |
| 250 JAZZ                   | 53        | 450524  |   |  |   |   |   |
| 400 SILVER WING 2006->     | 34        | 482072  | 494599  |  |   |   | 486844  |
| 600 SILVER WING            | 53        | 450524  |   |  |   |   |   |
| 750 INTEGRA 2014->         | 34        | 482072  | 494599  |  |   |   | 486844  |
| SILVER WING                | 54        |   | 490592  |  |   |   |   |
| 750 INTEGRA 2014->         | 67        | 495994  |   |  |   |   |   |
| SILVER WING                | 33        |   | 490592  |  |   |   |   |
| Arrière                    |           |   |   |  |   |   |   |
| 50 PXR tous modèles 1985-> | S         | 498275  |   |  |   |   |   |
| 125 CBR 2004->             | 52        |   | 483105  |  |   |   |   |
| 125 FORZA 2014->           | 67        | 495999  | 490591  |  |   |   |   |
| 125 PCX                    | 0         |   | 485293  |  |   |   |   |
| 125 SH 2000->2009          | 0         |   | 485293  |  |   |   |   |
| 125 S-WING 2007->          | 67        | 495999  | 490591  |  |   |   |   |
| 125 VARADERO->2001         | 52        |   | 483105  |  |   |   |   |
| 150 FORZA 2009->2012       | 67        | 495999  | 490591  |  |   |   |   |
| 150 FORZA 2014->           | 67        | 495999  | 490591  |  |   |   |   |
| 150 S-WING 2008->          | 67        | 495999  | 490591  |  |   |   |   |
| 250 FORZA 2005->           | 67        | 495999  | 490591  |  |   |   |   |
| 250 JAZZ 2005->            | 67        | 495999  | 490591  |  |   |   |   |
| 300 FORZA 2007->           | 67        | 495999  | 490591  |  |   |   |   |
| 400 SILVER WING FJS 2006-> | 44        |   | 494597  |  |   |   |   |
| 400 SWT 2009->             | 44        |   | 494597  |  |   |   |   |
| SILVER WING                | 67        | 495999  | 490591  |  |   |   |   |

# PLAQUETTE DE FREIN - MÂCHOIRE DE FREIN / BRAKE PAD - BRAKE SHOE

|                               | N° schéma |  |  |  |  |  |  |
|-------------------------------|-----------|---|---|--|---|---|---|
| <b>ITAL JET</b>               |           |   |   |  |   |   |   |
| <b>Avant</b>                  |           |   |   |  |   |   |   |
| DRAGSTER 1999->               | 6         | 287550  | 467873  | 282888   | 464999  | 461298  | 486828  |
| FORMULA 1995->                | 6         | 287550  | 467873  | 282888   | 464999  | 461298  | 486828  |
| <b>Arrière</b>                |           |   |   |  |   |   |   |
| 125   150 MILLENIUM 2001->    | 29        | 465386  | 485291  |  |   |   |   |
| 250 JUPITER 2000->            | 29        | 465386  | 485291  |  |   |   |   |
| <b>KAWAZAKI</b>               |           |   |   |  |   |   |   |
| <b>Avant</b>                  |           |   |   |  |   |   |   |
| 300J                          | 42        | 452075  | 490593  |  |   |   |   |
| <b>Arrière</b>                |           |   |   |  |   |   |   |
| 125 J 2016                    | 64        |   | 494598  |  |   |   |   |
| 300 J                         | 43        |   | 490594  |  |   |   |   |
| <b>KEEWAY</b>                 |           |   |   |  |   |   |   |
| <b>Avant</b>                  |           |   |   |  |   |   |   |
| 50   125 TX                   | 29        | 465386  | 485291  |  |   |   |   |
| 50 FOCUS 2006->               | 19        |   | 483108  | 482450   |   |   |   |
| 50 MATRIX 2006->              | 19        |   | 483108  | 482450   |   |   |   |
| 50 MATRIX RACING SPORT 2010-> | 19        |   | 483108  | 482450   |   |   |   |
| 50 RY8 2007->                 | 19        |   | 483108  | 482450   |   |   |   |
| 125   150 OUTLOOK 2007->2010  | 33        | 494261  | 479779  |  |   |   |   |
| 125 FOCUS 2006->              | 19        |   | 483108  | 482450   |   |   |   |
| 125 MATRIX SPORT 2010->       | 19        |   | 483108  | 482450   |   |   |   |
| 150 MATRIX 2006->             | 19        |   | 483108  | 482450   |   |   |   |
| <b>Arrière</b>                |           |   |   |  |   |   |   |
| 50 RY8 2010->                 | 38        | 486411  |   | 482453   |   |   |   |
| 50 RY8                        | 38        | 486411  |   | 482453   |   |   |   |
| 125   150 OUTLOOK 2007->2010  | 33        | 494261  | 479779  |  |   |   |   |
| <b>KYMCO</b>                  |           |   |   |  |   |   |   |
| <b>Avant</b>                  |           |   |   |  |   |   |   |
| 50 PEOPLE 1999->              | 26        |   | 483107  |  |   |   |   |
| 50 AGILITY 10" 12"            | 70        | 297098  |   | 282854   | 465004  |   | 486831  |
| 50 AGILITY 2005->2008         | 31        | 465384  | 467890  | 467647   |   |   |   |
| 50 AGILITY 2008->             | 26        |   | 483107  |  |   |   |   |
| 50 B&W 1999->                 | 31        | 465384  | 467890  | 467647   |   |   |   |
| 50 B&W 2004->                 | 31        | 465384  | 467890  | 467647   |   |   |   |
| 50 DINK                       | 70        | 297098  |   | 282854   | 465004  |   | 486831  |
| 50 DINK 1999->                | 31        | 465384  | 467890  | 467647   |   |   |   |
| 50 DINK 4 temps 2007->        | 31        | 465384  | 467890  | 467647   |   |   |   |
| 50 KYMCO AGILITY 10" 12"      | 32        | 297083  |   |  |   |   |   |
| 50 SPACER 1999->              | 31        | 465384  | 467890  | 467647   |   |   |   |
| 50 SUPER 9 2002->             | 31        | 465384  | 467890  | 467647   |   |   |   |
| 50 VITALITY                   | 70        | 297098  |   | 282854   | 465004  |   | 486831  |
| 50 YAGER 2001->               | 31        | 465384  | 467890  | 467647   |   |   |   |

## PLAQUETTE DE FREIN - MÂCHOIRE DE FREIN / BRAKE PAD - BRAKE SHOE

N° schéma







## KYMCO

## Avant







|                               |    |        |        |        |  |  |
|-------------------------------|----|--------|--------|--------|--|--|
| 100 COBRA 1999->              | 31 | 465384 | 467890 | 467647 |  |  |
| 125 DOWNTOWN I 2009->2015     | 44 |        | 494597 |        |  |  |
| 125 DOWNTOWN 2010->2014       | 45 | 492561 |        |        |  |  |
| 125 PEOPLE 1999->             | 26 |        | 483107 |        |  |  |
| 125 PEOPLE 2010->             | 47 | 452073 |        |        |  |  |
| 125 AGILITY 2006->2008        | 33 | 494261 | 479779 |        |  |  |
| 125 AGILITY R 12 2006->2014   | 33 | 494261 | 479779 |        |  |  |
| 125 AGILITY RS 2006->2010     | 33 | 494261 | 479779 |        |  |  |
| 125 B&W 1999->                | 31 | 465384 | 467890 | 467647 |  |  |
| 125 DINK 1996->               | 31 | 465384 | 467890 | 467647 |  |  |
| 125 DINK 2006->2007           | 31 | 465384 | 467890 | 467647 |  |  |
| 125 DINK STREET 2009->2015    | 45 | 492561 |        |        |  |  |
| 125 GRAND DINK                | 31 | 465384 | 467890 | 467647 |  |  |
| 125 MOVIE 1999->              | 31 | 465384 | 467890 | 467647 |  |  |
| 125 PULSAR 2001->             | 31 | 465384 | 467890 | 467647 |  |  |
| 125 SPACER 1999->             | 31 | 465384 | 467890 | 467647 |  |  |
| 125 VIVIO 2001->2003          | 33 | 494261 | 479779 |        |  |  |
| 125 YAGER 2001->              | 31 | 465384 | 467890 | 467647 |  |  |
| 150 VIVIO 2001->2014          | 33 | 494261 | 479779 |        |  |  |
| 200 DINK 2004->               | 31 | 465384 | 467890 | 467647 |  |  |
| 200 DOWNTOWN 2010->2014       | 45 | 492561 |        |        |  |  |
| 200 DOWNTOWN I 2010->         | 44 |        | 494597 |        |  |  |
| 200 LIKE 2010                 | 33 | 494261 | 479779 |        |  |  |
| 200 PEOPLE 2010->             | 47 | 452073 |        |        |  |  |
| 250 B&W 2001->                | 31 | 465384 | 467890 | 467647 |  |  |
| 250 PEOPLE 2006->2014         | 33 | 494261 | 479779 |        |  |  |
| 300 DOWNTOWN 2010->2014       | 45 | 492561 |        |        |  |  |
| 300 DOWNTOWN ABS 2010->2011   | 44 |        | 494597 |        |  |  |
| 300 DOWNTOWN I 2009->2011     | 44 |        | 494597 |        |  |  |
| 300 DOWNTOWN I ABS 2010->2011 | 44 |        | 494597 |        |  |  |
| 300 PEOPLE 2008->2014         | 33 | 494261 | 479779 |        |  |  |
| 300 PEOPLE GTI 2010->2014     | 45 | 492561 |        |        |  |  |
| 300 XCITING 2008->2009        | 45 | 492561 |        |        |  |  |







## Arrière

|                           |    |        |        |        |        |  |
|---------------------------|----|--------|--------|--------|--------|--|
| 50 AGILITY (machoire x2)  | R  |        | 484936 | 836    | 493268 |  |
| 50 SUPER 9 2000->2001     | 26 |        | 483107 |        |        |  |
| 125 DINK 1996->           | 31 | 465384 | 467890 | 467647 |        |  |
| 125 DOWNTOWN 2016->       | 64 |        | 494598 |        |        |  |
| 125 DOWNTOWN I 2009->2015 | 64 |        | 494598 |        |        |  |
| 125 GRAND DINK            | 31 | 465384 | 467890 | 467647 |        |  |
| 125 SPACER 1999->         | 31 | 465384 | 467890 | 467647 |        |  |
| 125 SUPER DINK 2010->     | 64 |        | 494598 |        |        |  |
| 125 X-TOWN 2016           | 64 |        | 494598 |        |        |  |
| 125 YAGER 2001->          | 31 | 465384 | 467890 | 467647 |        |  |
| 200 DINK 2004->           | 31 | 465384 | 467890 | 467647 |        |  |







# PLAQUETTE DE FREIN - MÂCHOIRE DE FREIN / BRAKE PAD - BRAKE SHOE

|  | N° schéma |  |  |  |  |  |  |
|--|-----------|---|---|--|---|---|---|
| <b>KYMCO</b>                                 |           |   |   |  |   |   |   |
| <b>Arrière</b>                               |           |   |   |  |   |   |   |
| 200 DOWNTOWN I 2010->                        | 64        |   | 494598  |  |   |   |   |
| 200 PEOPLE GTI 2010->                        | 64        |   | 494598  |  |   |   |   |
| 250 B&W 2001->                               | 31        | 465384  | 467890  | 467647   |   |   |   |
| 300 DOWNTOWN ABS 2010->2011                  | 64        |   | 494598  |  |   |   |   |
| 300 DOWNTOWN I 2009->2011                    | 64        |   | 494598  |  |   |   |   |
| 300 PEOPLE GTI 300 ABS 2012                  | 64        |   | 494598  |  |   |   |   |
| 300 X-TOWN 2016                              | 64        |   | 494598  |  |   |   |   |
| 350 DOWNTOWN 2016                            | 64        |   | 494598  |  |   |   |   |
| 500 X-CITING->2005                           | 43        |   | 490594  |  |   |   |   |
| <b>MALAGUTI</b>                              |           |   |   |  |   |   |   |
| <b>Avant</b>                                 |           |   |   |  |   |   |   |
| 50 F10 1994->                                | 3         | 3374  |   | 173506   | 464996  | 461297  |   |
| 50 F12 (machoire x2)                         | A         |   | 484758  | 4246   | 493269  |   | 486848  |
| 50 F12   F15                                 | 3         | 3374  |   | 173506   | 464996  | 461297  |   |
| 50 F12 1994->1998                            | 12        | 168663  | 467872  |  |   |   |   |
| 50 F12 2007->2010                            | 8         | 297136  | 467871  | 282840   | 464997  | 461299  | 486830  |
| 50 F12 PHANTOM LC 1994->1998                 | 12        | 168663  | 467872  |  |   |   |   |
| 50 F12 PHANTOM LC 1999->                     | 3         | 3374  |   | 173506   | 464996  | 461297  |   |
| 50 F15 FIRE FOX   LC 2000->                  | 3         | 3374  |   | 173506   | 464996  | 461297  |   |
| 50 F15 FIRE FOX LC 1996->1999                | 12        | 168663  | 467872  |  |   |   |   |
| 50 YESTERDAY 1997->                          | 3         | 3374  |   | 173506   | 464996  | 461297  |   |
| 125   160 BLOG 2010->2014                    | 33        | 494261  | 479779  |  |   |   |   |
| 125   160 CENTRO 2008->2014                  | 33        | 494261  | 479779  |  |   |   |   |
| 250   400 MADISON                            | 50        | 452066  |   |  |   |   |   |
| <b>Arrière</b>                               |           |   |   |  |   |   |   |
| 50 F12 2007->2010                            | 8         | 297136  | 467871  | 282840   | 464997  | 461299  | 486830  |
| 125   150   180   200   250   400<br>MADISON | 7         | 450526  |   |  |   |   |   |
| <b>MBK   YAMAHA</b>                          |           |   |   |  |   |   |   |
| <b>Avant</b>                                 |           |   |   |  |   |   |   |
| 50 BOOSTER NEXT GENERATION<br>1996->         | 1         |   | 467870  |  |   |   | 486826  |
| 50 BOOSTER NG   BW'S NG 1995->               | 3         | 3374  |   | 173506   | 464996  | 461297  |   |
| 50 BOOSTER R 1994->                          | 1         |   | 467870  |  |   |   | 486826  |
| 50 BOOSTER ROAD   BW'S R<br>1994->1995       | 3         | 3374  |   | 173506   | 464996  | 461297  |   |
| 50 BOOSTER ROCKET   BW'S ROCKET<br>1996->    | 3         | 3374  |   | 173506   | 464996  | 461297  |   |
| 50 BOOSTER SPIRIT   BW'S 1996->              | 3         | 3374  |   | 173506   | 464996  | 461297  |   |
| 50 BOOSTER TRACK   BW'S BUMP<br>1996->       | 3         | 3374  |   | 173506   | 464996  | 461297  |   |
| 50 DODO 2000->                               | 3         | 3374  |   | 173506   | 464996  | 461297  |   |
| 50 DT 2004->                                 | 36        | 362858  | 467875  | 467625   |   |   |   |
| 50 FIZZ 1994->                               | 1         |   | 467870  |  |   |   | 486826  |

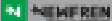





|                                     | N° schéma |  |  |  |  |  |  |
|-------------------------------------|-----------|---|---|--|---|---|---|
| <b>MBK   YAMAHA</b>                 |           |   |   |  |   |   |   |
| <b>Avant</b>                        |           |   |   |  |   |   |   |
| 50 FLIPPER   WHY 1998->             | 3         | 3374  |   | 173506   | 464996  | 461297  |   |
| 50 FORTE 1995->                     | 1         |   | 467870  |  |   |   | 486826  |
| 50 MACH G 2002->                    | 3         | 3374  |   | 173506   | 464996  | 461297  |   |
| 50 MOBILETTE ciclomotori            | T         | 498276  |   |  |   |   |   |
| 50 NEXT 1996->                      | 3         | 3374  |   | 173506   | 464996  | 461297  |   |
| 50 NITRO                            | 3         | 3374  |   | 173506   | 464996  | 461297  |   |
| 50 NITRO 1997->                     | 1         |   | 467870  |  |   |   | 486826  |
| 50 OVETTO 2000->                    | 1         |   | 467870  |  |   |   | 486826  |
| 50 ROCKET 1996->                    | 3         | 3374  |   | 173506   | 464996  | 461297  |   |
| 50 STUNT   SLIDER 1999->            | 8         | 297136  | 467871  | 282840   | 464997  | 461299  | 486830  |
| 50 TZR   X POWER                    | 70        | 297098  |   | 282854   | 465004  |   | 486831  |
| 50 X-LIMIT   DT 50 R 1998->2003     | 12        | 168663  | 467872  |  |   |   |   |
| 50 X-LIMIT 2004->                   | 6         | 287550  | 467873  | 282888   | 464999  | 461298  | 486828  |
| 50 X-POWER   TZR 50 1998->2003      | 32        | 297083  |   |  |   |   |   |
| 50 X-POWER   TZR 50 2004->          | 36        | 362858  | 467875  | 467625   |   |   |   |
| 50 X-POWER   TZR 50 2004->          | 6         | 287550  | 467873  | 282888   | 464999  | 461298  | 486828  |
| 100 BOOSTER                         | 69        | 362881  | 481919  | 482454   |   |   |   |
| 125   150 DOODO   THEOS 2001->      | 3         | 3374  |   | 173506   | 464996  | 461297  |   |
| 125   250 X-MAX 2006->2009          | 49        | 468270  | 479514  |  |   |   | 486842  |
| 125 CITYLINER 2008->                | 34        | 482072  | 494599  |  |   |   | 486844  |
| 125 EVOLIS 2010->                   | 46        | 481796  | 490590  |  |   |   | 486838  |
| 125 FLAME   CYGNUS 1996->2003       | 70        | 297098  |   | 282854   | 465004  |   | 486831  |
| 125 FLAME X   CYGNUS X 2004->       | 39        | 297155  | 467888  | 467634   |   |   | 486837  |
| 125 MAJESTY 1998->                  | 48        | 441465  | 467882  | 482451   |   |   | 486833  |
| 125 S D'LIGHT 2014->                | 58        | 495992  |   |  |   |   |   |
| 125 SKYCRUISER 2006->2009           | 49        | 468270  | 479514  |  |   |   | 486842  |
| 125 SKYCRUISER 2010->               | 46        | 481796  | 490590  |  |   |   | 486838  |
| 125 SKYLINER   MAJESTY 1998->       | 48        | 441465  | 467882  | 482451   |   |   | 486833  |
| 125 THUNDER                         | 48        | 441465  | 467882  | 482451   |   |   | 486833  |
| 125 TRICITY                         | 55        | 494459  |   |  |   |   |   |
| 125 TRICITY 2014->                  | 56        | 492562  |   |  |   |   |   |
| 125 TRYPTIK                         | 55        | 494459  |   |  |   |   |   |
| 125 TRYPTIK 2014->                  | 56        | 492562  |   |  |   |   |   |
| 125 VITY 2008->                     | 58        | 495992  |   |  |   |   |   |
| 125 WAAP                            | 58        | 495992  |   |  |   |   |   |
| 125 X-CITY 2008->                   | 34        | 482072  | 494599  |  |   |   | 486844  |
| 125 X-LIMIT                         | 36        | 362858  | 467875  | 467625   |   |   |   |
| 125 X-LIMIT 2004->                  | 19        | 452068  | 467885  | 482452   |   |   | 486836  |
| 125 X-MAX                           | 48        | 441465  | 467882  | 482451   |   |   | 486833  |
| 125 X-MAX 2010->2011                | 46        | 481796  | 490590  |  |   |   | 486838  |
| 125 X-MAX ABS 2011->                | 46        | 481796  | 490590  |  |   |   | 486838  |
| 125 YZF 2008->                      | 48        | 441465  | 467882  | 482451   |   |   | 486833  |
| 150   180 SKYLINER   MAJESTY 2002-> | 48        | 441465  | 467882  | 482451   |   |   | 486833  |
| 250 R X-MAX 2010->                  | 34        | 482072  | 494599  |  |   |   | 486844  |







# PLAQUETTE DE FREIN - MÂCHOIRE DE FREIN / BRAKE PAD - BRAKE SHOE

|   | N° schéma |  |  |  |  |  |  |
|---|-----------|---|---|--|---|---|---|
| <b>MBK   YAMAHA</b>                                   |           |   |   |  |   |   |   |
| <b>Avant</b>  |           |   |   |  |   |   |   |
| 250 SKYLINER   MAJESTY 2001 ->                        | 63        | 465380  | 467874  |  |   |   | 486843  |
| 250 X-CITY 2007->                                     | 34        | 482072  | 494599  |  |   |   | 486844  |
| 250 X-MAX 2005->                                      | 49        | 468270  | 479514  |  |   |   | 486842  |
| 300 VERSITY 2006->                                    | 34        | 482072  | 494599  |  |   |   | 486844  |
| 400 SKYLINER   MAJESTY 2004->                         | 63        | 465380  | 467874  |  |   |   | 486843  |
| 500 T-MAX 2001->2003                                  | 62        | 450525  |   |  |   |   |   |
| 500 T-MAX 2004->                                      | 63        | 465380  | 467874  |  |   |   | 486843  |
| 500 T-MAX 2008->                                      | 20        | 492566  | 490595  |  |   |   |   |
| 530 T-MAX   | 20        | 492566  | 490595  |  |   |   |   |
| CYCLO 41 MBK (machoire x2)                            | B         |   |   | 833  | 493266  |   |   |
| CYCLO 51 Ø80x20 (machoire x2)                         | B         |   |   | 833  | 493266  |   |   |
| CYCLO 51 S Bernardi Ø90 (machoire x2)                 | C         |   |   | 292877   |   |   |   |
| CYCLO Ø90 ressort en u, roue batons alu (machoire x2) | D         |   | 492541  | 479094   | 493265  |   |   |
| <b>Arrière</b>  |           |   |   |  |   |   |   |
| 50 BOOSTER (machoire x2)                              | A         |   | 484758  | 4246   | 493269  |   | 486848  |
| 50 DT R 2004->  | 18        | 452068  | 467885  | 482452   |   |   | 486836  |
| 50 EVASION  | S         | 498275  |   |  |   |   |   |
| 50 HARDROCK   | S         | 498275  |   |  |   |   |   |
| 50 MAGNUM   | S         | 498275  |   |  |   |   |   |
| 50 NITRO   AEROX 1997->                               | 8         | 297136  | 467871  | 282840   | 464997  | 461299  | 486830  |
| 50 OVETTO (machoire x2)   NEOS                        | A         |   | 484758  | 4246   | 493269  |   | 486848  |
| 50 PASSION  | S         | 498275  |   |  |   |   |   |
| 50 ROCKET (machoire x2)                               | A         |   | 484758  | 4246   | 493269  |   | 486848  |
| 50 STUNT (machoire x2)   SLIDER                       | A         |   | 484758  | 4246   | 493269  |   | 486848  |
| 50 X-LIMIT 2004->                                     | 6         | 287550  | 467873  | 282888   | 464999  | 461298  | 486828  |
| 50 X-LIMIT 2004->                                     | 18        | 452068  | 467885  | 482452   |   |   | 486836  |
| 50 X-LIMIT  | 23        | 839   |   |  |   |   |   |
| 50 X-POWER   TZR 50 1998->2003                        | 70        | 297098  |   | 282854   | 465004  |   | 486831  |
| 50 X-POWER   TZR 50 2004->                            | 6         | 287550  | 467873  | 282888   | 464999  | 461298  | 486828  |
| 50 X-POWER 2004->                                     | 6         | 287550  | 467873  | 282888   | 464999  | 461298  | 486828  |
| 125 CYGNUS 2004->                                     | E         |   | 490599  |  |   |   |   |
| 125 FLAME 2004->                                      | E         |   | 490599  |  |   |   |   |
| 125 CYGNUS ->2003                                     | F         |   | 490602  |  |   |   |   |
| 125 FLAME ->2003                                      | F         |   | 490602  |  |   |   |   |
| 125 MAJESTY   | G         |   | 490598  |  |   |   |   |
| 125   150   180 SKYLINER   MAJESTY                    | 14        | 450529  | 467879  | 294395   |   |   | 486834  |
| 125 SKYLINER 2002->                                   | 14        | 450529  | 467879  | 294395   |   |   | 486834  |
| 125 SLYLINER ->2001                                   | G         |   | 490598  |  |   |   |   |
| 125 TRICITY   | 51        | 492563  |   |  |   |   |   |
| 125 TRYPTIK   | 51        | 492563  |   |  |   |   |   |
| 125 TZR 1991->  | 2         |   | 467877  |  |   |   |   |
| 125 X-MAX 2006->2011                                  | 14        | 450529  | 467879  | 294395   |   |   | 486834  |
| 125 X-MAX ABS 2011->                                  | 65        | 481795  |   |  |   |   | 486832  |







|   | N° schéma |        |        |        |        |        |        |
|---|-----------|--------|--------|--------|--------|--------|--------|
| <b>MBK   YAMAHA</b>                                   |           |        |        |        |        |        |        |
| <b>Arrière</b>  |           |        |        |        |        |        |        |
| 150 SKYLINER 2002->                                   | 14        | 450529 | 467879 | 294395 |        |        | 486834 |
| 250 SKYLINER   MAJESTY 2001->                         | 66        | 465381 |        |        |        |        |        |
| 250 X-MAX 2005->                                      | 66        | 465381 |        |        |        |        |        |
| 300 KILIBRE   VERSITY 2003->                          | 48        | 441465 | 467882 | 482451 |        |        | 486833 |
| 400 SKYLINER   MAJESTY 2004->                         | 60        | 465387 | 467883 |        |        |        | 486840 |
| 500 T-MAX 2001->2003                                  | 61        | 465392 | 490596 |        |        |        |        |
| 500 T-MAX 2004->                                      | 60        | 465387 | 467883 |        |        |        | 486840 |
| 500 T-MAX 2012->                                      | 28        | 492564 |        |        |        |        |        |
| 530 T-MAX 2012->2016                                  | 61        | 465392 | 490596 |        |        |        |        |
| CYCLO 41 MBK (machoire x2)                            | B         |        |        | 833    | 493266 |        |        |
| CYCLO 51 Ø80x20 (machoire x2)                         | B         |        |        | 833    | 493266 |        |        |
| CYCLO 51 S Bernardi Ø90 (machoire x2)                 | C         |        |        | 292877 |        |        |        |
| CYCLO 88/89 Ø100 (machoire x2)                        | H         |        |        | 481759 |        |        |        |
| CYCLO Ø90 ressort en u, roue batons alu (machoire x2) | D         |        | 492541 | 479094 | 493265 |        |        |
| <b>PEUGEOT</b>  |           |        |        |        |        |        |        |
| <b>Avant</b>  |           |        |        |        |        |        |        |
| 50   125 TWEET  | 34        | 482072 | 494599 |        |        |        | 486844 |
| 50 BLASTER 2009->                                     | 6         | 287550 | 467873 | 282888 | 464999 | 461298 | 486828 |
| 50 BUXY 1994->  | 3         | 3374   |        | 173506 | 464996 | 461297 |        |
| 50 BUXY AJP 1994->                                    | 6         | 287550 | 467873 | 282888 | 464999 | 461298 | 486828 |
| 50 BUXY RS 1994->                                     | 25        | 297117 | 467876 | 282873 | 464998 |        | 486839 |
| 50 CTECK 2009->                                       | 6         | 287550 | 467873 | 282888 | 464999 | 461298 | 486828 |
| 50 DJANGO   | 42        | 452075 | 490593 |        |        |        |        |
| 50 ELYSEO 1998->                                      | 6         | 287550 | 467873 | 282888 | 464999 | 461298 | 486828 |
| 50 ELYSTAR 2003->2005                                 | 6         | 287550 | 467873 | 282888 | 464999 | 461298 | 486828 |
| 50 JET FORCE 2003->                                   | 6         | 287550 | 467873 | 282888 | 464999 | 461298 | 486828 |
| 50 KISBEE   | 25        | 297117 | 467876 | 282873 | 464998 |        | 486839 |
| 50 KISBEE->2010                                       | 6         | 287550 | 467873 | 282888 | 464999 | 461298 | 486828 |
| 50 LOOXOR 2002->                                      | 6         | 287550 | 467873 | 282888 | 464999 | 461298 | 486828 |
| 50 LUDIX  | 25        | 297117 | 467876 | 282873 | 464998 |        | 486839 |
| 50 LUDIX 2004->                                       | 6         | 287550 | 467873 | 282888 | 464999 | 461298 | 486828 |
| 50 METAL-X 2003->                                     | 6         | 287550 | 467873 | 282888 | 464999 | 461298 | 486828 |
| 50 NK7  | 24        |        | 479778 |        | 484831 |        |        |
| 50 NK7 2008->   | 21        |        | 483106 |        |        |        |        |
| 50 RUNNER   STALKER                                   | 1         |        | 467870 |        |        |        | 486826 |
| 50 SPEEDAKE AJP 1994                                  | 6         | 287550 | 467873 | 282888 | 464999 | 461298 | 486828 |
| 50 SPEEDAKE HENG TONG 1995->                          | 3         | 3374   |        | 173506 | 464996 | 461297 |        |
| 50 SPEEDFAKE  | 25        | 297117 | 467876 | 282873 | 464998 |        | 486839 |
| 50 SPEEDFIGHT 1997->1998                              | 6         | 287550 | 467873 | 282888 | 464999 | 461298 | 486828 |
| 50 SPEEDFIGHT 2 2001->                                | 6         | 287550 | 467873 | 282888 | 464999 | 461298 | 486828 |
| 50 SPEEDFIGHT 3                                       | 38        | 486411 |        | 482453 |        |        |        |







# PLAQUETTE DE FREIN - MÂCHOIRE DE FREIN / BRAKE PAD - BRAKE SHOE

|                                       | N° schéma |  |  |  |  |  |  |
|---------------------------------------|-----------|---|---|--|---|---|---|
| <b>PEUGEOT</b>                        |           |   |   |  |   |   |   |
| <b>Avant</b>                          |           |   |   |  |   |   |   |
| 50 SPEEDFIGHT LC AJP 1996->           | 6         | 287550  | 467873  | 282888   | 464999  | 461298  | 486828  |
| 50 SQUAB AJP 1996->                   | 6         | 287550  | 467873  | 282888   | 464999  | 461298  | 486828  |
| 50 SQUAB HENGTONG 1996->              | 25        | 297117  | 467876  | 282873   | 464998  |   | 486839  |
| 50 SV                                 | 23        | 839   |   |  |   |   |   |
| 50 TKR 2005->                         | 6         | 287550  | 467873  | 282888   | 464999  | 461298  | 486828  |
| 50 TKR STREET ZONE   WRC 2003->       | 6         | 287550  | 467873  | 282888   | 464999  | 461298  | 486828  |
| 50 TREKKER                            | 25        | 297117  | 467876  | 282873   | 464998  |   | 486839  |
| 50 TREKKER METAL X 2001->             | 6         | 287550  | 467873  | 282888   | 464999  | 461298  | 486828  |
| 50 TREKKER ROAD 1998->                | 6         | 287550  | 467873  | 282888   | 464999  | 461298  | 486828  |
| 50 TWEET   RS 2010->2013              | 34        | 482072  | 494599  |  |   |   | 486844  |
| 50 TWEET EVO   RS 2014->              | 34        | 482072  | 494599  |  |   |   | 486844  |
| 50 V-CLIC 2008->                      | 69        | 362881  | 481919  | 482454   |   |   |   |
| 50 VIVACITY 1998->2007                | 6         | 287550  | 467873  | 282888   | 464999  | 461298  | 486828  |
| 50 VIVACITY 2010->                    | 9         | 465388  |   | 467649   |   |   |   |
| 50 VIVACITY 3                         | 35        | 465383  | 467886  |  | 478071  |   | 486835  |
| 50 VIVACITY AJP 1999->                | 6         | 287550  | 467873  | 282888   | 464999  | 461298  | 486828  |
| 50 VIVACITY HENGTONG 2005->           | 25        | 297117  | 467876  | 282873   | 464998  |   | 486839  |
| 50 X FIGHT 2000->                     | 6         | 287550  | 467873  | 282888   | 464999  | 461298  | 486828  |
| 50 XP6   XP7                          | 27        |   |   | 483815   |   |   |   |
| 50 XP6 1998->2003                     | 6         | 287550  | 467873  | 282888   | 464999  | 461298  | 486828  |
| 50 XP6 2003->                         | 36        | 362858  | 467875  | 467625   |   |   |   |
| 50 XP6 2004->                         | 6         | 287550  | 467873  | 282888   | 464999  | 461298  | 486828  |
| 50 XPS ENDURO 2004->                  | 6         | 287550  | 467873  | 282888   | 464999  | 461298  | 486828  |
| 50 XR6 2002->2007                     | 39        | 297155  | 467888  | 467634   |   |   | 486837  |
| 50 XR7                                | 24        |   | 479778  |  | 484831  |   |   |
| 50 XR7                                | 21        |   | 483106  |  |   |   |   |
| 50 ZENITH HENGTONG 1996->             | 25        | 297117  | 467876  | 282873   | 464998  |   | 486839  |
| 50 ZENITH LN   LS 1997->              | 6         | 287550  | 467873  | 282888   | 464999  | 461298  | 486828  |
| 100 ELYSEO                            | 6         | 287550  | 467873  | 282888   | 464999  | 461298  | 486828  |
| 100 LOOXOR 2003->                     | 6         | 287550  | 467873  | 282888   | 464999  | 461298  | 486828  |
| 100 SPEEDFIGHT                        | 25        | 297117  | 467876  | 282873   | 464998  |   | 486839  |
| 100 SPEEDFIGHT 2 FURIOUS   WRC 2003-> | 6         | 287550  | 467873  | 282888   | 464999  | 461298  | 486828  |
| 100 SPEEDFIGHT AJP 1997->             | 6         | 287550  | 467873  | 282888   | 464999  | 461298  | 486828  |
| 100 TREKKER ROAD 1998->               | 6         | 287550  | 467873  | 282888   | 464999  | 461298  | 486828  |
| 100 VIVACITY AJP 1999->               | 6         | 287550  | 467873  | 282888   | 464999  | 461298  | 486828  |
| 125   150 ELYSEO 2001->               | 36        | 362858  | 467875  | 467625   |   |   |   |
| 125   150 LOOXOR 2003->               | 50        | 452066  |   |  |   |   |   |
| 125 ELYSEO 2000->                     | 36        | 362858  | 467875  | 467625   |   |   |   |
| 125 ELYSEO AJP 1998->                 | 6         | 287550  | 467873  | 282888   | 464999  | 461298  | 486828  |
| 125 ELYSTAR 2002->                    | 36        | 362858  | 467875  | 467625   |   |   |   |
| 125 GEOPOLIS 2006->                   | 35        | 465383  | 467886  |  | 478071  |   | 486835  |
| 125 JET FORCE 2003->2004              | 36        | 362858  | 467875  | 467625   |   |   |   |

|   | N° schéma |  |  |  |  |  |  |
|---|-----------|---|---|--|---|---|---|
| <b>PEUGEOT</b>                            |           |   |   |  |   |   |   |
| <b>Avant</b>                              |           |   |   |  |   |   |   |
| 125 LXR 2010->                            | 34        | 482072  | 494599  |  |   |   | 486844  |
| 125 SATELIS 2004->2006                    | 47        | 452073  |   |  |   |   |   |
| 125 SATELIS 2006->                        | 36        | 362858  | 467875  | 467625   |   |   |   |
| 125 SATELIS 2008->2009                    | 33        | 494261  | 479779  |  |   |   |   |
| 125 TWEET 2010->2013                      | 34        | 482072  | 494599  |  |   |   | 486844  |
| 125 TWEET EVO   RS 2014->                 | 34        | 482072  | 494599  |  |   |   | 486844  |
| 125 TWEET RS 2010->2013                   | 34        | 482072  | 494599  |  |   |   | 486844  |
| 125 VIVACITY 2010->2014                   | 33        | 494261  | 479779  |  |   |   |   |
| 150 TWEET   RS 2010->2013                 | 34        | 482072  | 494599  |  |   |   | 486844  |
| 200 LXR 2010->                            | 34        | 482072  | 494599  |  |   |   | 486844  |
| 250   400 GEOPOLIS 2010->                 | 33        | 494261  | 479779  |  |   |   |   |
| 250 GEOPOLIS 2006->2009                   | 33        | 494261  | 479779  |  |   |   |   |
| 250 SATELIS 2006->2010                    | 33        | 494261  | 479779  |  |   |   |   |
| 400 GEOPOLIS 2007->2010                   | 33        | 494261  | 479779  |  |   |   |   |
| 400 METROPOLIS ->2013                     | 28        | 486720  |   |  |   |   |   |
| 400 METROPOLIS 2013->                     | 28        | 492564  |   |  |   |   |   |
| CYCLO 103 FOX   FXR (machoire x2)         | I         |   | 492542  | 449771   |   |   |   |
| CYCLO 103 Grimeca Ø90 (machoire x2)       | D         |   | 492541  | 479094   | 493265  |   |   |
| CYCLO 103 RCX   SPX Ø104x22 (machoire x2) | I         |   | 492542  | 449771   |   |   |   |
| CYCLO RCX Bernardi (machoire x2)          | C         |   |   | 292877   |   |   |   |
| CYCLO 103 SP Ø80x20 (machoire x2)         | B         |   |   | 833  | 493266  |   |   |
| CYCLO 103 SP Ø80x18 (machoire x2)         | K         |   | 492539  |  |   |   | 486849  |
| CYCLO 103 SPX Bernardi (machoire x2)      | C         |   |   | 292877   |   |   |   |
| <b>Arrière</b>                            |           |   |   |  |   |   |   |
| 50 BUXY (machoire x2)                     | R         |   | 484936  | 836  | 493268  |   |   |
| 50 JET FORCE CTEK 2009->                  | 6         | 287550  | 467873  | 282888   | 464999  | 461298  | 486828  |
| 50 ELYSEO                                 | 6         | 287550  | 467873  | 282888   | 464999  | 461298  | 486828  |
| 50 ELYSTAR 2003->2005                     | 18        | 452068  | 467885  | 482452   |   |   | 486836  |
| 50 JET FORCE->2003                        | 6         | 287550  | 467873  | 282888   | 464999  | 461298  | 486828  |
| 50 LOOXOR 2004->                          | 6         | 287550  | 467873  | 282888   | 464999  | 461298  | 486828  |
| 50 LUDIX (machoire x2)                    | R         |   | 484936  | 836  | 493268  |   |   |
| 50 NK7                                    | 24        |   | 479778  |  | 484831  |   |   |
| 50 SPEEDFIGHT 1997->1998                  | 6         | 287550  | 467873  | 282888   | 464999  | 461298  | 486828  |
| 50 SPEEDFIGHT 3                           | 14        | 486412  |   |  |   |   |   |
| 50 SPEEDFIGHT II FURIOUS   WRC            | 6         | 287550  | 467873  | 282888   | 464999  | 461298  | 486828  |
| 50 ST RAPIDO                              | S         | 498275  |   |  |   |   |   |
| 50 SX                                     | S         | 498275  |   |  |   |   |   |
| 50 TREKKER (machoire x2)                  | R         |   | 484936  | 836  | 493268  |   |   |
| 50 TWEET                                  | 5         | 362907  | 467887  |  |   |   | 486827  |
| 50 V-CLIC (machoire x2)                   | R         |   | 484936  | 836  | 493268  |   |   |
| 50 VIVACITY (machoire x2)                 | R         |   | 484936  | 836  | 493268  |   |   |
| 50 XP6   XP7                              | 27        |   |   | 483815   |   |   |   |
| 50 XP6 2003->2009                         | 6         | 287550  | 467873  | 282888   | 464999  | 461298  | 486828  |







# PLAQUETTE DE FREIN - MÂCHOIRE DE FREIN / BRAKE PAD - BRAKE SHOE

|   | N° schéma |  |  |  |  |  |  |
|---|-----------|---|---|--|---|---|---|
| <b>PEUGEOT</b>                            |           |   |   |  |   |   |   |
| <b>Arrière</b>                            |           |   |   |  |   |   |   |
| 50 XPS SM   ENDURO 2004->                 | 6         | 287550  | 467873  | 282888   | 464999  | 461298  | 486828  |
| 50 XR6 2002->2007                         | 6         | 287550  | 467873  | 282888   | 464999  | 461298  | 486828  |
| 50 XR7                                    | 24        |   | 479778  |  | 484831  |   |   |
| 50 XR7 2008->                             | 6         | 287550  | 467873  | 282888   | 464999  | 461298  | 486828  |
| 100 ELYSEO                                | 6         | 287550  | 467873  | 282888   | 464999  | 461298  | 486828  |
| 100 LOOXOR                                | 6         | 287550  | 467873  | 282888   | 464999  | 461298  | 486828  |
| 100 SPEEDFIGHT AJP                        | 6         | 287550  | 467873  | 282888   | 464999  | 461298  | 486828  |
| 100 SPEEDFIGHT II FURIOUS   WRC           | 6         | 287550  | 467873  | 282888   | 464999  | 461298  | 486828  |
| 125   150 ELYSEO 2001->                   | 18        | 452068  | 467885  | 482452   |   |   | 486836  |
| 125   150 ELYSTAR 2003->                  | 18        | 452068  | 467885  | 482452   |   |   | 486836  |
| 125   150 LOOXOR 2003->                   | 6         | 287550  | 467873  | 282888   | 464999  | 461298  | 486828  |
| 125   150 SATELIS ABS 2006->              | 18        | 452068  | 467885  | 482452   |   |   | 486836  |
| 125 DJANGO 4 temps 2014->                 | 23        | 839   |   |  |   |   |   |
| 125 JET FORCE 2003->2004                  | 18        | 452068  | 467885  | 482452   |   |   | 486836  |
| 125 SATELIS 2006->                        | 18        | 452068  | 467885  | 482452   |   |   | 486836  |
| 125 SATELIS 2008->2009                    | 33        | 494261  | 479779  |  |   |   |   |
| 125 X-EVO                                 | 16        | 450527  | 467880  |  |   |   | 486841  |
| 250   400 GEOPOLIS 2010->                 | 33        | 494261  | 479779  |  |   |   |   |
| 250 GEOPOLIS 2006->2009                   | 33        | 494261  | 479779  |  |   |   |   |
| 400   500 SATELIS 2007->2010              | 33        | 494261  | 479779  |  |   |   |   |
| 400 GEOPOLIS 2007->2010                   | 33        | 494261  | 479779  |  |   |   |   |
| 400 GEOPOLIS RS 2008->2010                | 33        | 494261  | 479779  |  |   |   |   |
| 400 METROPOLIS->2013                      | 28        | 486720  |   |  |   |   |   |
| CYCLO 103 FOX   FXR (machoire x2)         | I         |   | 492542  | 449771   |   |   |   |
| CYCLO 103 FOX (machoire x2)               | R         |   | 484936  | 836  | 493268  |   |   |
| CYCLO 103 Grimeca Ø90x20 (machoire x2)    | J         |   | 492541  |  | 493265  |   |   |
| CYCLO 103 RCX   SPX Ø104x22 (machoire x2) | I         |   | 492542  | 449771   |   |   |   |
| CYCLO 103 SP Ø80x20 (machoire x2)         | B         |   |   | 833  | 493266  |   |   |
| CYCLO 103 SP Ø80x18 (machoire x2)         | K         |   | 492539  |  |   |   | 486849  |
| CYCLO 103 SPX Bernardi (machoire x2)      | C         |   |   | 292877   |   |   |   |
| <b>PGO</b>                                |           |   |   |  |   |   |   |
| <b>Avant</b>                              |           |   |   |  |   |   |   |
| 50 BIG MAX 1994->2002                     | 69        | 362881  | 481919  | 482454   |   |   |   |
| 50 T-REX 99->                             | 34        | 482072  | 494599  |  |   |   | 486844  |
| <b>PIAGGIO   GILERA</b>                   |           |   |   |  |   |   |   |
| <b>Avant</b>                              |           |   |   |  |   |   |   |
| 50 DNA 2000->GRIMECA                      | 36        | 362858  | 467875  | 467625   |   |   |   |
| 50 DNA 2005->2007                         | 35        | 465383  | 467886  |  | 478071  |   | 486835  |
| 50 FLY 2 temps 2005->2007                 | 35        | 465383  | 467886  |  | 478071  |   | 486835  |
| 50 FLY 4 temps 2005->2010                 | 35        | 465383  | 467886  |  | 478071  |   | 486835  |
| 50 GSM 1999->                             | 6         | 287550  | 467873  | 282888   | 464999  | 461298  | 486828  |

|   | N° schéma |  |  |  |  |  |  |
|---|-----------|---|---|--|---|---|---|
| <b>PIAGGIO   GILERA</b>                         |           |   |   |  |   |   |   |
| <b>Avant</b>                                    |           |   |   |  |   |   |   |
| 50 GSM 2001->                                   | 6         | 287550  | 467873  | 282888   | 464999  | 461298  | 486828  |
| 50 HAK 1999->                                   | 6         | 287550  | 467873  | 282888   | 464999  | 461298  | 486828  |
| 50 ICE 2002->                                   | 3         | 3374  |   | 173506   | 464996  | 461297  |   |
| 50 LIBERTY 1997->                               | 5         | 362907  | 467887  |  |   |   | 486827  |
| 50 LX2/4  | 5         | 362907  | 467887  |  |   |   | 486827  |
| 50 NRG 1994->                                   | 3         | 3374  |   | 173506   | 464996  | 461297  |   |
| 50 NRG MC2                                      | 1         |   | 467870  |  |   |   | 486826  |
| 50 NRG MC2   MC3 1996->                         | 3         | 3374  |   | 173506   | 464996  | 461297  |   |
| 50 NTT  | 1         |   | 467870  |  |   |   | 486826  |
| 50 NTT 1995->                                   | 3         | 3374  |   | 173506   | 464996  | 461297  |   |
| 50 RACING                                       | 33        | 494261  | 479779  |  |   |   |   |
| 50 RUNNER 1997->2006                            | 3         | 3374  |   | 173506   | 464996  | 461297  |   |
| 50 RUNNER 2006->                                | 35        | 465383  | 467886  |  | 478071  |   | 486835  |
| 50 RUNNER SP 2001->2006                         | 3         | 3374  |   | 173506   | 464996  | 461297  |   |
| 50 RUNNER SP 2006->                             | 36        | 362858  | 467875  | 467625   |   |   |   |
| 50 SFERA RST 1995->                             | 11        | 362896  |   |  |   |   |   |
| 50 STALKER 1997->2004                           | 3         | 3374  |   | 173506   | 464996  | 461297  |   |
| 50 TYPHOON 1993->1995                           | 3         | 3374  |   | 173506   | 464996  | 461297  |   |
| 50 TYPHOON 1996->                               | 11        | 362896  |   |  |   |   |   |
| 50 VESPA ET2/4 1997->                           | 5         | 362907  | 467887  |  |   |   | 486827  |
| 50 VESPA LX 2004->(machoire x2)                 | L         |   | 479804  |  | 493267  |   | 486851  |
| 50 ZIP FAST RIDER 1993->1995                    | 3         | 3374  |   | 173506   | 464996  | 461297  |   |
| 50 ZIP FAST RIDER 1996->                        | 5         | 362907  | 467887  |  |   |   | 486827  |
| 50 ZIP FAST SP 1996->                           | 5         | 362907  | 467887  |  |   |   | 486827  |
| 125   180   200 RUNNER 4 temps GRIMECA 2001->   | 36        | 362858  | 467875  | 467625   |   |   |   |
| 125   180   200 RUNNER 4 temps HENG TONG 2001-> | 35        | 465383  | 467886  |  | 478071  |   | 486835  |
| 125   180 RUNNER   SP GRIMECA 2000->            | 36        | 362858  | 467875  | 467625   |   |   |   |
| 125   180 RUNNER   SP HENG TONG 2000->          | 35        | 465383  | 467886  |  | 478071  |   | 486835  |
| 125   180 SUPER HEXAGON HENG TONG               | 35        | 465383  | 467886  |  | 478071  |   | 486835  |
| 125 BEVERLY 2001->                              | 35        | 465383  | 467886  |  | 478071  |   | 486835  |
| 125 FLY 2003->2008                              | 35        | 465383  | 467886  |  | 478071  |   | 486835  |
| 125 HEXAGON                                     | 35        | 465383  | 467886  |  | 478071  |   | 486835  |
| 125 HEXAGON 1998->                              | 35        | 362858  | 467875  | 467625   |   |   |   |
| 125 LIBERTY 1998->                              | 5         | 362907  | 467887  |  |   |   | 486827  |
| 125 LX   LX4 1998->1999                         | 36        | 362858  | 467875  | 467625   |   |   |   |
| 125 MP3   | 35        | 465383  | 467886  |  | 478071  |   | 486835  |
| 125 MP3 2006->2008                              | 5         | 362907  | 467887  |  |   |   | 486827  |
| 125 MP3 IBRIDO 2009->2010                       | 5         | 362907  | 467887  |  |   |   | 486827  |
| 125 MP3 IE 2008->2009                           | 5         | 362907  | 467887  |  |   |   | 486827  |
| 125 RUNNER 1999->2004                           | 36        | 362858  | 467875  | 467625   |   |   |   |



# PLAQUETTE DE FREIN - MÂCHOIRE DE FREIN / BRAKE PAD - BRAKE SHOE

|  | N° schéma |  |  |  |  |  |  |
|--|-----------|---|---|--|---|---|---|
| <b>PIAGGIO   GILERA</b>                        |           |   |   |  |   |   |   |
| <b>Avant</b>                                   |           |   |   |  |   |   |   |
| 125 RUNNER 2002->                              | 35        | 465383  | 467886  |  | 478071  |   | 486835  |
| 125 TYPHOON 1995->                             | 3         | 3374  |   | 173506   | 464996  | 461297  |   |
| 125 VESPA GRAND TURISMO 2003->                 | 36        | 362858  | 467875  | 467625   |   |   |   |
| 125 VESPA PX ARCOBALENO 1981->1997             | U         | 498277  |   |  |   |   |   |
| 125 X7 2008->                                  | 35        | 465383  | 467886  |  | 478071  |   | 486835  |
| 125 X8   | 16        | 450527  | 467880  |  |   |   | 486841  |
| 125 X8 2004->                                  | 35        | 465383  | 467886  |  | 478071  |   | 486835  |
| 125 X9 2001->2003                              | 14        | 450529  | 467879  | 294395   |   |   | 486834  |
| 125 X9 2004-> droit                            | 30        | 465393  |   | 480094   |   |   |   |
| 125 X-EVO                                      | 16        | 450527  | 467880  |  |   |   | 486841  |
| 150 VESPA PX ARCOBALENO 1983->1997             | U         | 498277  |   |  |   |   |   |
| 200 RUNNER SP 1998->                           | 36        | 362858  | 467875  | 467625   |   |   |   |
| 200 X8 2004->                                  | 35        | 465383  | 467886  |  | 478071  |   | 486835  |
| 250 X9 2001->2004                              | 14        | 450529  | 467879  | 294395   |   |   | 486834  |
| 250 X9 2005->gauche                            | 35        | 465383  | 467886  |  | 478071  |   | 486835  |
| 500 X9 EVOLUTION 2004->                        | 48        | 441465  | 467882  | 482451   |   |   | 486833  |
| <b>Arrière</b>                                 |           |   |   |  |   |   |   |
| 50 DNA   | 17        | 465382  |   |  |   |   |   |
| 50 DNA 2001->                                  | 3         | 3374  |   | 173506   | 464996  | 461297  |   |
| 50 GSM 1999->                                  | 6         | 287550  | 467873  | 282888   | 464999  | 461298  | 486828  |
| 50 HAK 1999->                                  | 6         | 287550  | 467873  | 282888   | 464999  | 461298  | 486828  |
| 50 NRG MC2                                     | 11        | 362896  |   |  |   |   |   |
| 50 NRG MC2 1998->2002                          | 5         | 362907  | 467887  |  |   |   | 486827  |
| 50 NRG MC3 DD 2002->                           | 3         | 3374  |   | 173506   | 464996  | 461297  |   |
| 50 NRG->1999 100x20 (machoire)                 | M         |   |   | 265157   |   |   |   |
| 50 RUNNER 1998->                               | 5         | 362907  | 467887  |  |   |   | 486827  |
| 50 STALKER 1997->2004                          | 5         | 362907  | 467887  |  |   |   | 486827  |
| 50 STALKER 2004->110x25 (machoire x2)          | L         |   | 479804  |  | 493267  |   | 486851  |
| 50 TYPHOON 2004->110x25 (machoire x2)          | L         |   | 479804  |  | 493267  |   | 486851  |
| 50 TYPHOON->1999 100x20 (machoire x2)          | M         |   |   | 265157   |   |   |   |
| 50 TYPHOON Ø140x25                             | N         |   | 485501  |  |   |   |   |
| 50 ZIP 2004->(machoire x2)                     | L         |   | 479804  |  | 493267  |   | 486851  |
| 125   180   200 RUNNER 4 temps GRIMECA 2001->  | 17        | 465382  |   |  |   |   |   |
| 125   180   200 RUNNER 4 temps HENGTONG 2001-> | 17        | 465382  |   |  |   |   |   |
| 125   180 RUNNER   SP GRIMECA 2000->           | 5         | 362907  | 467887  |  |   |   | 486827  |
| 125   180 RUNNER   SP HENGTONG 2000->          | 5         | 362907  | 467887  |  |   |   | 486827  |
| 125   180 SUPER HEXAGON HENGTONG               | 17        | 465382  |   |  |   |   |   |

N° schéma

LIBRERIA CARBONE LIBRERIA

HOFER

TEKNIK

GOMPER

MALOSBI

polini

## PIAGGIO | GILERA

## Arrière

|                          |    |        |        |        |        |  |        |
|--------------------------|----|--------|--------|--------|--------|--|--------|
| 125   250 MP3 2006->2008 | 15 |        | 467884 |        |        |  |        |
| 125 BEVERLY 2001->       | 35 | 465383 | 467886 |        | 478071 |  | 486835 |
| 125 FLY 2003->2008       | 35 | 465383 | 467886 |        | 478071 |  | 486835 |
| 125 MP3                  | 16 | 450527 | 467880 |        |        |  | 486841 |
| 125 MP3                  | 10 |        |        | 489950 |        |  |        |
| 125 TYPHOON ->2011       | N  |        | 485501 |        |        |  |        |
| 125 VESPA PX 1998->      | Q  |        | 490600 |        |        |  |        |
| 125 X7 2008->            | 35 | 465383 | 467886 |        | 478071 |  | 486835 |
| 125 X8                   | 16 | 450527 | 467880 |        |        |  | 486841 |
| 125 X8 2004->            | 14 | 450529 | 467879 | 294395 |        |  | 486834 |
| 125 X8 2005->            | 15 |        | 467884 |        |        |  |        |
| 125 X9 2001->2004        | 14 | 450529 | 467879 | 294395 |        |  | 486834 |
| 125 X9 2005->2007        | 14 | 450529 | 467879 | 294395 |        |  | 486834 |
| 125 X9 HENGTONG 2001->   | 15 |        | 467884 |        |        |  |        |
| 200 X8 2004->            | 14 | 450529 | 467879 | 294395 |        |  | 486834 |
| 250 X9 2001->2004        | 14 | 450529 | 467879 | 294395 |        |  | 486834 |
| 500 X9 EVOLUTION 2004->  | 14 | 450529 | 467879 | 294395 |        |  | 486834 |
| CYCLO CIAO (machoire x1) | J  |        |        | 479774 |        |  |        |

## RIEJU

## Avant

|                             |    |        |        |        |        |        |        |
|-----------------------------|----|--------|--------|--------|--------|--------|--------|
| 50   125 TANGO 2008->       | 14 | 450529 | 467879 | 294395 |        |        | 486834 |
| 50 MRT 2009->2010           | 14 | 450529 | 467879 | 294395 |        |        | 486834 |
| 50 MRT 2009->               | 24 |        | 479778 |        | 484831 |        |        |
| 50 MRX RACING 2003->2008    | 6  | 287550 | 467873 | 282888 | 464999 | 461298 | 486828 |
| 50 NAKED RS2                | 29 | 465386 | 485291 |        |        |        |        |
| 50 RR 1996->2007            | 6  | 287550 | 467873 | 282888 | 464999 | 461298 | 486828 |
| 50 RS1 CASTROL 2001->       | 36 | 362858 | 467875 | 467625 |        |        |        |
| 50 RS1 EVOLUTION 1996->2000 | 6  | 287550 | 467873 | 282888 | 464999 | 461298 | 486828 |
| 50 RS2 MATRIX 2002->2008    | 29 | 465386 | 485291 |        |        |        |        |
| 50 RS3 2011->               | 28 | 465386 | 485291 |        |        |        |        |
| 50 RS3                      | 24 |        | 479778 |        | 484831 |        |        |
| 50 RX 2008->                | 6  | 287550 | 467873 | 282888 | 464999 | 461298 | 486828 |
| 50 SMX 2002->2008           | 6  | 287550 | 467873 | 282888 | 464999 | 461298 | 486828 |
| 50 SMX 2008->               | 14 | 450529 | 467879 | 294395 |        |        | 486834 |
| 50 SPIKE 2002->2008         | 39 | 297155 | 467888 | 467634 |        |        | 486837 |
| 50 SPIKE 2004->2009         | 6  | 287550 | 467873 | 282888 | 464999 | 461298 | 486828 |
| 125 TANGO 2006->2008        | 21 |        | 483106 |        |        |        |        |

## Arrière

|                       |    |        |        |        |        |        |        |
|-----------------------|----|--------|--------|--------|--------|--------|--------|
| 50 MRT 2009->2010     | 22 | 494372 |        |        |        |        |        |
| 50 MRT PRO 2009->2010 | 24 |        | 479778 |        | 484831 |        |        |
| 50 MRX PRO 2001->2008 | 6  | 287550 | 467873 | 282888 | 464999 | 461298 | 486828 |
| 50 NRD 2005->         | 6  | 287550 | 467873 | 282888 | 464999 | 461298 | 486828 |
| 50 RR 1996->2007      | 6  | 287550 | 467873 | 282888 | 464999 | 461298 | 486828 |
| 50 RS1 1997->2000     | 6  | 287550 | 467873 | 282888 | 464999 | 461298 | 486828 |

# PLAQUETTE DE FREIN - MÂCHOIRE DE FREIN / BRAKE PAD - BRAKE SHOE

|                              | N° schéma |        |        |        |        |        |        |
|------------------------------|-----------|--------|--------|--------|--------|--------|--------|
| <b>RIEJU</b>                 |           |        |        |        |        |        |        |
| Arrière                      |           |        |        |        |        |        |        |
| 50 RS2 MATRIX 2002->2010     | 6         | 287550 | 467873 | 282888 | 464999 | 461298 | 486828 |
| 50 RS2 NAKED 2008->2010      | 22        | 494372 |        |        |        |        |        |
| 50 RS3 2011->                | 14        | 450529 | 467879 | 294395 |        |        | 486834 |
| 50 RS3                       | 24        |        | 479778 |        | 484831 |        |        |
| 50 SMX 2002->2008            | 6         | 287550 | 467873 | 282888 | 464999 | 461298 | 486828 |
| 50 SPIKE 2002->              | 6         | 287550 | 467873 | 282888 | 464999 | 461298 | 486828 |
| 125 NAKED 2006               | 25        | 297117 | 467876 | 282873 | 464998 |        | 486839 |
| <b>SACHS</b>                 |           |        |        |        |        |        |        |
| Avant                        |           |        |        |        |        |        |        |
| 50 MAD ASS                   | 9         | 465388 |        | 467649 |        |        |        |
| 50 MAD ASS 2004->            | 38        | 486411 |        | 482453 |        |        |        |
| Arrière                      |           |        |        |        |        |        |        |
| 50 MAD ASS 2005->            | 6         | 287550 | 467873 | 282888 | 464999 | 461298 | 486828 |
| <b>SCOOTER CHINOIS</b>       |           |        |        |        |        |        |        |
| Avant                        |           |        |        |        |        |        |        |
| 50 SCOOTER CHINOIS           | 9         | 465388 |        | 467649 |        |        |        |
| 50 SCOOTER CHINOIS 4 temps   | 38        | 486411 |        | 482453 |        |        |        |
| <b>SHERCO</b>                |           |        |        |        |        |        |        |
| Avant                        |           |        |        |        |        |        |        |
| 50 ENDURO 2002->             | 39        | 297155 | 467888 | 467634 |        |        | 486837 |
| 50 SUPERMOTARD 2002->        | 39        | 297155 | 467888 | 467634 |        |        | 486837 |
| 50 URBAN 2010->2012          | 22        | 494372 |        |        |        |        |        |
| <b>SUZUKI</b>                |           |        |        |        |        |        |        |
| Avant                        |           |        |        |        |        |        |        |
| 50 ADRESS 1992->             | 25        | 297117 | 467876 | 282873 | 464998 |        | 486839 |
| 50 KATANA 1997->             | 3         | 3374   |        | 173506 | 464996 | 461297 |        |
| 50 RMX 1998->                | 6         | 287550 | 467873 | 282888 | 464999 | 461298 | 486828 |
| 50 SMX 1998->                | 6         | 287550 | 467873 | 282888 | 464999 | 461298 | 486828 |
| 125   150 BURGMAN 2003->     | 48        | 441465 | 467882 | 482451 |        |        | 486833 |
| 250   400 BURGMAN 1996->2006 | 13        |        | 479518 |        |        |        |        |
| 650 BURGMAN 2003->2009       | 47        | 452073 |        |        |        |        |        |
| BURGMAN                      | 54        |        | 490592 |        |        |        |        |
| Arrière                      |           |        |        |        |        |        |        |
| 50 RMX 2000->2004            | 6         | 287550 | 467873 | 282888 | 464999 | 461298 | 486828 |
| 50 SMX 1998->                | 6         | 287550 | 467873 | 282888 | 464999 | 461298 | 486828 |
| 125   150 BURGMAN 2003->     | 14        | 450529 | 467879 | 294395 |        |        | 486834 |
| 400 BURGMAN 2007->           | 42        | 452075 | 490593 |        |        |        |        |
| 650 BURGMAN 2003->2009       | 42        | 452075 | 490593 |        |        |        |        |
| <b>SYM</b>                   |           |        |        |        |        |        |        |
| Avant                        |           |        |        |        |        |        |        |
| 50 ALLO 2011->               | 34        | 482072 | 494599 |        |        |        | 486844 |
| 50 CROX 2014->               | 34        | 482072 | 494599 |        |        |        | 486844 |
| 50 FIDDLE 2 2008->2010       | 34        | 482072 | 494599 |        |        |        | 486844 |

# PLAQUETTE DE FREIN - MÂCHOIRE DE FREIN / BRAKE PAD - BRAKE SHOE

N° schéma













## SYM

### Avant

|                              |    |        |        |  |        |        |
|------------------------------|----|--------|--------|--|--------|--------|
| 50 FIDDLE 3 2011->2016       | 34 | 482072 | 494599 |  |        | 486844 |
| 50 JET 4 2009->2010          | 34 | 482072 | 494599 |  |        | 486844 |
| 50 JET 4 NAKED   4R          | 34 | 482072 | 494599 |  |        | 486844 |
| 50 JET all models 2005->2008 | 34 | 482072 | 494599 |  |        | 486844 |
| 50 JET SPORT X 2006->2010    | 34 | 482072 | 494599 |  |        | 486844 |
| 50 JUNGLE 1996->             | 34 | 482072 | 494599 |  |        | 486844 |
| 50 MASK   LC 2000->          | 34 | 482072 | 494599 |  |        | 486844 |
| 50 MIO 2005->                | 68 | 483698 |        |  |        |        |
| 50 ORBIT II 2012->           | 34 | 482072 | 494599 |  |        | 486844 |
| 50 RED EVIL 1999->           | 34 | 482072 | 494599 |  |        | 486844 |
| 50 SYMPHONY 2009             | 34 | 482072 | 494599 |  |        | 486844 |
| 50 SYMPHONY S   SR 2010->    | 34 | 482072 | 494599 |  |        | 486844 |
| 50 SYMPHONY ST 2015->        | 34 | 482072 | 494599 |  |        | 486844 |
| 50 SYMPPLY II 2007->2009     | 34 | 482072 | 494599 |  |        | 486844 |
| 50 X PRO 2014->              | 34 | 482072 | 494599 |  |        | 486844 |
| 100 ALLO 2011->              | 34 | 482072 | 494599 |  |        | 486844 |
| 100 FIDDLE 2 2009->2013      | 34 | 482072 | 494599 |  |        | 486844 |
| 100 JET 1999->               | 34 | 482072 | 494599 |  |        | 486844 |
| 100 JET EURO X 2005->        | 34 | 482072 | 494599 |  |        | 486844 |
| 100 PARTY 1997->             | 34 | 482072 | 494599 |  |        | 486844 |
| 100 SUPER FANCY 1995->1998   | 34 | 482072 | 494599 |  |        | 486844 |
| 110 STAR 2003->              | 34 | 482072 | 494599 |  |        | 486844 |
| 125 ATTILA 1995->2000        | 34 | 482072 | 494599 |  |        | 486844 |
| 125 CROX 2014->              | 34 | 482072 | 494599 |  |        | 486844 |
| 125 FIDDLE II 2009->2013     | 34 | 482072 | 494599 |  |        | 486844 |
| 125 FIDDLE III 2014->2016    | 34 | 482072 | 494599 |  |        | 486844 |
| 125 EURO MX 2002->2009       | 40 | 492565 |        |  |        |        |
| 125 GTS 2007->               | 13 |        | 479518 |  |        |        |
| 125 GT                       | 35 | 465383 | 467886 |  | 478071 | 486835 |
| 125 HD 2005->2006            | 34 | 482072 | 494599 |  |        | 486844 |
| 125 HD EURO 2 2003->2004     | 34 | 482072 | 494599 |  |        | 486844 |
| 125 HD EURO 3 2007->2008     | 34 | 482072 | 494599 |  |        | 486844 |
| 125 HD EVO 2005->2006        | 34 | 482072 | 494599 |  |        | 486844 |
| 125 JET 4 2009               | 34 | 482072 | 494599 |  |        | 486844 |
| 125 JOY RIDE 2001->2009      | 40 | 492565 |        |  |        |        |
| 125 JOY RIDE EVO 2001->2006  | 40 | 492565 |        |  |        |        |
| 125 JOYMAX EVO 2009->2010    | 40 | 492565 |        |  |        |        |
| 125 MEGALO 2002->2007        | 34 | 482072 | 494599 |  |        | 486844 |
| 125 NEW DUKE 2000->2001      | 34 | 482072 | 494599 |  |        | 486844 |
| 125 RS   RS 21 2004->2006    | 40 | 492565 |        |  |        |        |
| 125 SHARK 1999->2002         | 40 | 492565 |        |  |        |        |
| 125 SUPER DUKE 1995->2002    | 34 | 482072 | 494599 |  |        | 486844 |
| 125 SYMPHONY                 | 34 | 482072 | 494599 |  |        | 486844 |
| 125 SYMPPLY 2007->2008       | 34 | 482072 | 494599 |  |        | 486844 |
| 125 SYMPPLY II 2009->2014    | 34 | 482072 | 494599 |  |        | 486844 |

# PLAQUETTE DE FREIN - MÂCHOIRE DE FREIN / BRAKE PAD - BRAKE SHOE

|                              | N° schéma |  |  |  |  |  |  |
|------------------------------|-----------|---|---|--|---|---|---|
| <b>SYM</b>                   |           |   |   |  |   |   |   |
| <b>Avant</b>                 |           |   |   |  |   |   |   |
| 125 VOYAGER 2006->2009       | 71        | 493244  |   |  |   |   |   |
| 125 WOLF 2005->              | 38        | 486411  |   | 482453   |   |   |   |
| 125 WOLF LEGENDE 2002->      | 38        | 486411  |   | 482453   |   |   |   |
| 125 X PRO 2013->             | 34        | 482072  | 494599  |  |   |   | 486844  |
| 150 ATTILA 2000->2001        | 34        | 482072  | 494599  |  |   |   | 486844  |
| 150 CROX 2014->              | 34        | 482072  | 494599  |  |   |   | 486844  |
| 150 FIDDLE II 2010->2012     | 34        | 482072  | 494599  |  |   |   | 486844  |
| 150 JOY RIDE EVO 2001->2006  | 40        | 492565  |   |  |   |   |   |
| 150 RS 2005->2014            | 40        | 492565  |   |  |   |   |   |
| 150 SHARK 4 temps            | 40        | 492565  |   |  |   |   |   |
| 150 SYMPHONY 2009            | 34        | 482072  | 494599  |  |   |   | 486844  |
| 200 FIDDLE II 2011->         | 34        | 482072  | 494599  |  |   |   | 486844  |
| 200 FIDDLE III 2016          | 34        | 482072  | 494599  |  |   |   | 486844  |
| 200 HD EVO 2011->            | 34        | 482072  | 494599  |  |   |   | 486844  |
| 200 HD EVO EURO 2 2005->2006 | 34        | 482072  | 494599  |  |   |   | 486844  |
| 200 HD EVO EURO 3 2007->2010 | 34        | 482072  | 494599  |  |   |   | 486844  |
| 200 HD EVO EURO 3 2008->2009 | 34        | 482072  | 494599  |  |   |   | 486844  |
| 200 HD2 EVO 2013->           | 34        | 482072  | 494599  |  |   |   | 486844  |
| 200 JOY RIDE EVO 2001->2006  | 40        | 492565  |   |  |   |   |   |
| 200 JOY RIDE 2003->2007      | 40        | 492565  |   |  |   |   |   |
| 250 GTS 2007->               | 14        |   | 479518  |  |   |   |   |
| 300 CITYCOM 2008->2009       | 34        | 482072  | 494599  |  |   |   | 486844  |
| 300 CITYCOM EFI 2010->2011   | 34        | 482072  | 494599  |  |   |   | 486844  |
| 300 CITYCOM CBS 2012         | 34        | 482072  | 494599  |  |   |   | 486844  |
| 300 CITYCOM S 2016           | 34        | 482072  | 494599  |  |   |   | 486844  |
| <b>Arrière</b>               |           |   |   |  |   |   |   |
| 125 FIDDLE 2                 | P         |   | 490597  |  |   |   |   |
| 125 FIDDLE 3                 | P         |   | 490597  |  |   |   |   |
| 125 HD EVO 2007->2010        | 71        | 493244  |   |  |   |   |   |
| 125 JET 4                    | P         |   | 490597  |  |   |   |   |
| 125 JOY RIDE 2007->2009      | 71        | 493244  |   |  |   |   |   |
| 125 JOYMAX EVO 2009->2010    | 71        | 493244  |   |  |   |   |   |
| 125 SYMPHONY                 | P         |   | 490597  |  |   |   |   |
| 125 VOYAGER 2006->2009       | 71        | 493244  |   |  |   |   |   |
| 200 EVO HD EURO 2            | 71        | 493244  |   |  |   |   |   |
| 200 HD EVO I EURO 3          | 71        | 493244  |   |  |   |   |   |
| 200 JOY RIDE EVO             | 71        | 493244  |   |  |   |   |   |
| 250 JOY MAX 2006->2009       | 71        | 493244  |   |  |   |   |   |
| 300 CITYCOM 2008->2009       | 71        | 493244  |   |  |   |   |   |
| 300 CITYCOM 2008->2009       | 34        | 482072  | 494599  |  |   |   | 486844  |
| 300 CITYCOM EFI 2010->2011   | 34        | 482072  | 494599  |  |   |   | 486844  |
| 300 CITYCOM CBS 2012         | 34        | 482072  | 494599  |  |   |   | 486844  |
| 300 CITYCOM S 2016           | 34        | 482072  | 494599  |  |   |   | 486844  |
| 300 GTS 2008->2009           | 71        | 493244  |   |  |   |   |   |
| 300 JOY MAX 2009->2010       | 71        | 493244  |   |  |   |   |   |









## BOÎTE DE 20 PAIRES DE PLAQUETTES DE FREIN

| N° Schéma |    |               |   |
|-----------|----|---------------|---|
| 498256    | 25 | avant         | SPEEDFIGHT   KISBEE   SENDA DRD RACING    |
| 498255    | 6  | avant/arrière | SENDA   AJP   SPEEDFIGHT   VIVACITY   TKR |
| 498254    | 3  | avant         | BOOSTER   NITRO   BUXY   TYPHOON          |
| 498253    | 8  | arrière       | NITRO   AEROX + AV STUNT   SLIDER         |

## TABLEAU RÉCAPITULATIF DES RÉFÉRENCES DE PLAQUETTES

| N° schéma |        |        |        |        |        |        |
|-----------|--------|--------|--------|--------|--------|--------|
| 1         |        | 467870 |        |        |        | 486826 |
| 2         |        | 467877 |        |        |        |        |
| 3         | 3374   |        | 173506 | 464996 | 461297 |        |
| 4         | 297705 | 467878 |        |        |        |        |
| 5         | 362907 | 467887 |        |        |        | 486827 |
| 6         | 287550 | 467873 | 282888 | 464999 | 461298 | 486828 |
| 7         | 450526 |        |        |        |        |        |
| 8         | 297136 | 467871 | 282840 | 464997 | 461299 | 486830 |
| 9         | 465388 |        | 467649 |        |        |        |
| 10        |        |        | 489950 |        |        |        |
| 11        | 362896 |        |        |        |        |        |
| 12        | 168663 | 467872 |        |        |        |        |
| 13        |        | 479518 |        |        |        |        |
| 14        | 450529 | 467879 | 294395 |        |        | 486834 |
| 14        | 486412 |        |        |        |        |        |
| 15        |        | 467884 |        |        |        |        |
| 16        | 450527 | 467880 |        |        |        | 486841 |
| 17        | 465382 |        |        |        |        |        |
| 18        | 452068 | 467885 | 482452 |        |        | 486836 |
| 19        |        | 483108 | 482450 |        |        |        |
| 20        | 492566 | 490595 |        |        |        |        |
| 21        |        | 483106 |        |        |        |        |
| 22        | 494372 |        |        |        |        |        |
| 23        | 839    |        |        |        |        |        |
| 24        |        | 479778 |        | 484831 |        |        |
| 25        | 297117 | 467876 | 282873 | 464998 |        | 486839 |
| 26        |        | 483107 |        |        |        |        |
| 27        |        |        | 483815 |        |        |        |
| 28        | 492564 |        |        |        |        |        |
| 28        | 486720 |        |        |        |        |        |
| 29        | 465386 | 485291 |        |        |        |        |
| 30        | 465393 |        | 480094 |        |        |        |
| 31        | 465384 | 467890 | 467647 |        |        |        |
| 32        | 297083 |        |        |        |        |        |

## TABLEAU RÉCAPITULATIF DES RÉFÉRENCES DE PLAQUETTES

| N° schéma |  |  |  |  |  |  |
|-----------|---|---|---|---|---|--|
| 33        | 494261  | 479779  |   |   |   |  |
| 34        | 482072  | 494599  |   |   |   | 486844   |
| 35        | 465383  | 467886  |   | 478071  |   | 486835   |
| 36        | 362858  | 467875  | 467625  |   |   |  |
| 37        |   | 485503  |   |   |   | 486829   |
| 38        | 486411  |   | 482453  |   |   |  |
| 39        | 297155  | 467888  | 467634  |   |   | 486837   |
| 40        | 492565  |   |   |   |   |  |
| 41        | 450523  |   |   |   |   |  |
| 42        | 452075  | 490593  |   |   |   |  |
| 43        |   | 490594  |   |   |   |  |
| 44        |   | 494597  |   |   |   |  |
| 45        | 492561  |   |   |   |   |  |
| 46        | 481796  | 490590  |   |   |   | 486838   |
| 47        | 452073  |   |   |   |   |  |
| 48        | 441465  | 467882  | 482451  |   |   | 486833   |
| 49        | 468270  | 479514  |   |   |   | 486842   |
| 50        | 452066  |   |   |   |   |  |
| 51        | 492563  |   |   |   |   |  |
| 52        |   | 483105  |   |   |   |  |
| 53        | 450524  |   |   |   |   |  |
| 54        |   | 490592  |   |   |   |  |
| 55        | 494459  |   |   |   |   |  |
| 56        | 492562  |   |   |   |   |  |
| 57        |   | 485502  |   |   |   | 486845   |
| 58        | 495992  |   |   |   |   |  |
| 59        | 492560  | 485292  |   |   |   | 486846   |
| 60        | 465387  | 467883  |   |   |   | 486840   |
| 61        | 465392  | 490596  |   |   |   |  |
| 62        | 450525  |   |   |   |   |  |
| 63        | 465380  | 467874  |   |   |   | 486843   |
| 64        |   | 494598  |   |   |   |  |
| 65        | 481795  |   |   |   |   | 486832   |
| 66        | 465381  |   |   |   |   |  |
| 67        | 495999  | 490591  |   |   |   |  |
| 68        | 483698  |   |   |   |   |  |
| 69        | 362881  | 481919  | 482454  |   |   |  |
| 70        | 297098  |   | 282854  | 465004  |   | 486831   |
| 71        |   | 493244  |   |   |   |  |



# NEWFREN

BRAKE & CLUTCH TECHNOLOGY



RACING - STREET - OFF ROAD - VINTAGE - SCOOTER - MOPEDS - ATV



Disques de frein



Plaquettes de frein



Embrayage



Mâchoires de frein



Web. [www.newfren.com](http://www.newfren.com)



# PLAQUETTE DE FREIN - MÂCHOIRE DE FREIN / BRAKE PAD - BRAKE SHOE

1

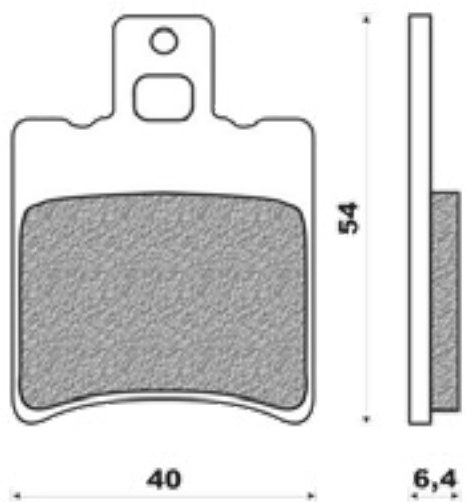

2

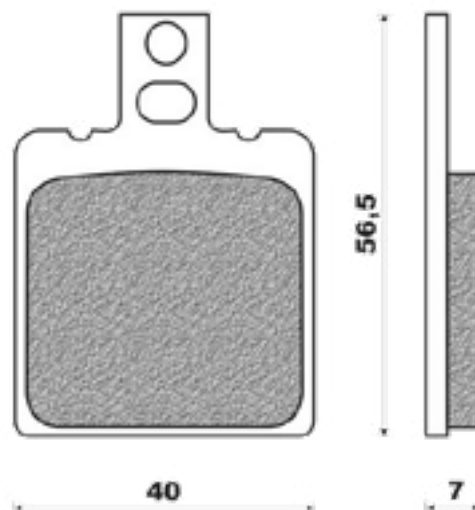

3

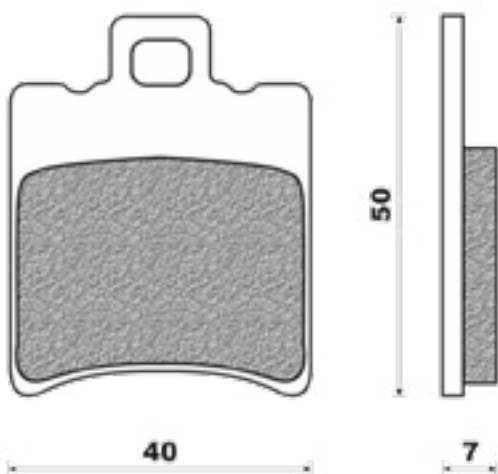

4

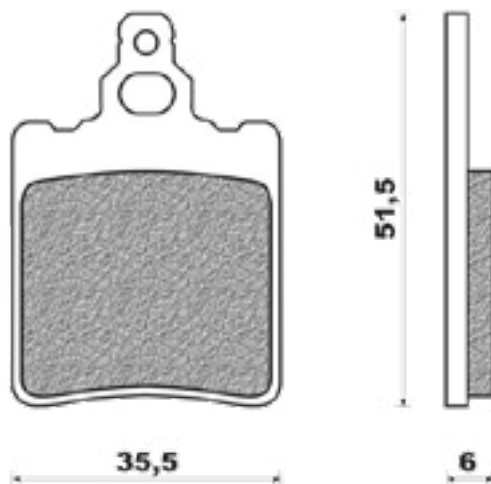

5

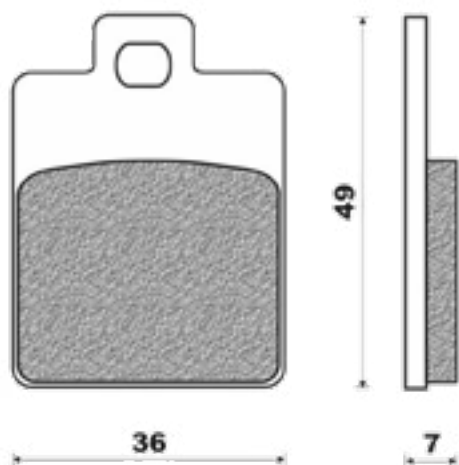

6

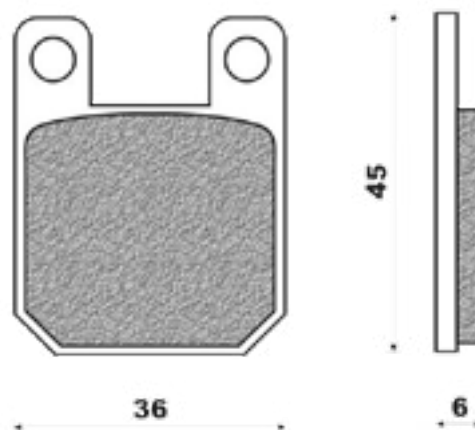

## PLAQUETTE DE FREIN - MÂCHOIRE DE FREIN / BRAKE PAD - BRAKE SHOE

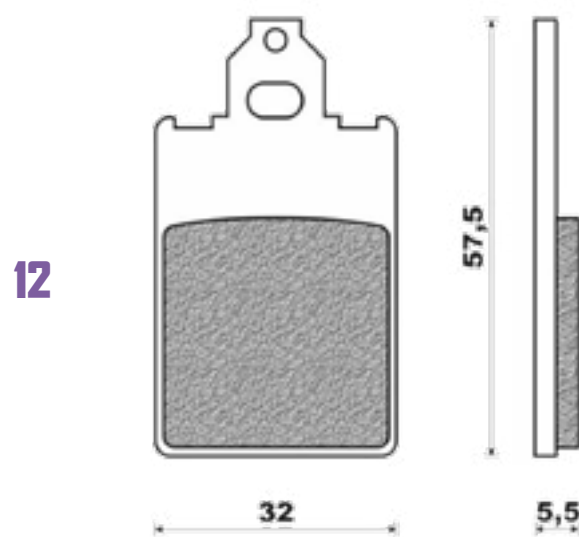
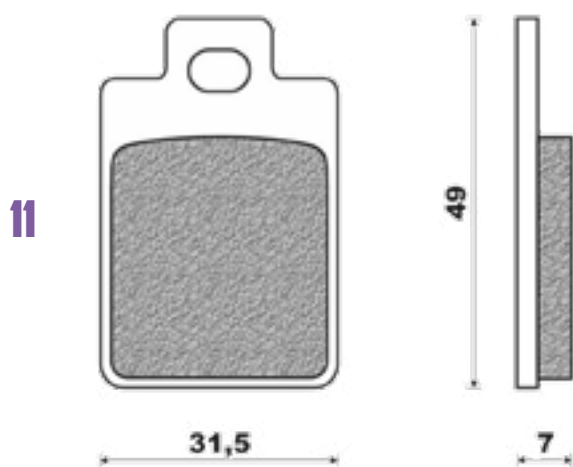
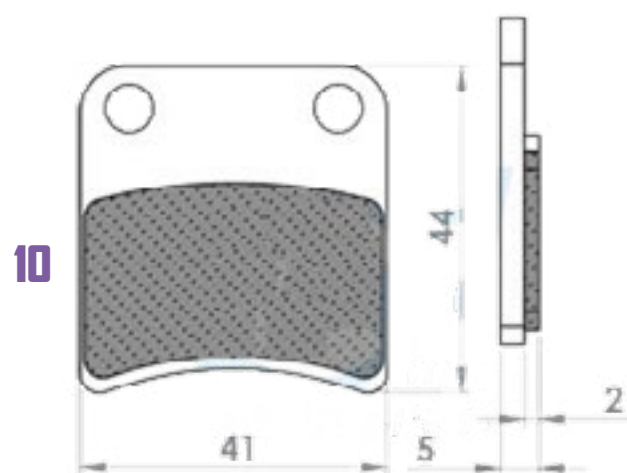
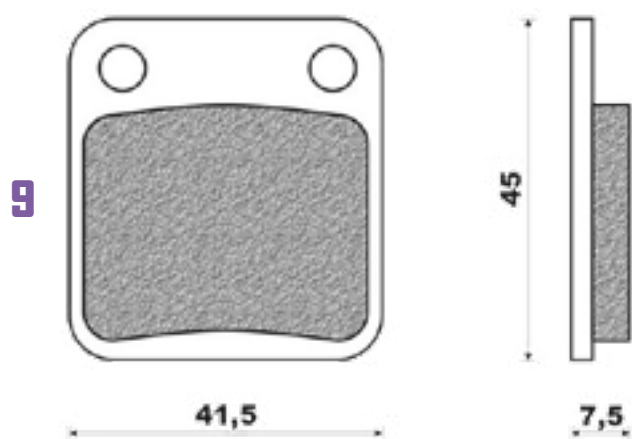
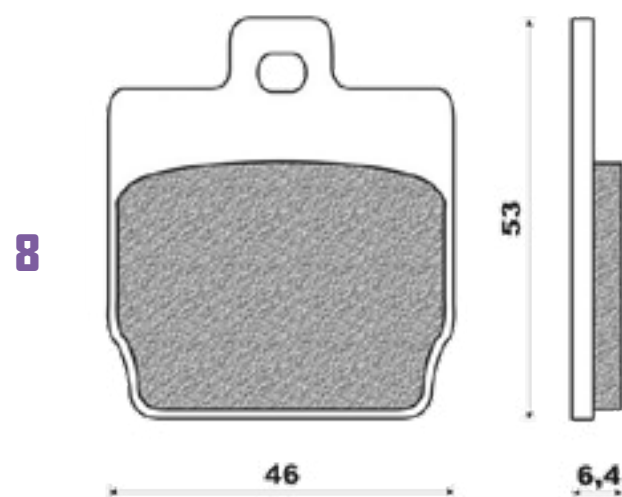
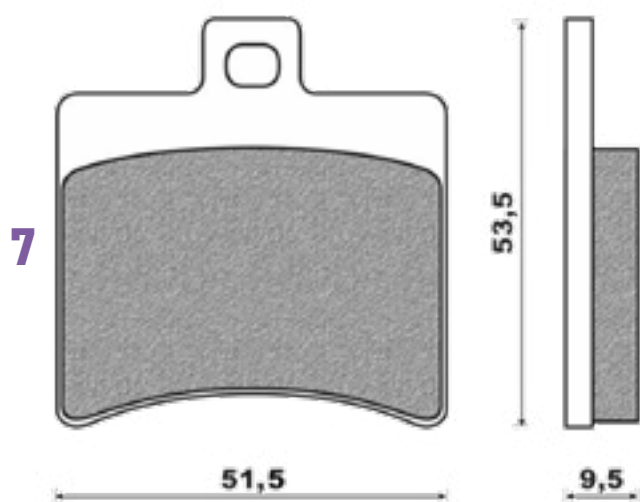

# PLAQUETTE DE FREIN - MÂCHOIRE DE FREIN / BRAKE PAD - BRAKE SHOE

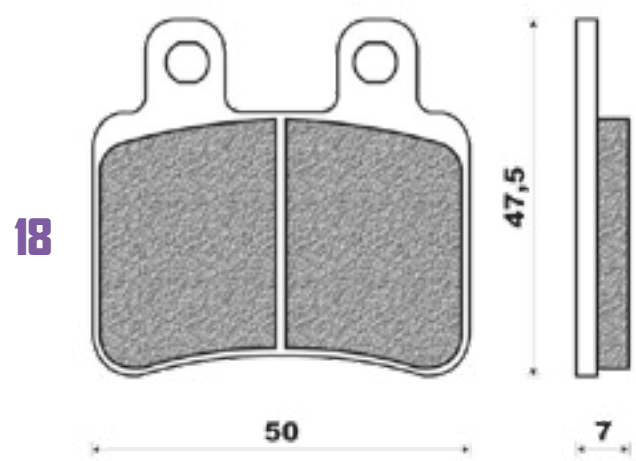
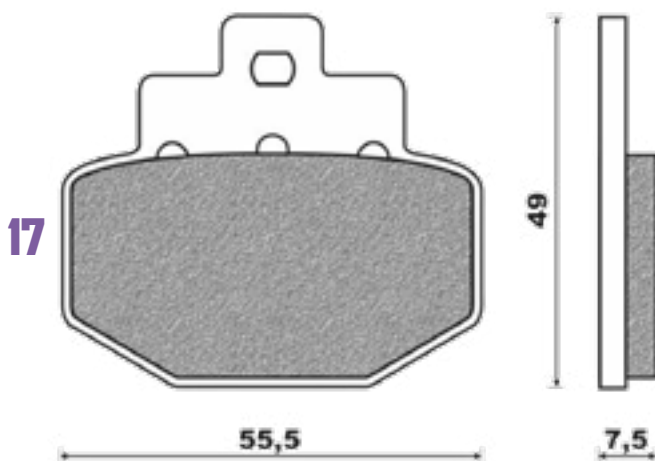
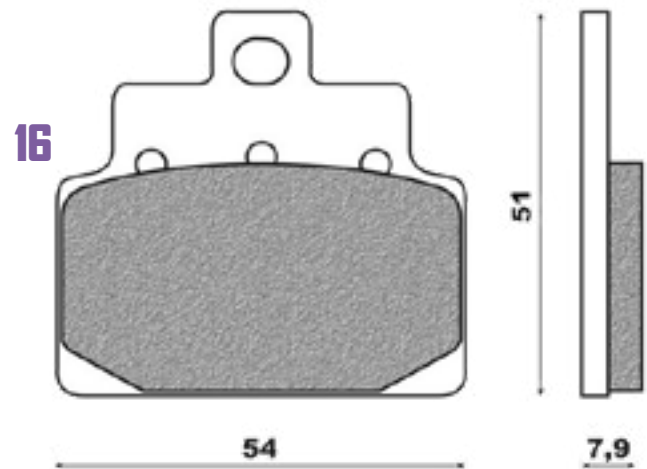
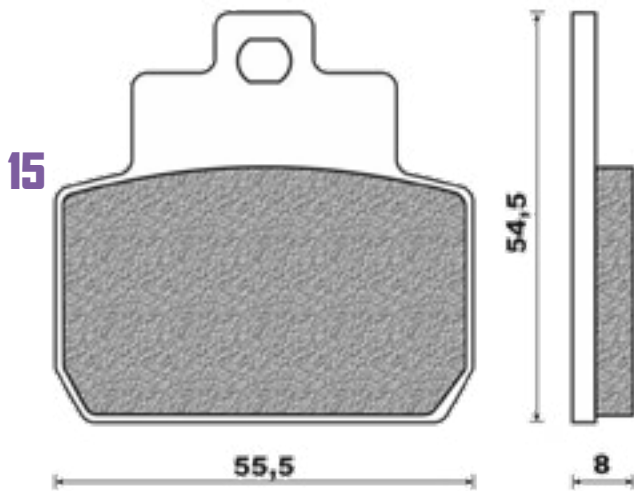
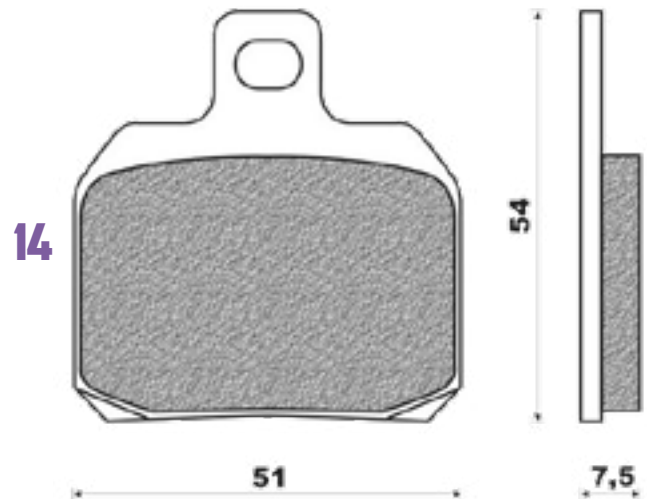
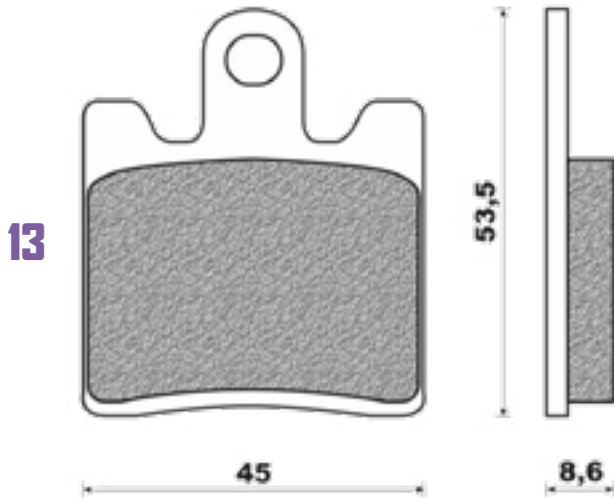

19

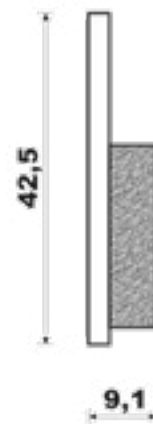
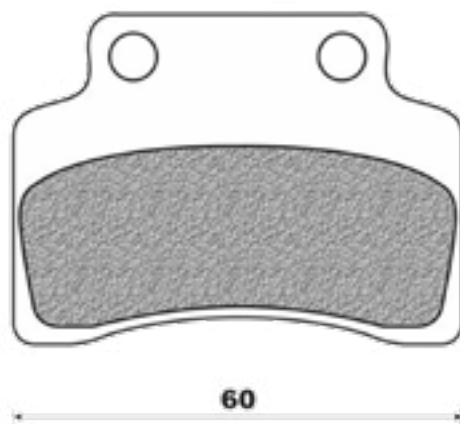

20

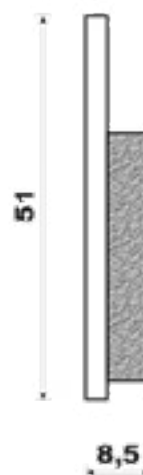
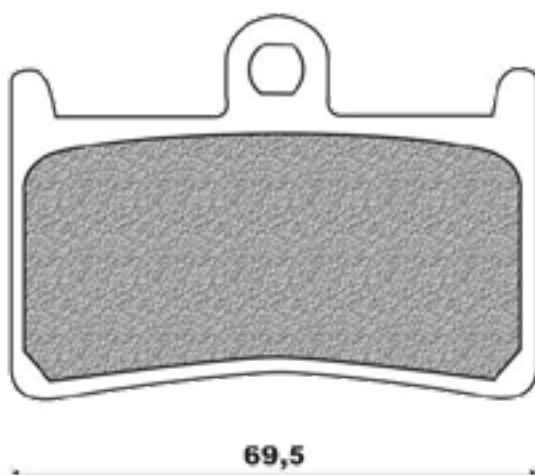

21

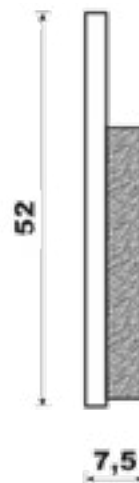
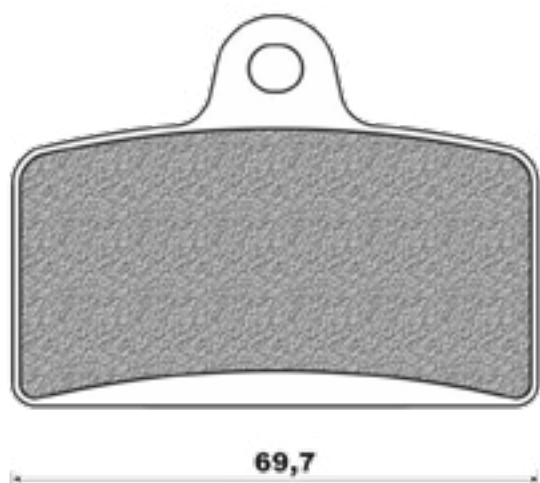

22

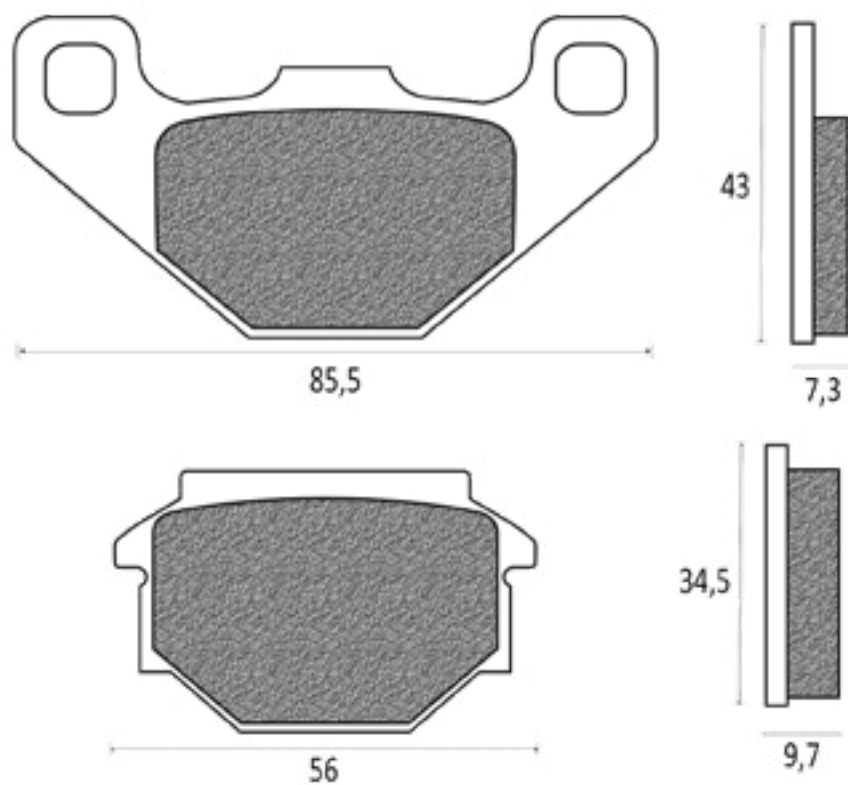

23

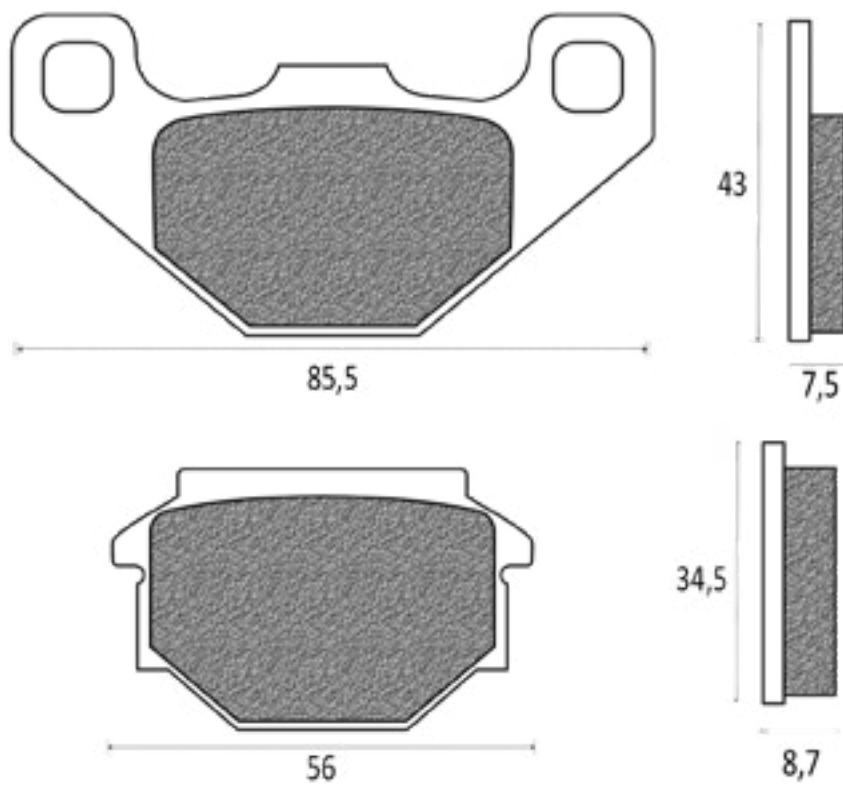

PLAQUETTE DE FREIN - MÂCHOIRE DE FREIN / BRAKE PAD - BRAKE SHOE

24

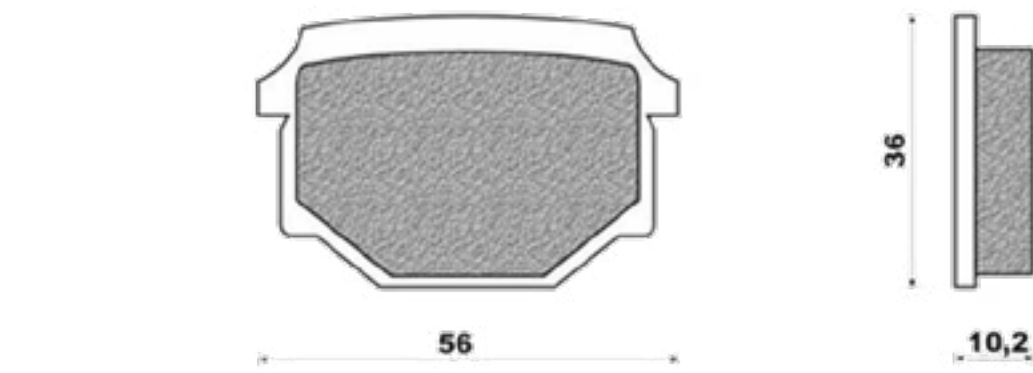
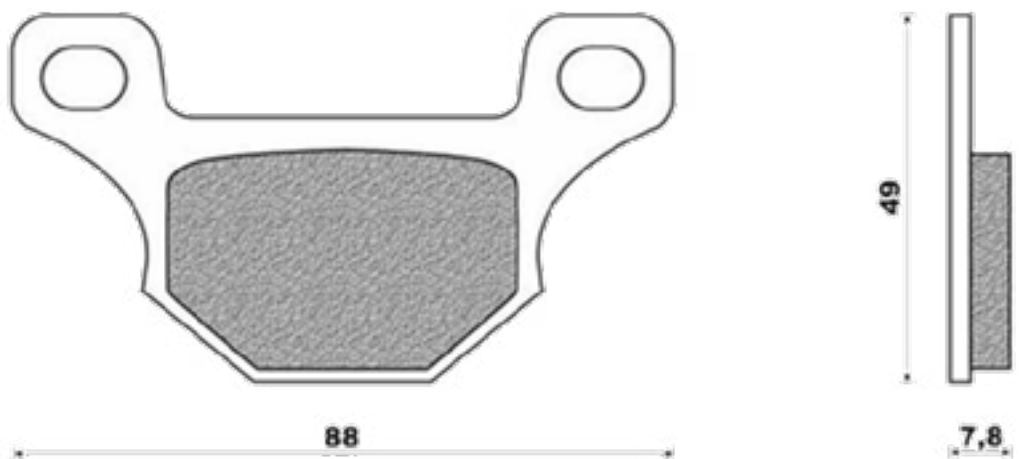

25

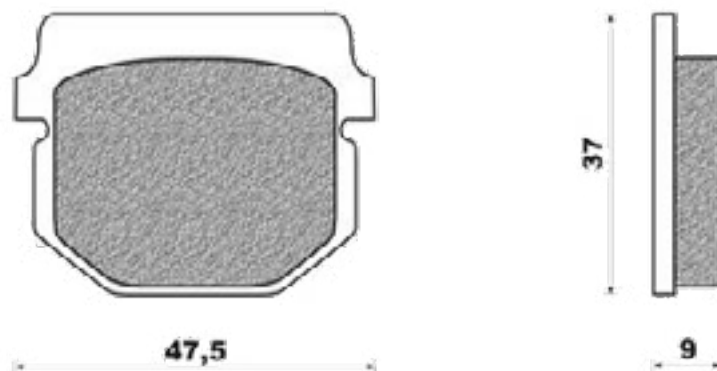
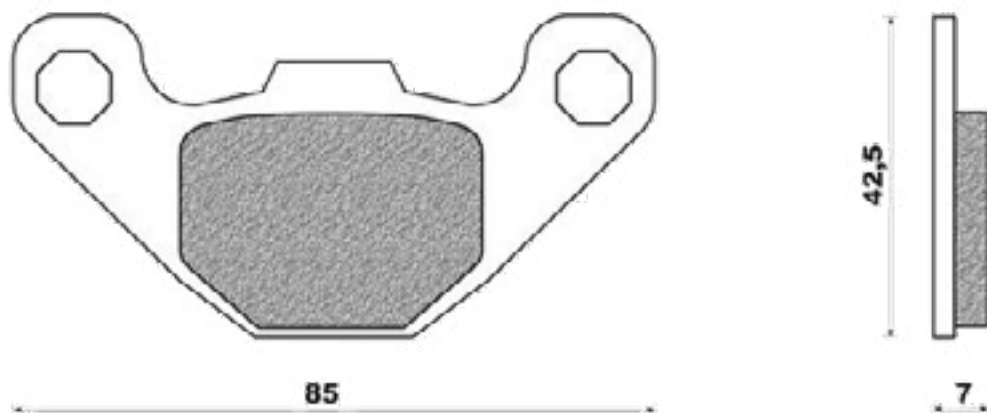

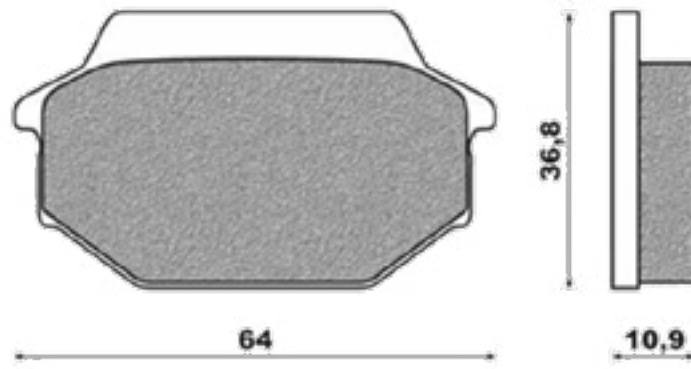

26

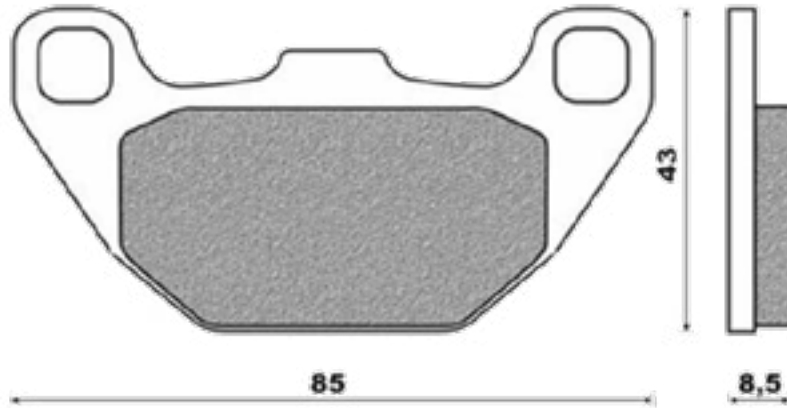

27

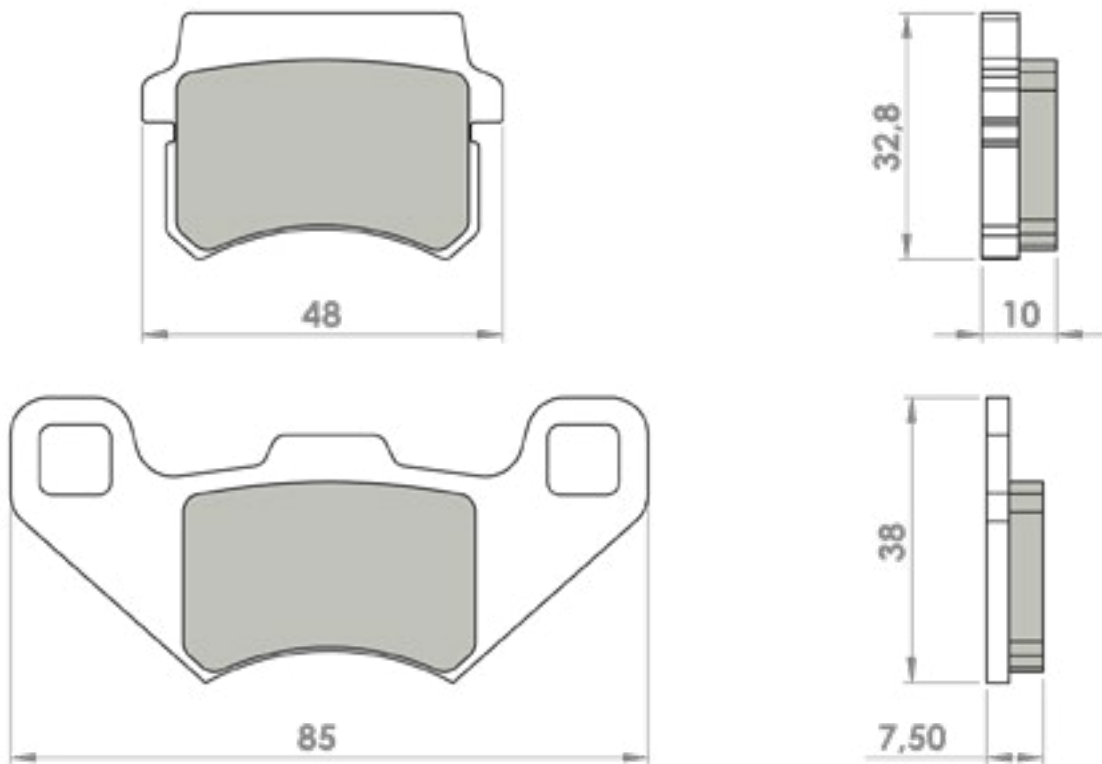

28

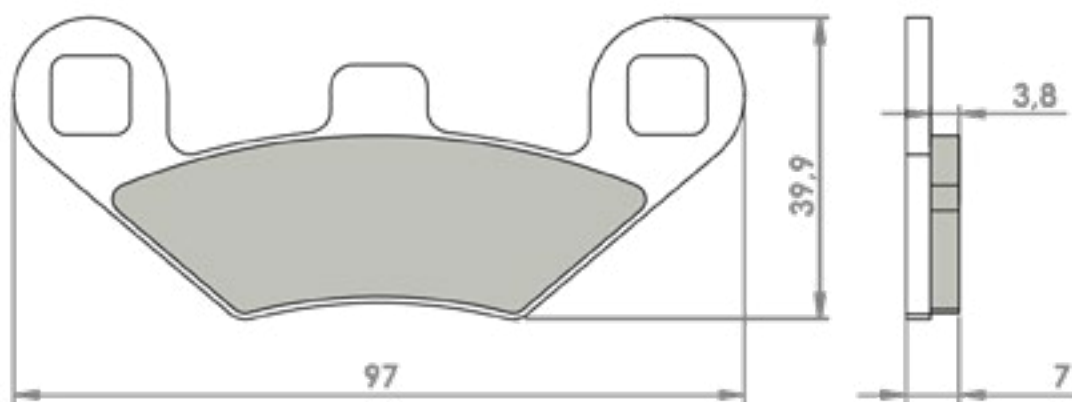

29

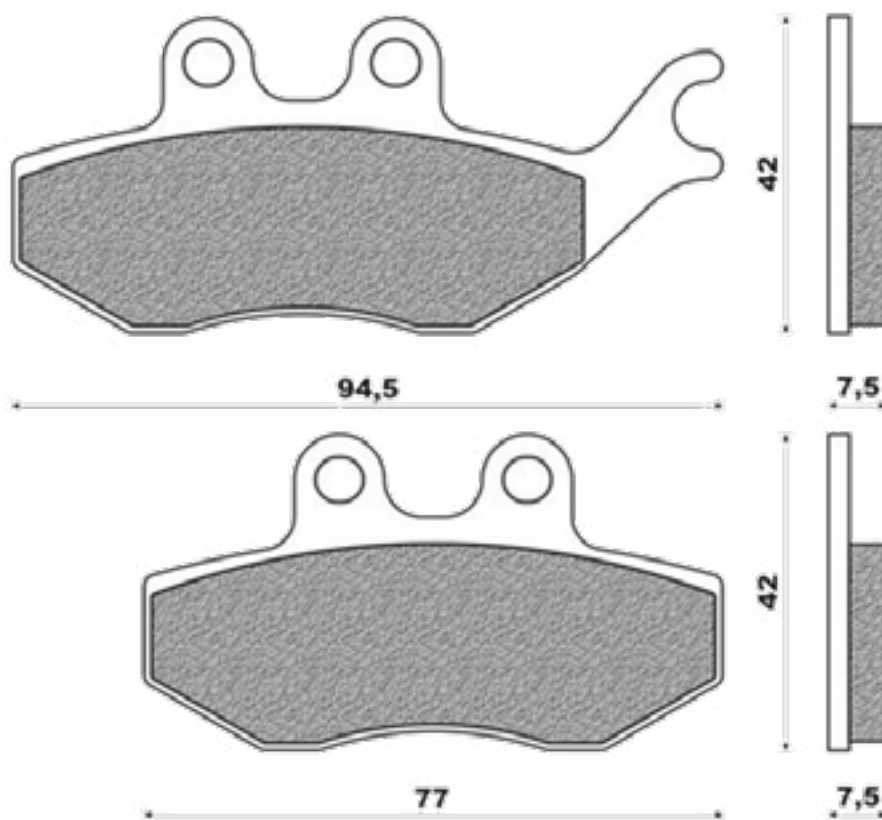



# PLAQUETTE DE FREIN - MÂCHOIRE DE FREIN / BRAKE PAD - BRAKE SHOE

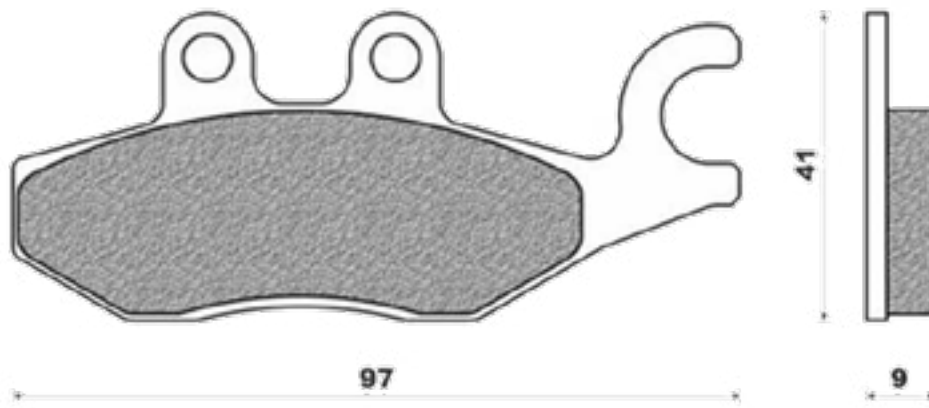

30

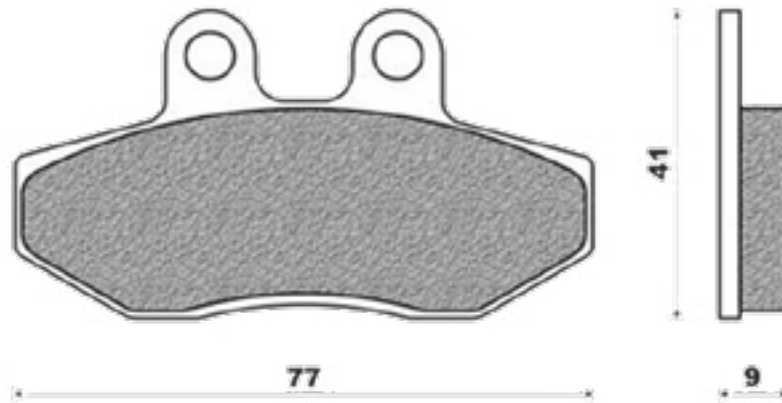

31

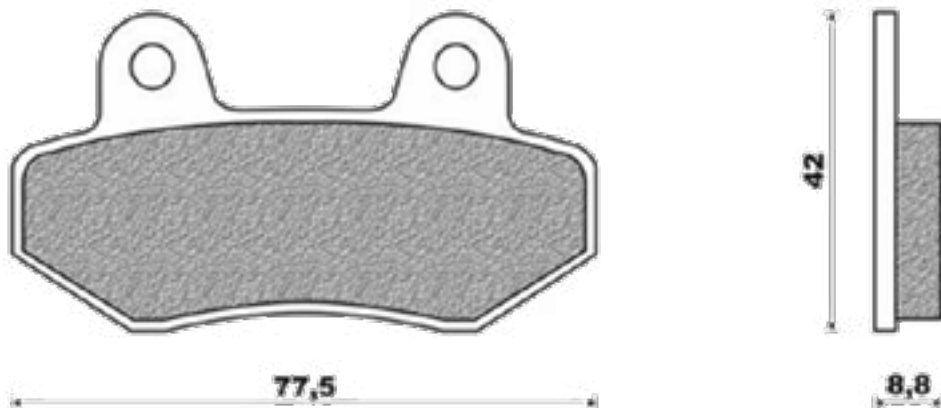
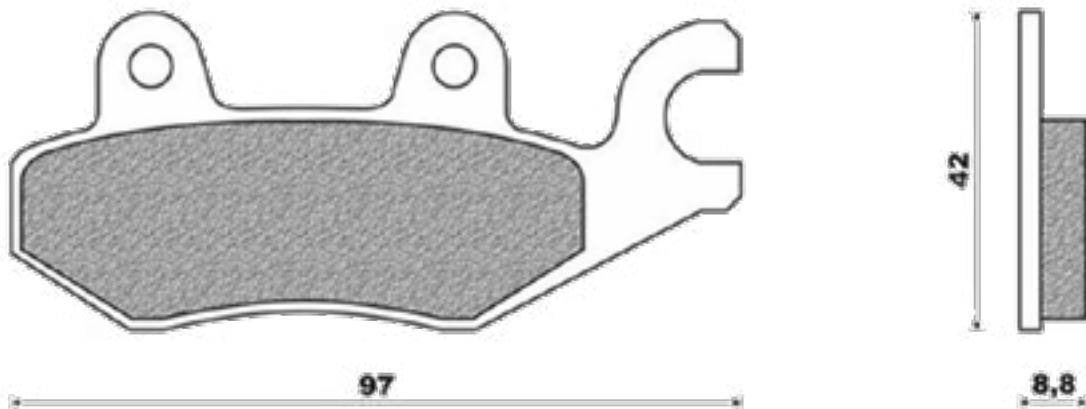

PLAQUETTE DE FREIN - MÂCHOIRE DE FREIN / BRAKE PAD - BRAKE SHOE

32

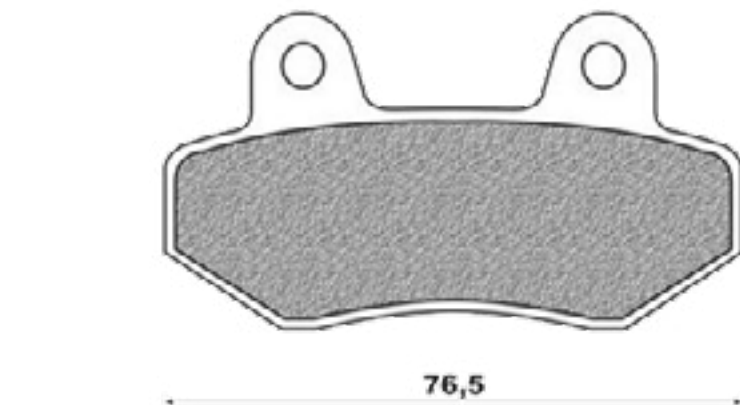
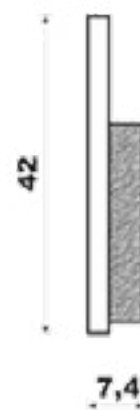
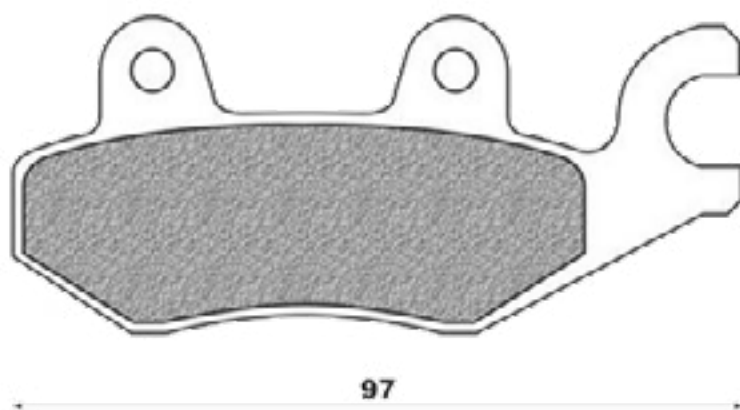

33

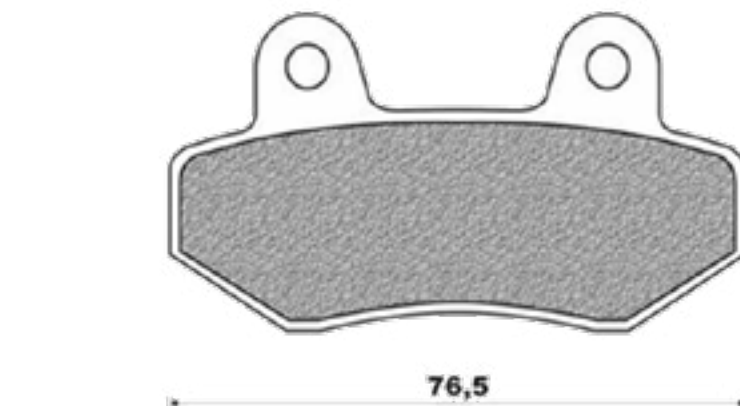
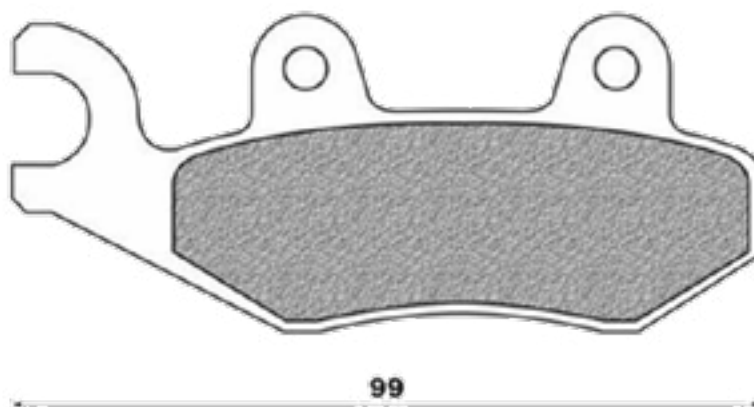

34

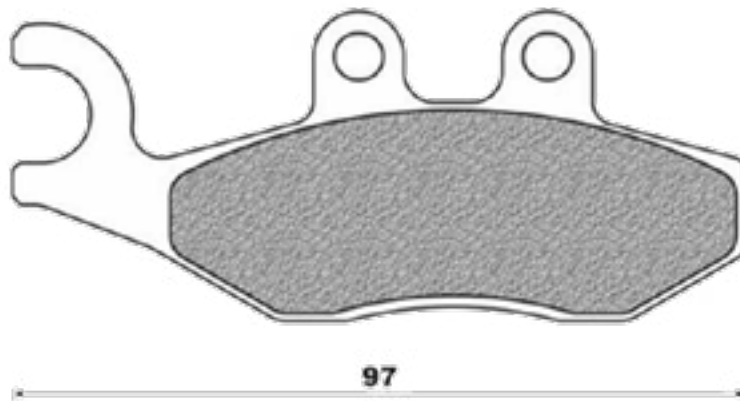
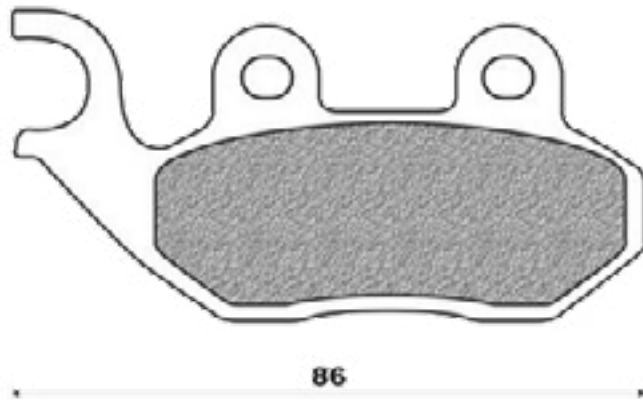
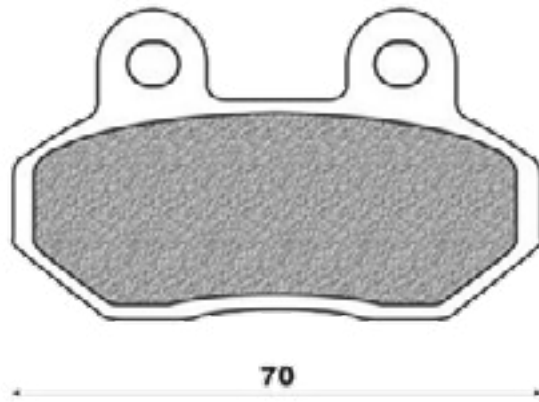

35

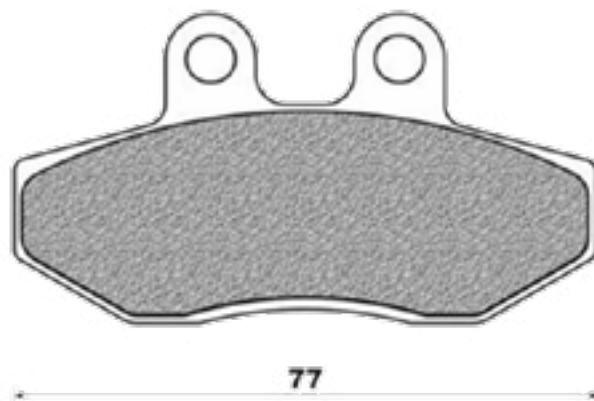

PLAQUETTE DE FREIN - MÂCHOIRE DE FREIN / BRAKE PAD - BRAKE SHOE

36

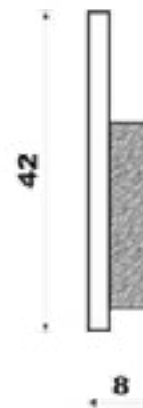
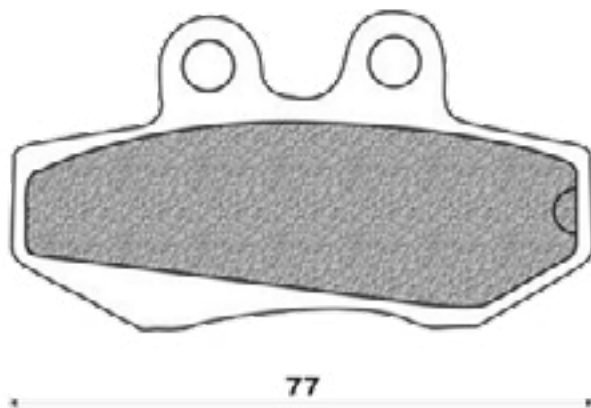
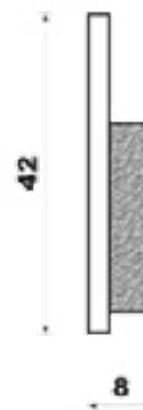
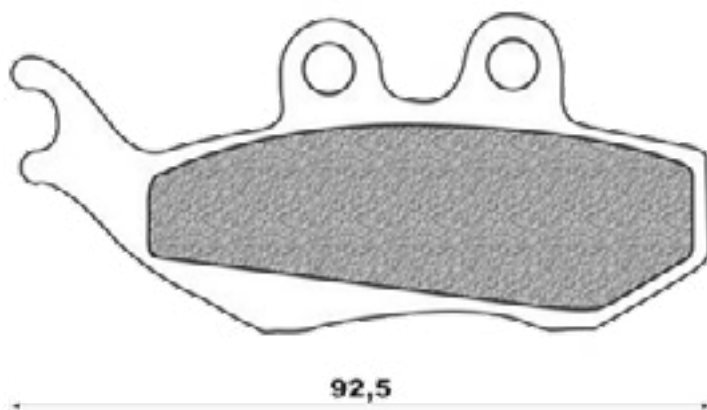

37

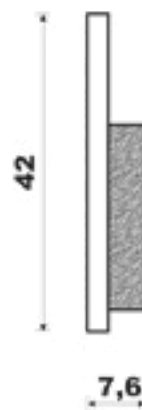
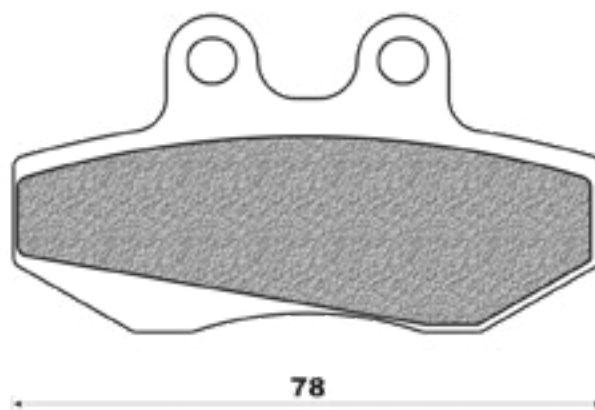
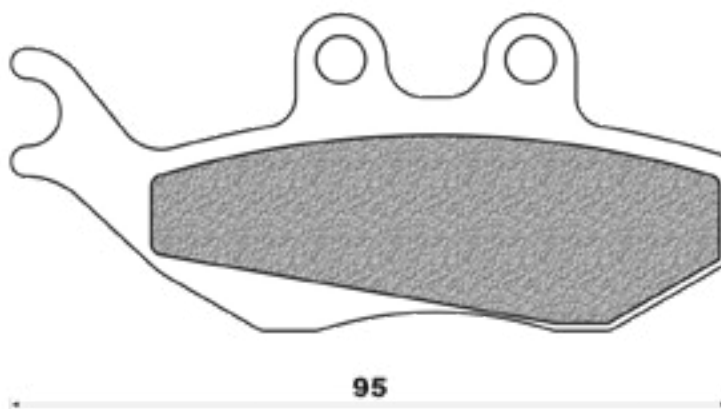

38

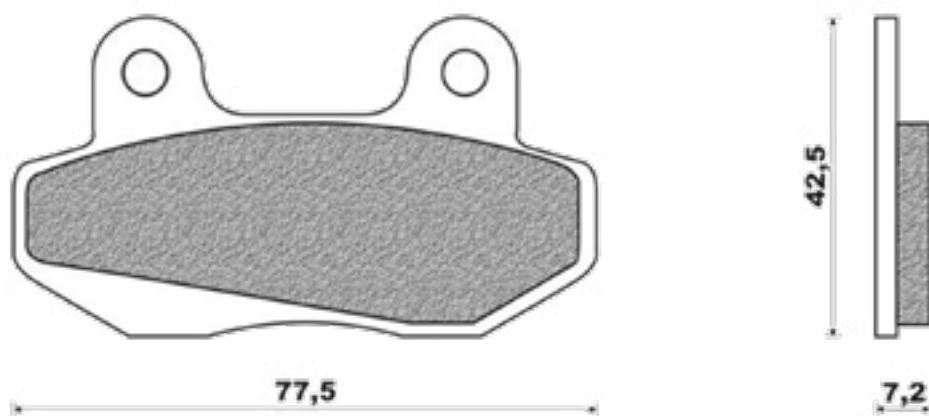

39

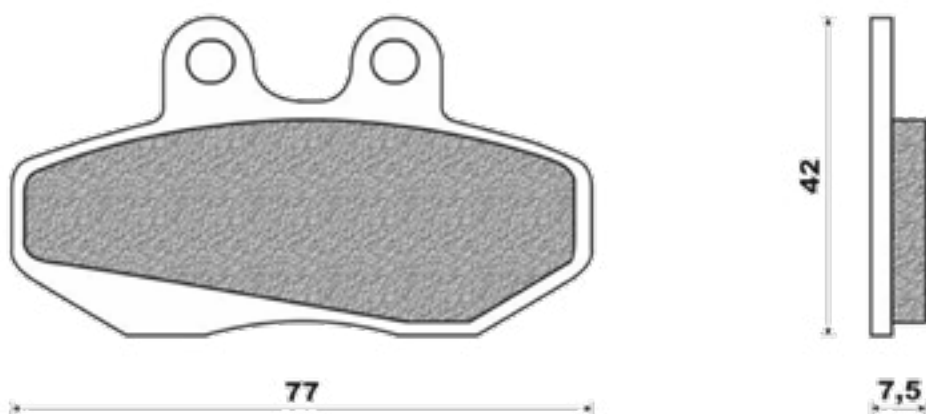

40

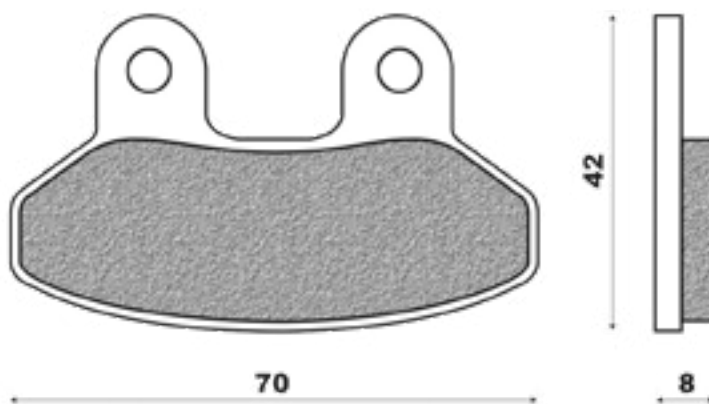

41

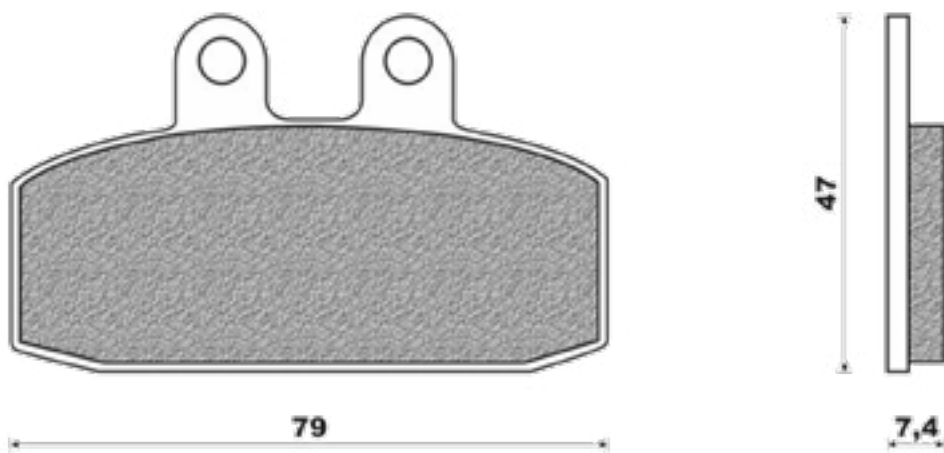

42

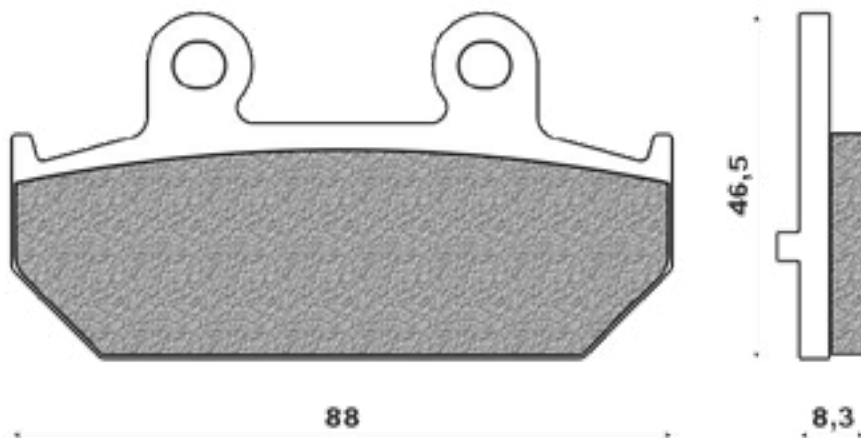

43

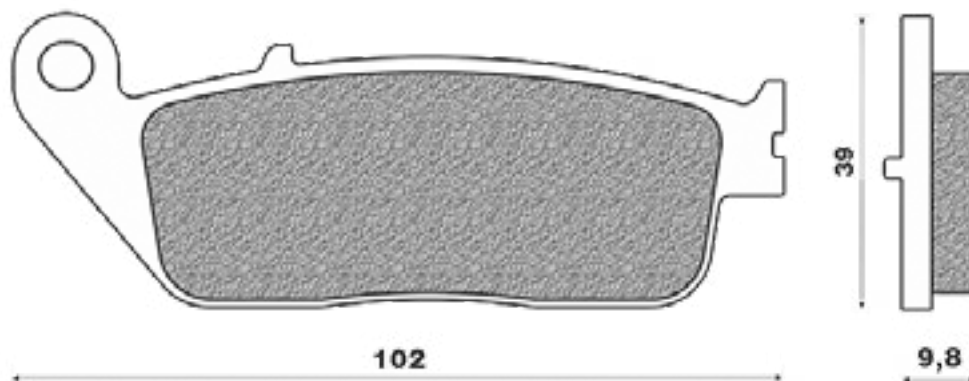

44

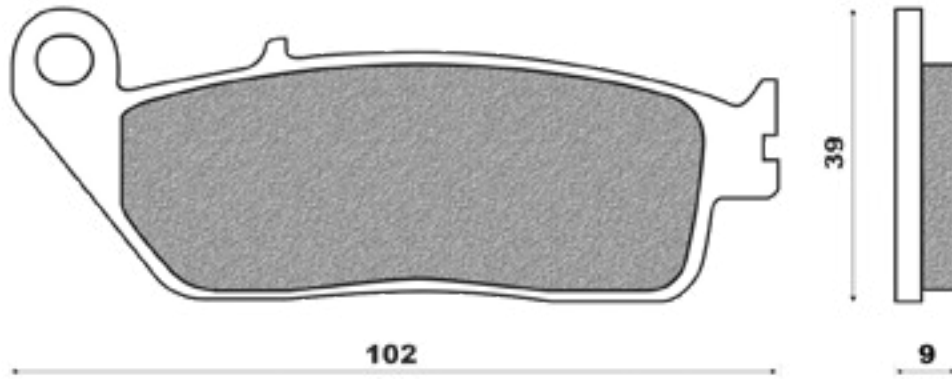

45

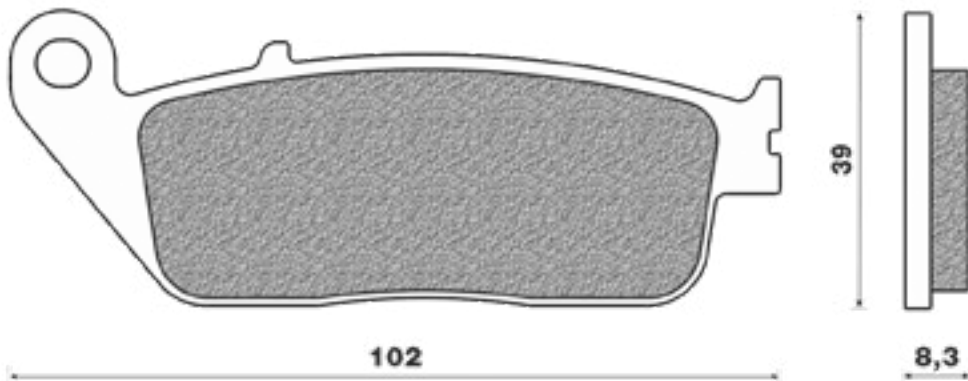

46

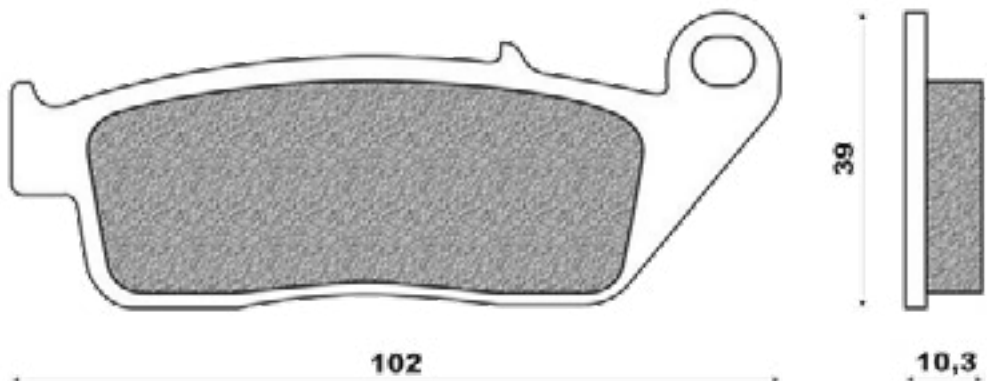
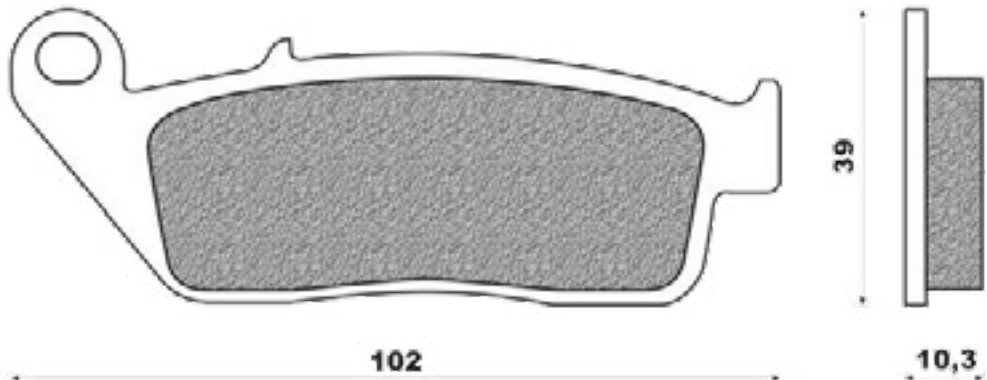

PLAQUETTE DE FREIN - MÂCHOIRE DE FREIN / BRAKE PAD - BRAKE SHOE

47

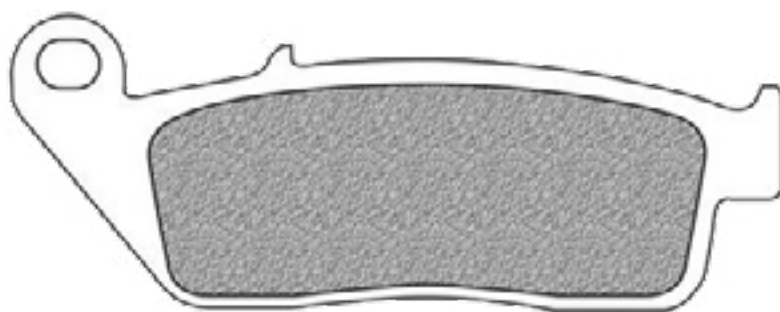

102

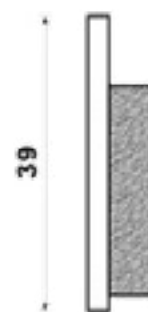

39

8,3

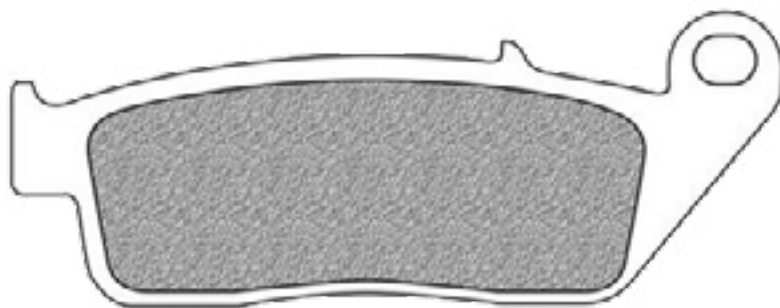

102

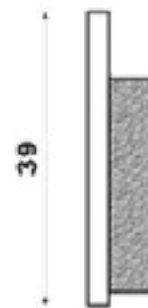

39

8,3

48

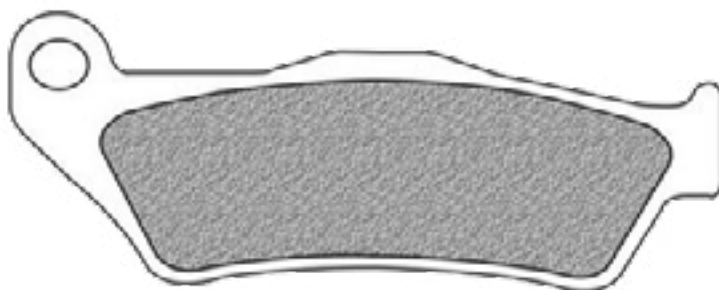

94,5

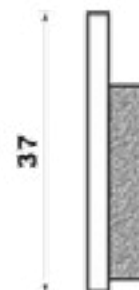

37

7,5

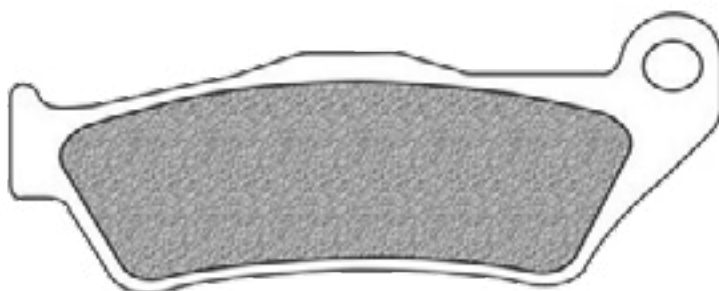

94,5

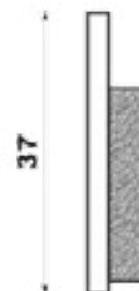

37

7,5



49

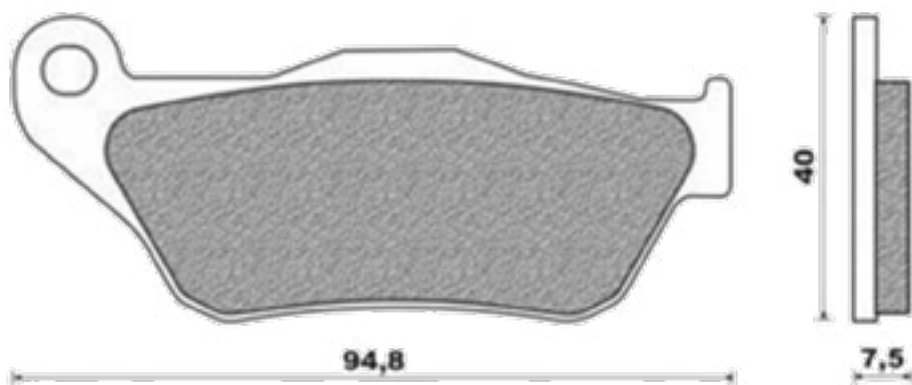

50

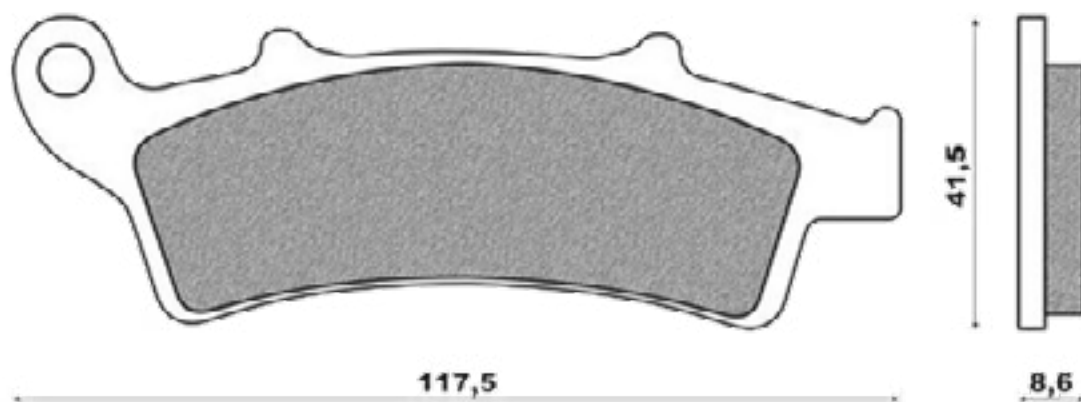
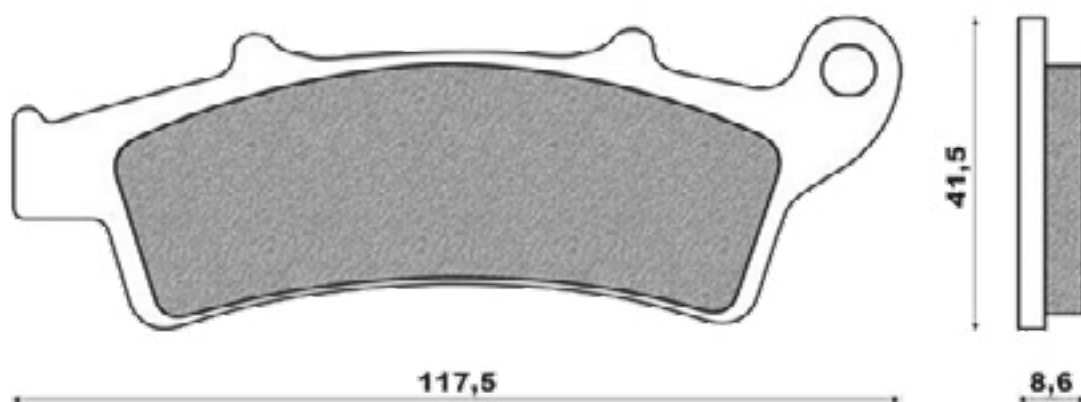

PLAQUETTE DE FREIN - MÂCHOIRE DE FREIN / BRAKE PAD - BRAKE SHOE

51

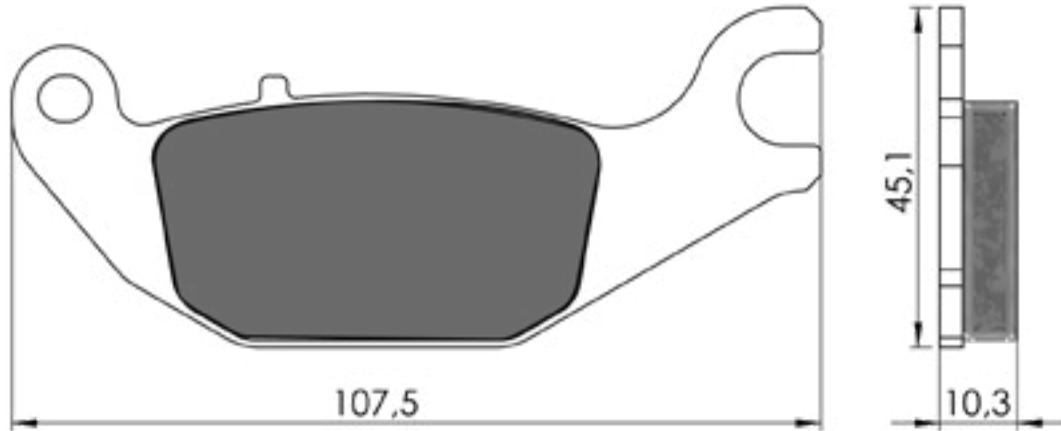
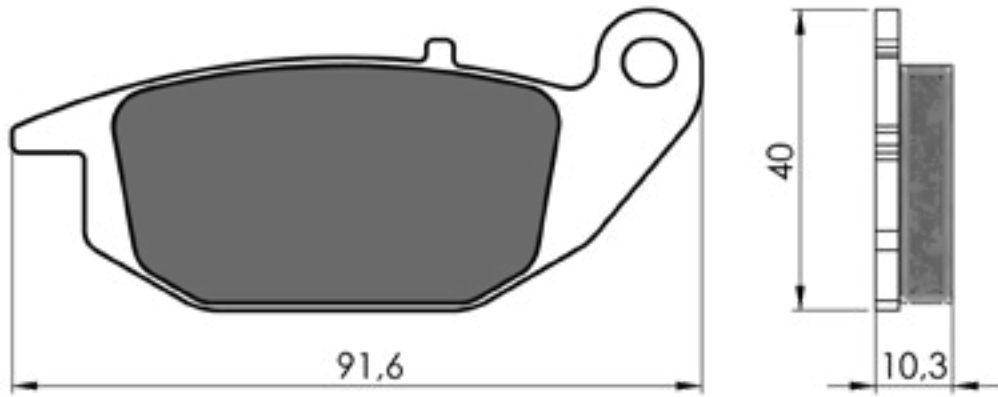

52

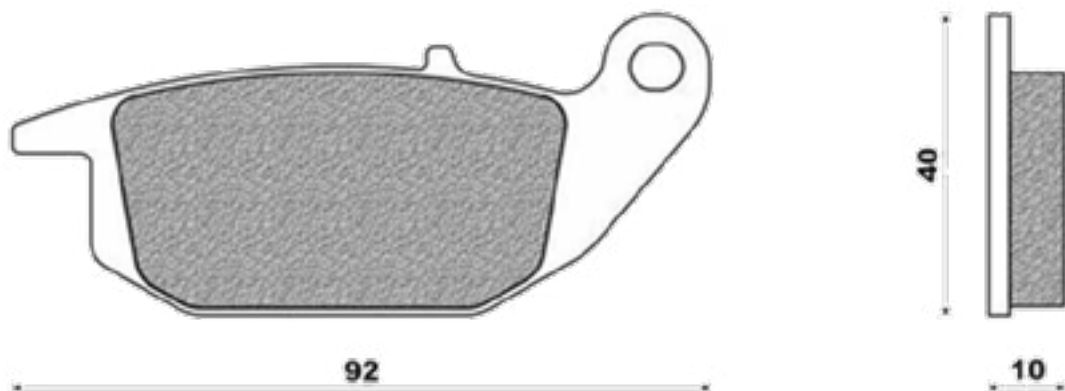
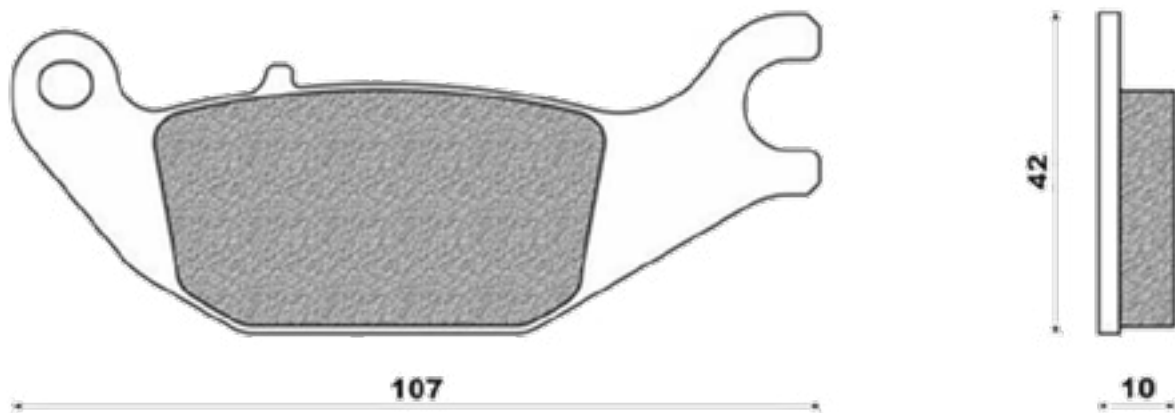

# PLAQUETTE DE FREIN - MÂCHOIRE DE FREIN / BRAKE PAD - BRAKE SHOE

53

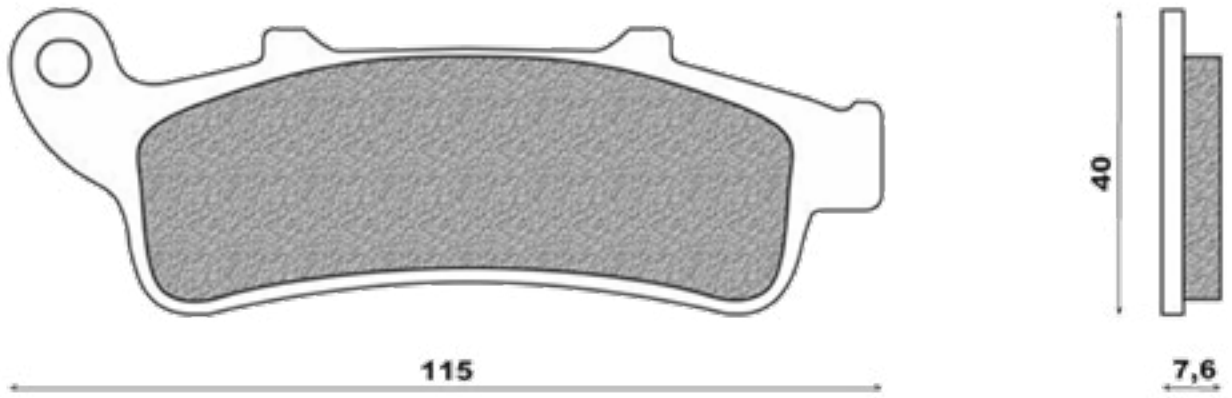

54

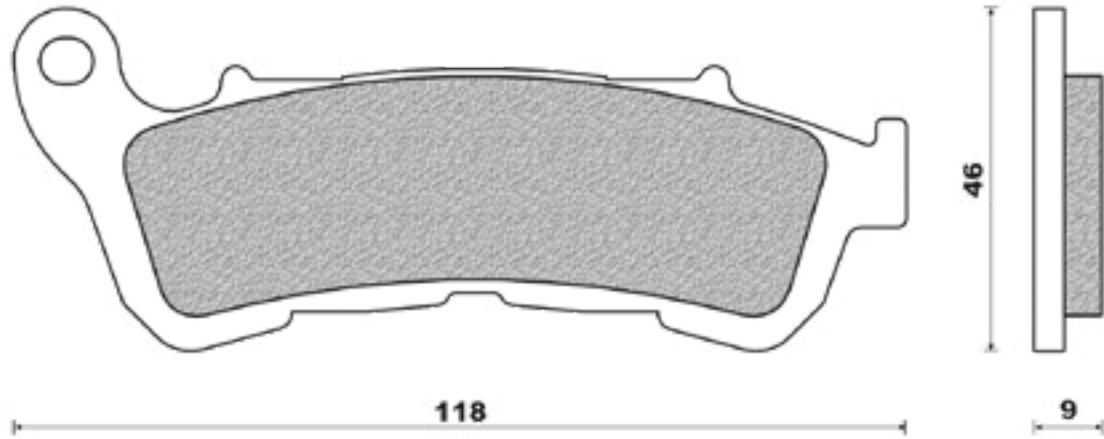

55

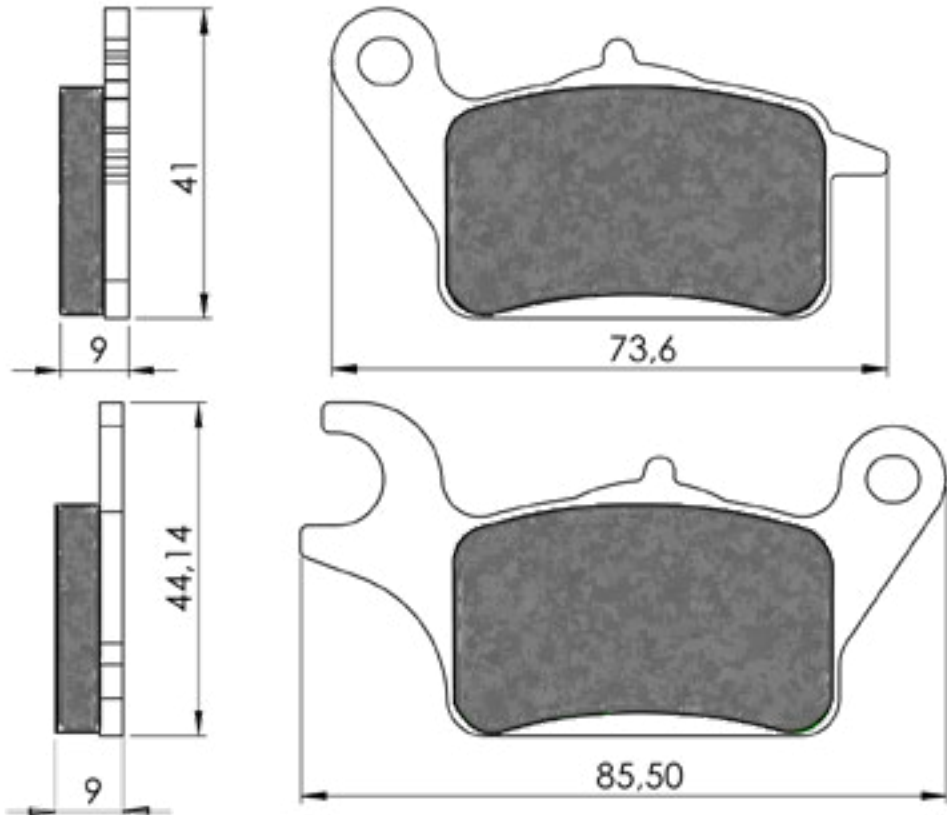

56

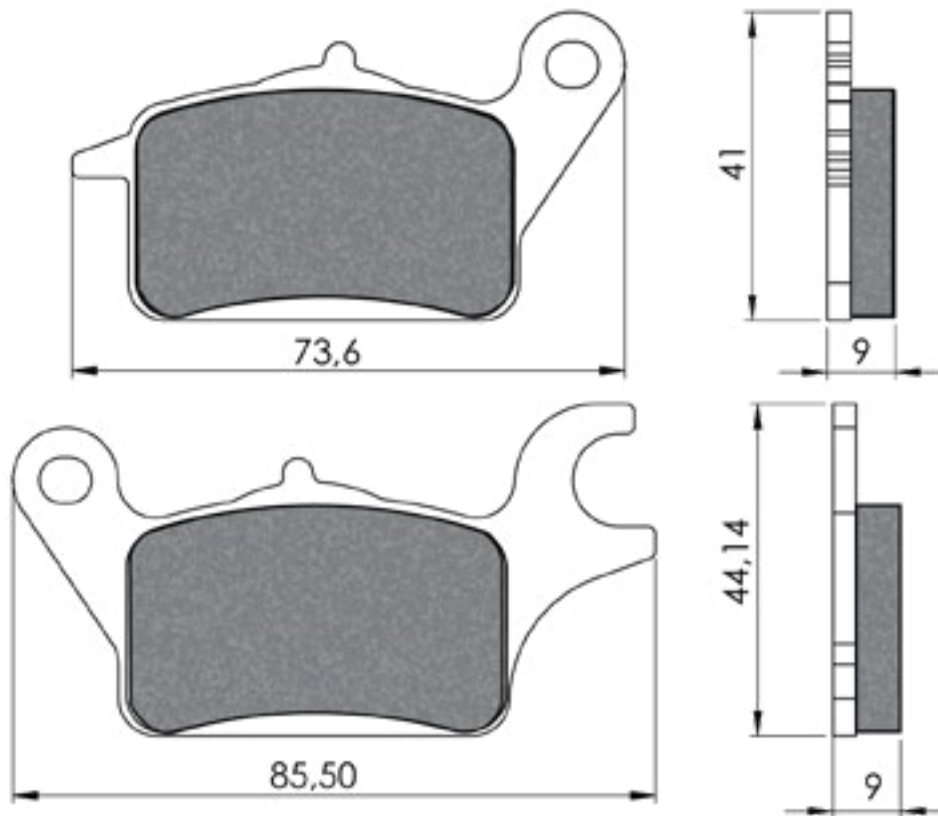

57

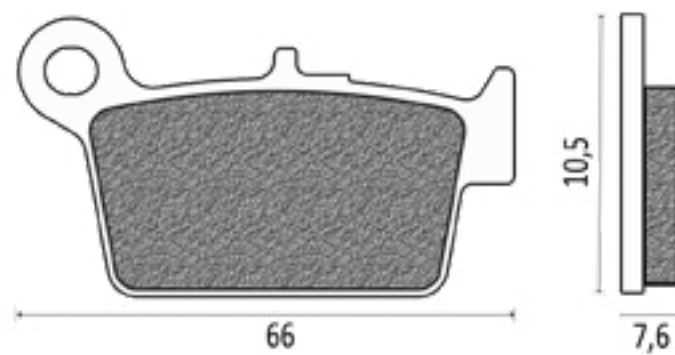

58

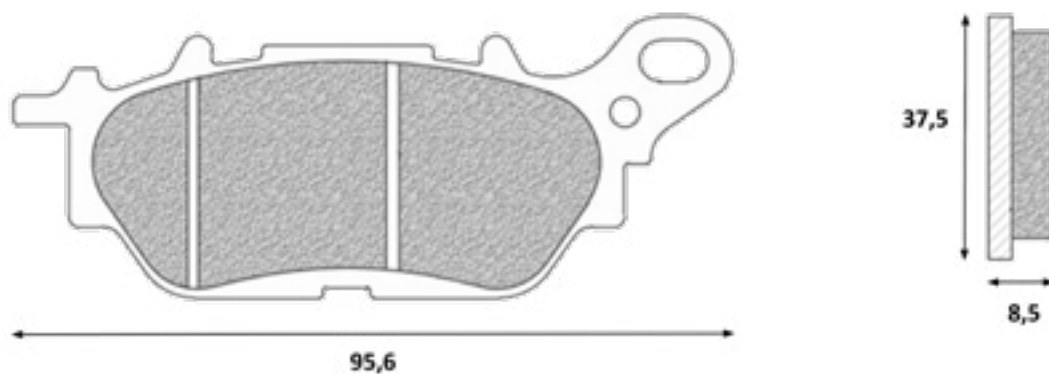
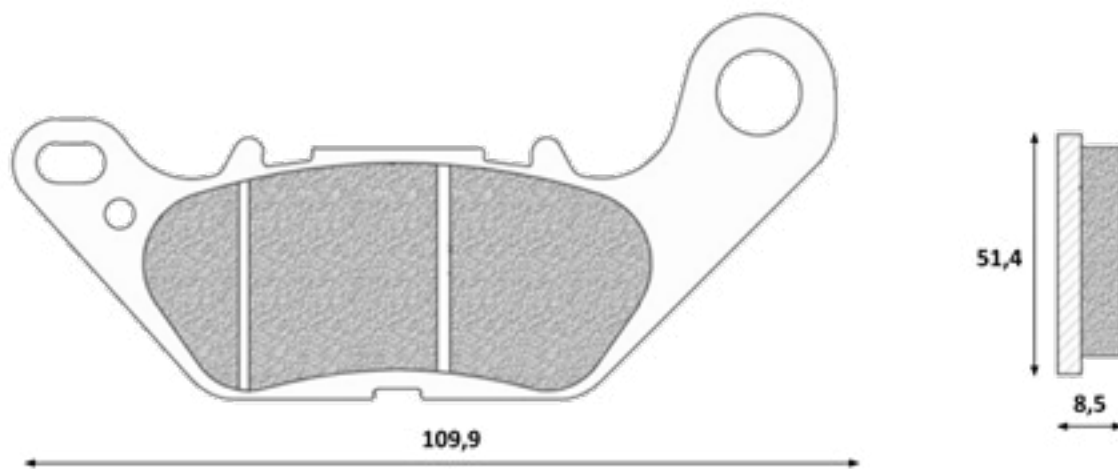

59

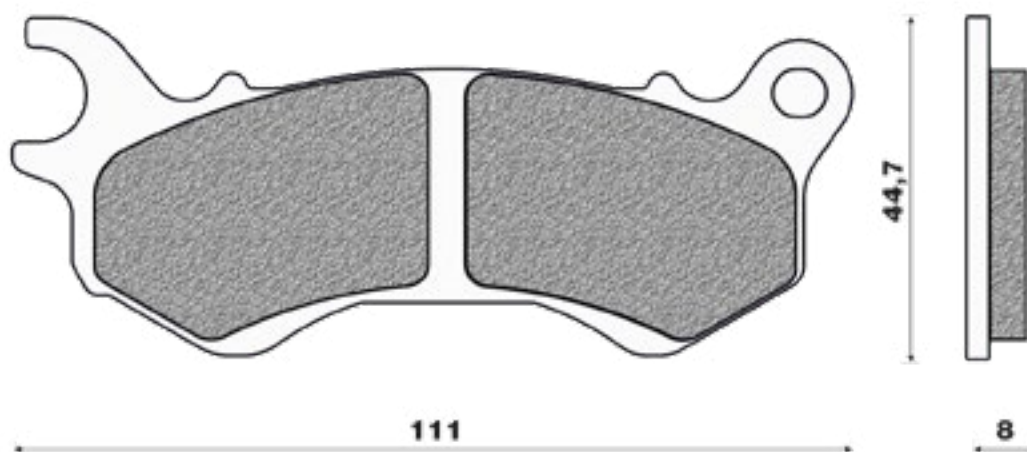
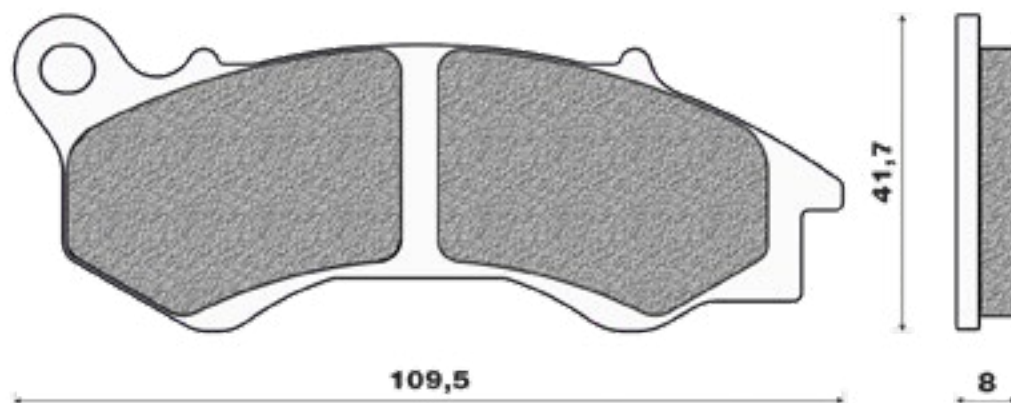

## PLAQUETTE DE FREIN - MÂCHOIRE DE FREIN / BRAKE PAD - BRAKE SHOE

60

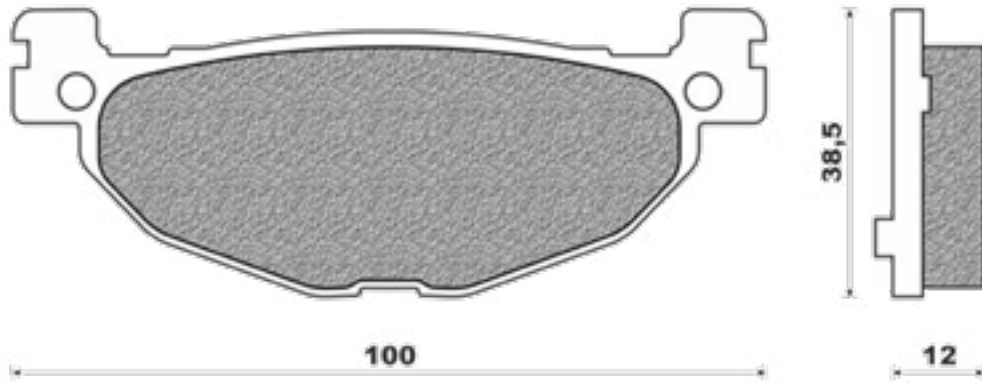

61

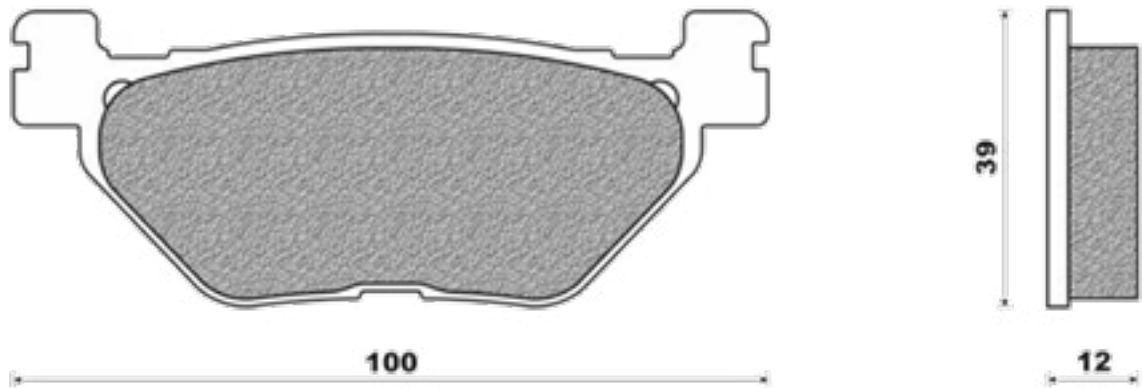

62

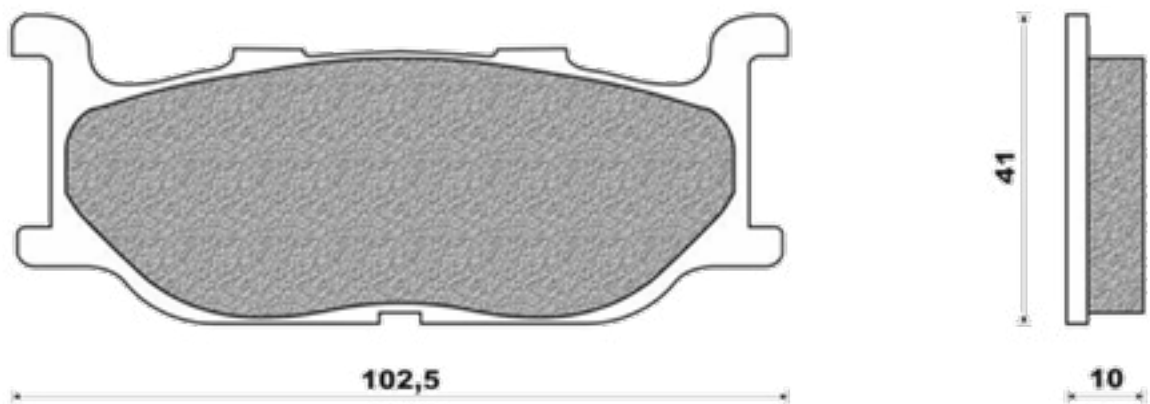

63

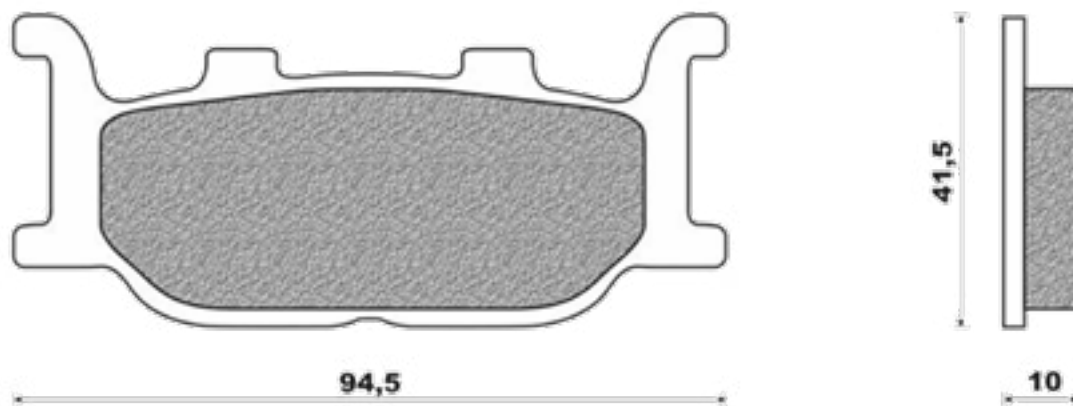

64

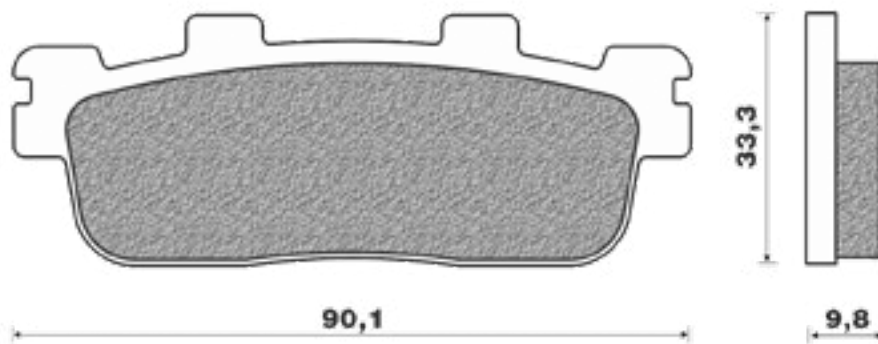

65

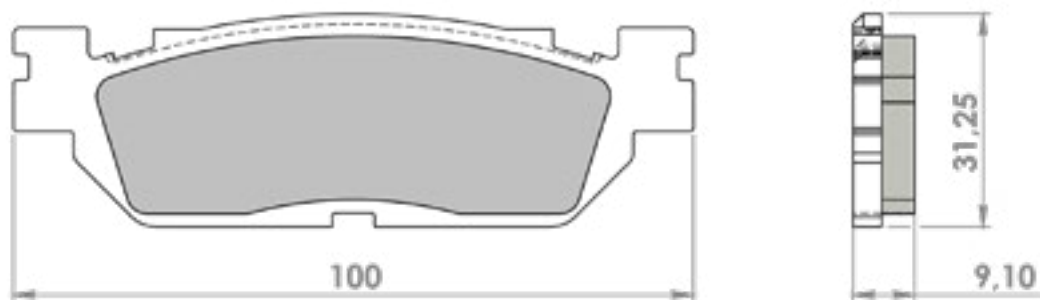

66

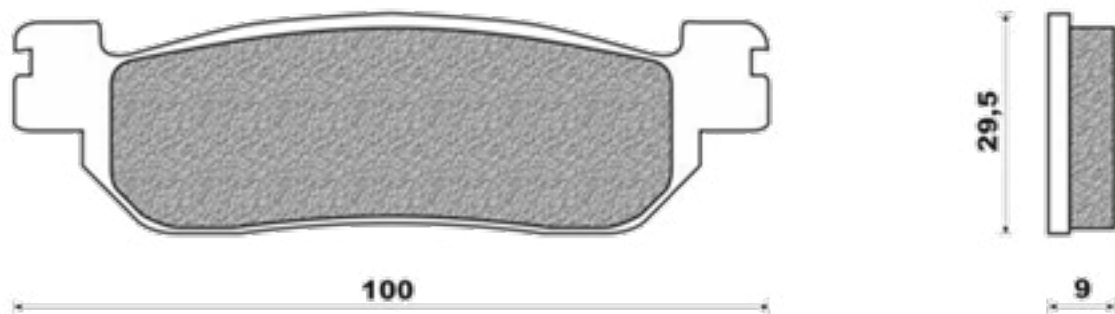

67

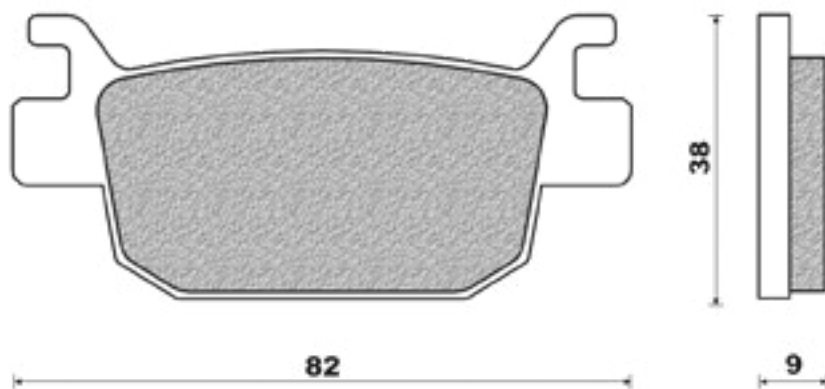

68

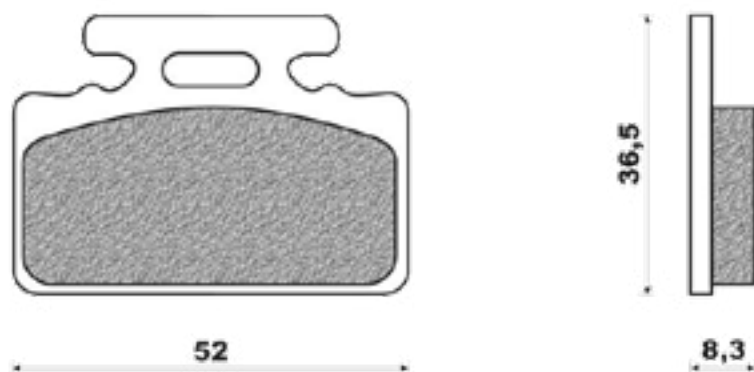

69

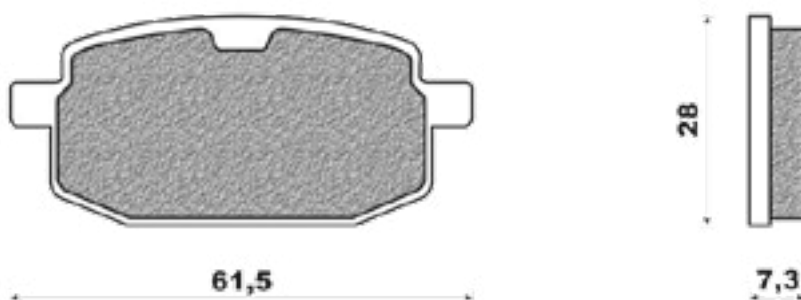



70

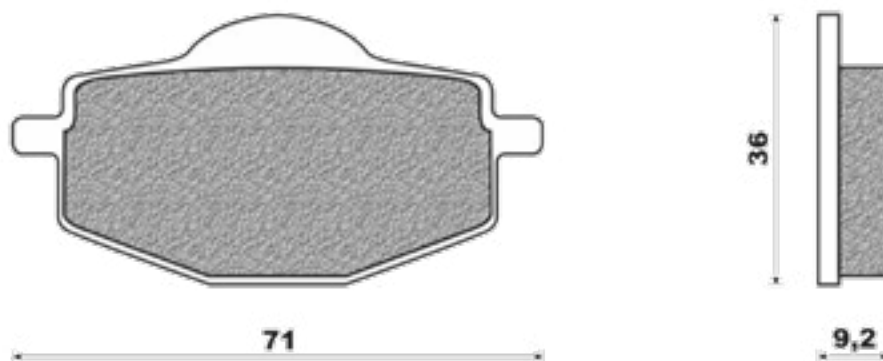

71

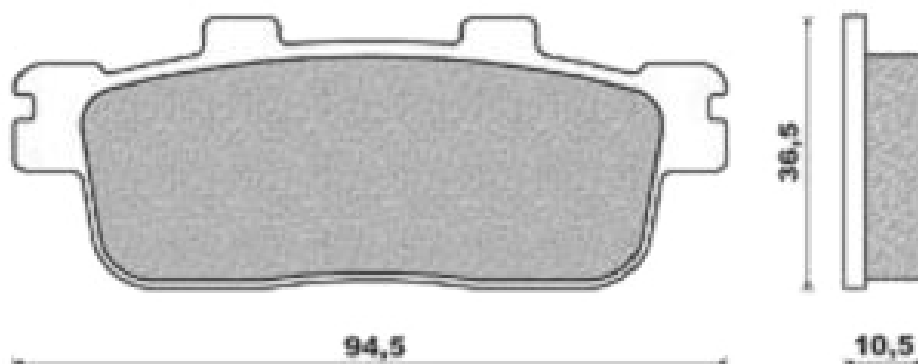

## TABLEAU RÉCAPITULATIF DES RÉFÉRENCES DE MÂCHOIRES

| N° schéma | MEHFREM | TEKNIX | DOPPLER | polini |
|-----------|---------|--------|---------|--------|
| A         | 484758  | 4246   | 493269  | 486848 |
| B         |         | 833    | 493266  |        |
| C         |         | 292877 |         |        |
| D         | 492541  | 479094 | 493265  |        |
| E         | 490599  |        |         |        |
| F         | 490602  |        |         |        |
| G         | 490598  |        |         |        |
| H         |         | 481759 |         |        |
| I         | 492542  | 449771 |         |        |
| J         |         | 479774 |         |        |
| K         | 492539  |        |         | 486849 |

| N° schéma | MEHFREM | TEKNIX | DOPPLER | polini |
|-----------|---------|--------|---------|--------|
| L         | 479804  |        | 493267  | 486851 |
| M         |         | 265157 |         |        |
| N         | 485501  |        |         |        |
| O         | 485293  |        |         |        |
| P         | 490597  |        |         |        |
| Q         | 490600  |        |         |        |
| R         | 484936  | 836    | 493268  |        |
| S         | 498275  |        |         |        |
| T         | 498276  |        |         |        |
| U         | 498277  |        |         |        |

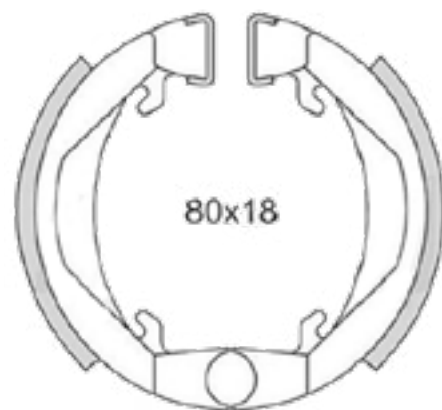
**A****B****C****D****E****F**

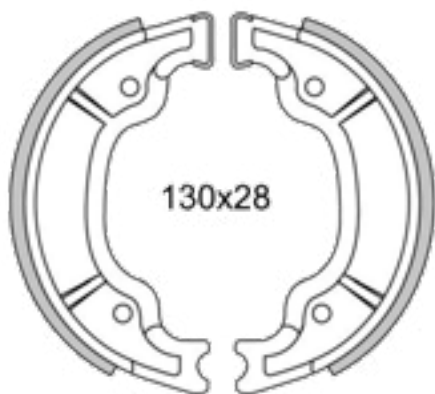

**G**

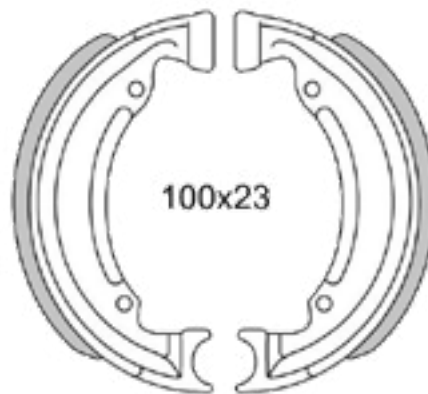

**H**



**I**



**J**



**K**

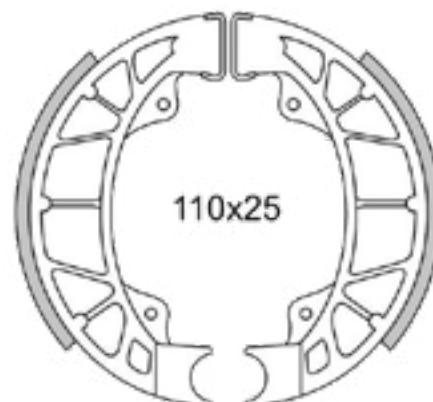

**L**

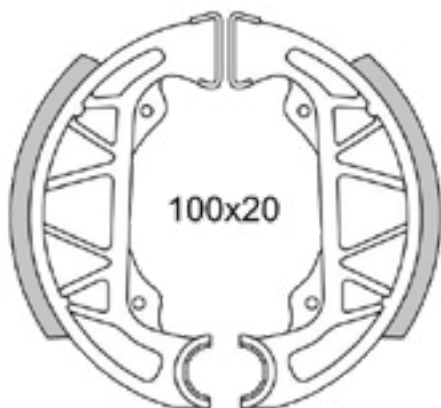
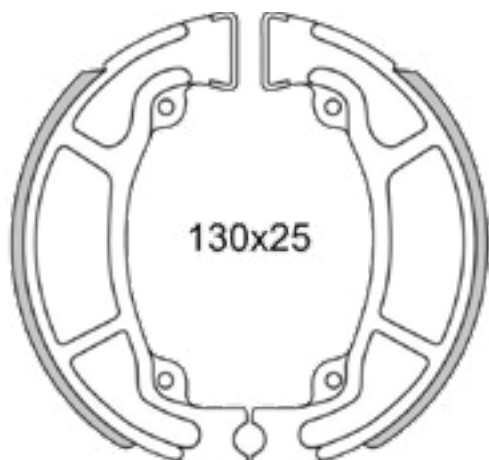
**M****N****O****P**

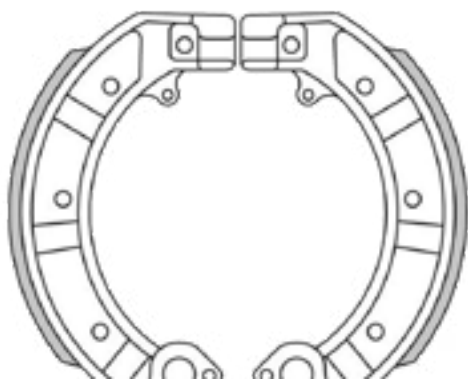

**Q**

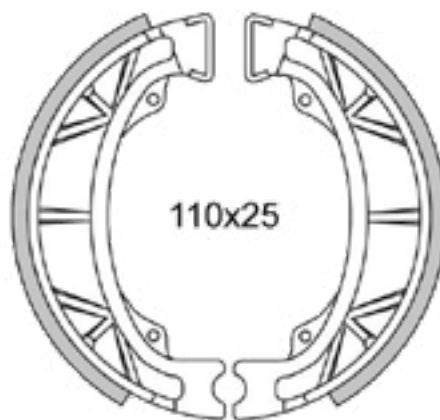

**R**



**S**



**T**



**U**



↳ **INFO + :**

Retrouvez les vis **page 652.**



## TRANSMISSION FREIN ARRIÈRE

|   |   |   |   |
|---|---|---|---|
|    |    |     |  |
| <b>188607</b>   | <b>458205</b>   | <b>482749</b>   | <b>440122</b>   |
| BOOSTER   BW'S ->2003 lubrifié  | BOOSTER   BW'S 2004->   STUNT   SLIDER  | BOOSTER NEXT   ROCKET lubrifié  | OVETTO   NEOS   |
|    |    |     |  |
| <b>487254</b>   | <b>460076</b>   | <b>288905</b>   | <b>210133</b>   |
| KISBEE 4 temps  | LUDIX 1800mm  | SPEEDFIGHT 1 et 2   TREKKER   VIVACITY 1 et 2   BUXY                                  | TYPHOON ->2011   NRG   STROM   NTT lubrifié   |
|    |    |     |  |
| <b>482196</b>   | <b>482332</b>   | <b>482197</b>   | <b>210148</b>   |
| ZIP 2 temps   | KEEWAY   CPI  | SCOOTER CHINOIS   V CLIC 1990mm   | SR50 lubrifié   |
|  |  |  |   |
| <b>252567</b>   | <b>458206</b>   | <b>482358</b>   |   |
| STALKER lubrifié  | STUNT   SLIDER lubrifié   | SYM ORBIT 50CC  |   |



## TRANSMISSION FREIN AVANT

|   |   |   |
|---|---|---|
|  |  |  |
| <b>487255</b>   | <b>188615</b>   | <b>460075</b>   |
| BOOSTER ONE 2013->   BW'S EASY 2013->   | BOOSTER   BW'S lubrifié ->1995  | LUDIX ONE   |



### EMBOUT DE CÂBLE

**332397**

fileté pour transmission frein



# CÂBLE ET GAINÉ / CABLE AND SHEATH



## TRANSMISSION CÂBLE GAZ



|   |   |  |   |
|---|---|--|---|
|      |    |    |    |
| <b>482750</b><br>BOOSTER   BW'S 2004-> complet  | <b>482331</b><br>BOOSTER   ROCKET   NITRO 2004->                                    | <b>188634</b><br>BOOSTER SPIRIT   STUNT   ROCKET complet                             | <b>325054</b><br>NG   ROCKET   NITRO 2004->   BOOSTER 1999-> partie 1                 |
|      |    |    |    |
| <b>290313</b><br>NITRO   AEROX ->2004 complet, partie 1 et 2                          | <b>466787</b><br>NITRO   AEROX ->2004 primaire, partie 1                            | <b>459957</b><br>OVETTO   NEOS complet   | <b>451404</b><br>OVETTO   NEOS seul, transmission primaire                            |
|     |   |   |   |
| <b>325069</b><br>ROCKET   NITRO 2004->   BOOSTER 1999->2004 partie 2                  | <b>210061</b><br>BUXY   ZENIT   SPEEDAKE  | <b>489389</b><br>KISBEE 2 temps  | <b>489390</b><br>KISBEE 4 temps   |
|    |  |  |  |
| <b>460046</b><br>LUDIX ONE  | <b>288897</b><br>SPEEDFIGHT   | <b>292976</b><br>TREKKER   SQUAB   TKR   | <b>210076</b><br>TYPHOON   NRG ->2004 partie haute                                    |
|    |  |  |  |
| <b>486398</b><br>ZIP 50 2 temps partie supérieur                                      | <b>483059</b><br>ZIP 50 4 temps   | <b>482752</b><br>CPI   KEEWAY complet  | <b>482394</b><br>KYMCO AGILITY 50/125   |
|    |  |   |   |
| <b>482754</b><br>SCOOTER CHINOIS 1990mm complet                                       | <b>210087</b><br>SR50   | <b>252541</b><br>STALKER   ICE partie 1  | <b>458194</b><br>STUNT   SLIDER seul, partie 1  |
|  |   |  | <b>482753</b><br>SCOOTER CHINOIS 1920mm complet                                       |



### TRANSMISSION CÂBLE STARTER

219585 BOOSTER | STUNT | NITRO partie 2 au carbu



### TRANSMISSION D'EMBRAYAGE



482395

GPR 50 2004-> | RS50  
2004->2010



376197

SENDA EURO 2



482357

SENDA EURO 3 2006-> | APRILIA  
SX 2006->



458203

X-LIMIT | DT50 R 2003->



283281

XP6 | XPS



375964

XP6 | XPS | SMT | XP7 | NK7



494279

RIEJU RS2



490435

RIEJU 50 MRT



492199

BETA RR50



377020

RS50 1995->2005



492200

SHERCO SE-R | SM-R



376100

SUZUKI RMX | SMX



290328

X-POWER | TZR 50  
->2003

Sélection  
**CGN**

### CÂBLE DE FREIN, EMBRAYAGE

|        |   |       |        |             |
|--------|---|-------|--------|-------------|
| 6527   | 8x8   | 2.25m | 18/10e | boîte de 15 |
| 6526   | 8x8   | 2.50m | 20/10e | boîte de 10 |
| 6528   | 9x9   | 2.50m | 23/10e | boîte de 10 |
| 487657 | universel livré avec serre-câble                          | 2.00m |        | x1          |
| 486932 | universel livré avec kit serre câble et barillet 9 pièces | 2.00m |        | x2          |



6527



487657



486932



### TRANSMISSION FREIN ARRIÈRE















283277 X-LIMIT | DT50 R ->2003 lubrifié







## CÂBLE DE GAZ

|   |   |  |  |
|---|---|--|--|
|    |    |    |   |
| <b>376148</b><br>DERBI GPR 50 1997->2003   GP50                                     | <b>376171</b><br>DERBI SENDA ->1999   | <b>376167</b><br>DERBI SENDA 2000->2010  | <b>482356</b><br>DERBI SENDA 2010->  |
|    |    |    |   |
| <b>376004</b><br>X-LIMIT   DT50 R ->2003  | <b>458201</b><br>X-LIMIT   DT50 R 2004->2008  | <b>482355</b><br>X-LIMIT   DT50 R 2008->   | <b>335957</b><br>X-POWER   TZR 50  |
|   |   |   |  |
| <b>329121</b><br>XP6 D5   | <b>375950</b><br>XP6 T   SM D6 poignée domino                                       | <b>490434</b><br>RIEJU 50 MRT  | <b>376095</b><br>RIEJU RMX 50  |
|  |  |  |  |
| <b>492198</b><br>BETA RR50  | <b>335946</b><br>RS50 1995->  | <b>492201</b><br>SHERCO SE-R   SM-R  |  |

Sélection  
**CGN**

### CÂBLE UNIVERSEL

|               |  |       |
|---------------|--|-------|
| <b>487657</b> | câble embrayage livré avec serre-câble x1                              | 2.00m |
| <b>486932</b> | câble gaz/embrayage livré avec kit serre-câble et barillet 9 pièces x2 | 2.00m |
| <b>484560</b> | câble gaz universel livré avec serre-câble                             | 2.50m |





**INFO + :**

Retrouvez les serre-câbles **page 653.**



## TRANSMISSION DE FREIN

**333738** avant FOX | FXR

**333742** arrière 103 FOX | FXR



333738



333742



## TRANSMISSION DE GAZ

**437932** 103 FOX | FXR



*Transfil*

## CÂBLE DE FREIN

|             |               |       |        |             |
|-------------|---------------|-------|--------|-------------|
| <b>6519</b> | 103 8x8       | 1.20m | 18/10e | boîte de 25 |
| <b>6520</b> | 103 8x8       | 1.20m | 18/10e | boîte de 25 |
| <b>6523</b> | MBK 51   CIAO | 1.20m | 18/10e | boîte de 25 |
| <b>6524</b> | MBK 51   CIAO | 1.80m | 18/10e | boîte de 25 |
| <b>6525</b> | MBK 51   CIAO | 2.25m | 18/10e | boîte de 15 |



6519



6520



6523



6524



6525

## CÂBLE DE GAZ (X25)

|               |                     |       |     |        |                 |
|---------------|---------------------|-------|-----|--------|-----------------|
| <b>6540</b>   | 103                 | 1.20m | 5x7 | 12/10e | <i>Transfil</i> |
| <b>6541</b>   | 103                 | 2.00m | 5x7 | 12/10e | <i>Transfil</i> |
| <b>6536</b>   | MBK 51              | 1.20m | 3x4 | 12/10e | <i>Transfil</i> |
| <b>6538</b>   | MBK 51              | 2.50m | 3x4 | 12/10e | <i>Transfil</i> |
| <b>479341</b> | MBK 51   103   CIAO | 2m    | 3x3 | 12/10e | <i>Transfil</i> |
| <b>480346</b> | CIAO   MBK 51   103 | 2.50m | 3x3 | 12/10e | <b>VELOX</b>    |



6540



6541



6536



6538



479341



480346

*Transfil*

## CÂBLE DE DÉCOMPRESSEUR (X25)

**6545** 103 boule 5x7 1.20m 12/10e

**6542** MBK 51 | CIAO boule 5x9 1.20m 12/10e



6545



6542



## CÂBLE MOTOCULTURE

**492597** tondeuse tête en "S" 1.90m 18/10ème



## DÉDOUBLEUR CÂBLE DE GAZ/POMPE À HUILE

**495180** Ø6.25 course 36mm

**495181** Ø6.8 course 36mm

**495182** Ø6.8 course 41mm

**495183** multiplicateur de course ratio 1.33



495180

495181



495182

495183



## GAINÉ

|               |              |    |     |     |
|---------------|--------------|----|-----|-----|
| <b>6567</b>   | chrome       | Ø5 | 25m | 4mm |
| <b>177095</b> | lazer bleu   | Ø5 | 25m | 4mm |
| <b>196830</b> | lazer chrome | Ø5 | 25m | 4mm |



6567



177095



196830



## GAINÉ

|             |           |     |        |                      |
|-------------|-----------|-----|--------|----------------------|
| <b>6561</b> | noir      | 25m | 4mm    | <i>Transfil</i>      |
| <b>6562</b> | gris      | 25m | 4mm    | <i>Transfil</i>      |
| <b>6559</b> | blanc     | 25m | 4mm    | <i>Transfil</i>      |
| <b>6558</b> | bleu      | 25m | 4mm    | <i>Transfil</i>      |
| <b>6560</b> | rouge     | 25m | 4mm    | <i>Transfil</i>      |
| <b>6563</b> | vert anis | 25m | 4mm    | <i>Transfil</i>      |
| <b>6580</b> | noir      | 15m | 32/10e | <b>Sélection CGN</b> |



6561



6562



6559



6558



6560



6563



6580

## CÂBLE ET GAINÉ / CABLE AND SHEATH



**ETRIER DE FREIN HYDRAULIQUE**
**487200**SPEEDFIGHT 1 et 2 | TREKKER |  
125 ELYSTAR arrière**487198**

XP6 | XPS avant

**487204**

X-POWER | TZR 2004-&gt; arrière

**487201**DERBI SENDA DRD EDITION et  
AR DRD EDITION | X RA avant**487202**DERBI SENDA DRD PRO | RA-  
CING 50 | 125 | MRT PRO | MRX  
avant**487197**DERBI SENDA | BETA | SMT  
avant**487199**ZENITH | LUDIX | ELYSTAR |  
VIVACITY | SPEEDFIGHT | TKR  
avant**487206**DERBI SENDA DRD PRO | EVO |  
RACING arrière**487205**

DERBI SENDA X-TREME 50 arrière

**491495**X-POWER | TZR | BETA RR50 2000->2011  
avant**492264**XR7 | NK7 | RS4 | DERBI GPR 2006->2010 |  
DRD PRO | SENDA EVO avant**ETRIER DE FREIN HYDRAULIQUE****484176**

AGILITY KYMCO 50 avant

**484170**

V CLIC | SCOOTER CHINOIS avant

**484174**ZIP PIAGGIO 50 2009-> | VESPA LX | AR F12  
et F1 avant**480397**

MBK | YAMAHA | PIAGGIO | KEEWAY Brembo avant avec plaquettes

**480396**

PEUGEOT | DERBI SENDA avant avec plaquettes

**496094**

SPEEDFIGHT 1 et 2 | 125 ELYSTAR arrière

**496095**

SYM FIDDLE | ORBIT avant

# CÂBLE ET GAINÉ / CABLE AND SHEATH



## EPINGLE, RESSORT

**489834** maintien de plaquette de frein



## VIS DE PURGE

**487193** M10 pas 1.00mm

**487195** M6 pas 1.00mm

**487196** M8x125 pas 1.25mm



487193



487196



## VIS DE PURGE

**489892** M8x100 pas 1.00mm



## VIS BANJO ÉTRIER DE FREIN / MAÎTRE CYLINDRE

**489835** M10x22 pas 1.25mm



## JOINT ÉTRIER MAÎTRE CYLINDRE (X1)

**483804** Ø10x14mm | cuivre



### ↳ INFO + :

Retrouvez le liquide de frein à partir de la **page 599**.

## AIP MAÎTRE CYLINDRE



**487187**

SPEEDFIGHT 1 | DT50 | X RACE  
->2005 | SENDA  
avant



**487188**

SQUAB | ZENITH | ELYSTAR |  
LUDIX | JET  
avant



**487180**

DERBI DRD PRO | EDITION | X-  
RACE SM  
avant



**487181**

DERBI X-TREME SM | R  
avant



**487185**

RIEJU MRT | TANGO | SPIKE |  
RMX | MRX  
avant



**487186**

TZR | X-POWER  
avant



**487183**

X LIMIT | DT50  
avant



**487192**

BETA | TZR | X POWER | SUZUKI  
RMX | RS1  
arrière

# CÂBLE ET GAINÉ / CABLE AND SHEATH



## MAÎTRE CYLINDRE



**487191**

DERBI GPR NUDE 50 | 125 |  
RIEJU MRX | SMX | XP6  
arrière



**487190**

DERBI GPR | RIEJU RS1 | DT50 |  
X-LIMIT  
arrière



**487189**

DERBI SENDA | DRD  
arrière



## MAÎTRE CYLINDRE



**482120**

KYMCO AGILITY côté droit  
avant



**496096**

type DERBI SENDA universel  
avant



**482121**

droit  
avant

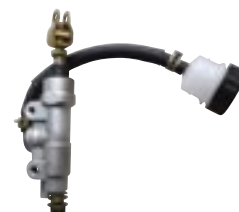

**482124**

DERBI SENDA avec bocal et  
durite  
arrière



**491739**

universel  
arrière



**482122**

gauche  
arrière



## MAÎTRE CYLINDRE UNIVERSEL RÉSERVOIR PLASTIQUE

### Droit

- 490079** bouchon noir
- 490078** bouchon rouge
- 493392** bouchon argent
- 493391** bouchon or

### Gauche

- 493396** bouchon noir
- 493397** bouchon rouge
- 493395** bouchon argent
- 493394** bouchon or



493396

490079



493397

490078



493395



493392



493394



493391



**TUN'R**

## BOCAL MAÎTRE CYLINDRE UNIVERSEL

|        |                   |                |
|--------|-------------------|----------------|
| 490085 | bouchon alu noir  | sortie dessous |
| 490084 | bouchon alu or    | sortie dessous |
| 490083 | bouchon alu rouge | sortie dessous |



Sélection  
**CGN**

## BOCAL MAÎTRE CYLINDRE UNIVERSEL

|        |                 |
|--------|-----------------|
| 478429 | sortie dessous  |
| 480683 | sortie inclinée |



**IP**

## KIT RÉPARATION MAÎTRE CYLINDRE DE FREIN

|        |                        |
|--------|------------------------|
| 487182 | Ø11mm pour frein avant |
|--------|------------------------|



Sélection  
**CGN**

## VIS INOX DE COUVERCLE/CAPOT MAÎTRE CYLINDRE DE FREIN (X1)

|        |        |
|--------|--------|
| 483092 | 4x12mm |
|--------|--------|



**TEKNEX**

## FLASQUE DE FREIN

|        |  |         |
|--------|--|---------|
| 480982 | 103 PGT AM Ø80mm avec mâchoires type Leleu | arrière |
| 480983 | MBK 51 moyeu Ø80mm nu sans mâchoire        | arrière |
| 496079 | 103 PGT nu sans mâchoire type Leleu        | avant   |



# PNEUMATIQUE

|                               |     |
|-------------------------------|-----|
| Capuchon de valve _____       | 568 |
| Chambre à air _____           | 565 |
| Codes de vitesse/ICV _____    | 536 |
| Equivalences dimensions _____ | 535 |
| Pièces détachées roues _____  | 571 |
| Pneu Scooter _____            | 537 |
| <i>Michelin</i> _____         | 541 |
| <i>Continental</i> _____      | 544 |
| <i>Deli Tire</i> _____        | 546 |
| <i>Mitas</i> _____            | 547 |
| <i>Heidenau</i> _____         | 549 |
| <i>Hutchinson</i> _____       | 550 |
| Pneu Moto _____               | 551 |
| Pneu Cyclo _____              | 562 |



## ÉQUIVALENCES DIMENSIONS



### ÉQUIVALENCE DES DIMENSIONS PNEUS SCOOTERS NON RADIAUX

| TOUS TYPES DE PNEUS À ARCHITECTURE DIAGONALE |        |                      |
|--|--------|----------------------|
| dimensions millimétriques                    |        | dimensions en pouces |
| 2  | ←————→ | 1,35                 |
| 2-1/4  | ←————→ | 1,5                  |
| 2-1/2  | ←————→ | 1,5                  |
| 2-3/4  | ←————→ | 1,85                 |
| 3  | ←————→ | 1,85                 |
| 80/80  | ←————→ | 2.75                 |
| 80/90  | ←————→ | 2.75   3.00          |
| 90/90  | ←————→ | 3.00   3.25   3.60   |
| 100/90                                       | ←————→ | 3.50   4.10          |
| 110/90                                       | ←————→ | 4.00   4.10   4.60   |
| 120/80                                       | ←————→ | 4.25   4.50   4.60   |
| 120/90                                       | ←————→ | 4.25   4.50          |
| 130/80                                       | ←————→ | 4.50   4.60   5.10   |
| 130/90                                       | ←————→ | 4.50   4.60   5.11   |
| 140/80                                       | ←————→ | 4.50   5.10   5.50   |
| 140/90                                       | ←————→ | 5.10   5.50          |



### ÉQUIVALENCE DES DIMENSIONS PNEUS MOTO ROUTE NON RADIAUX

|         | Pouces  |             | Millimètres |           |
|---------|---------|-------------|-------------|-----------|
|         |         | Série basse | Série 90    | Série 80  |
| 16"     | 3.25-16 |             | 110/80-16   | 100/90-16 |
|         | 3.50-16 | 4.60-16     | 120/80-16   | 110/90-16 |
|         | 3.50-16 |             |             | 120/90-16 |
|         | 5.00-16 | 5.10-16     | 150/80-16   | 130/90-16 |
| 17"     | 2.50-17 | 3.10-17     |             | 80/90-17  |
|         | 2.75-17 | 3.10-17     |             | 80/90-17  |
|         | 4.25-17 |             | 130/80-17   | 120/90-17 |
|         | 4.50-17 | 5.10-17     | 140/80-17   | 130/90-17 |
| 18"     | 2.50-18 |             |             |           |
|         | 2.75-18 | 3.10-18     |             | 80/90-18  |
|         | 3.00-18 | 3.10-18     |             | 80/90-18  |
|         | 3.25-18 | 3.60-18     | 100/80-18   | 90/90-18  |
|         | 3.50-18 | 4.10-18     | 110/80-18   | 100/90-18 |
|         | 3.75-18 | 4.10-18     | 110/80-18   | 100/90-18 |
|         | 4.00-18 | 4.25/85-18  | 120/80-18   | 110/90-18 |
|         | 4.00-18 | 4.60-18     | 130/80-18   | 120/90-18 |
| 4.25-18 |         | 140/80-18   | 130/90-18   |           |
| 19"     | 3.00-19 |             |             |           |
|         | 3.25-19 |             |             | 90/90-19  |
|         | 3.50-19 | 4.10-19     |             | 100/90-19 |
|         | 3.50-19 |             |             | 110/90-19 |
| 21"     | 2.75-21 |             |             | 80/90-19  |
|         | 3.00-21 |             |             | 90/90-21  |



## CODES DE VITESSE/ICV

### MARQUAGE

| Taille du pneu | Indice de charge | Indice de vitesse | Pneu tubeless | Profil |
|----------------|------------------|-------------------|---------------|--------|
| 130/90 - 10    | 70               | J                 | TL            | SC101  |

### CODES DE VITESSE

| Indice de vitesse km/h | km/h | Indice de vitesse km/h | km/h | Indice de vitesse km/h | km/h | Indice de vitesse km/h | km/h |
|------------------------|------|------------------------|------|------------------------|------|------------------------|------|
| A1                     | 5    | B                      | 50   | K                      | 110  | S                      | 180  |
| A2                     | 10   | C                      | 60   | L                      | 120  | T                      | 190  |
| A3                     | 15   | D                      | 65   | M                      | 130  | U                      | 200  |
| A4                     | 20   | E                      | 70   | N                      | 140  | H                      | 210  |
| A5                     | 25   | F                      | 80   | P                      | 150  | V                      | 240  |
| A6                     | 30   | G                      | 90   | Q                      | 160  | X                      | 270  |
| A7                     | 35   | J                      | 100  | R                      | 70   | Y                      | 300  |
| A8                     | 40   |                        |      |                        |      |                        |      |







### INDICES DE CAPACITÉ DE CHARGE (ICV)

| Indice | kg   | Indice | kg  | Indice | kg  | Indice | kg   |
|--------|------|--------|-----|--------|-----|--------|------|
| 0      | 45   | 30     | 106 | 60     | 250 | 90     | 600  |
| 1      | 46.2 | 31     | 109 | 61     | 257 | 91     | 615  |
| 2      | 47.5 | 32     | 112 | 62     | 265 | 92     | 630  |
| 3      | 48.7 | 33     | 115 | 63     | 272 | 93     | 650  |
| 4      | 50   | 34     | 118 | 64     | 280 | 94     | 670  |
| 5      | 51.5 | 35     | 121 | 65     | 290 | 95     | 690  |
| 6      | 53   | 36     | 125 | 66     | 300 | 96     | 710  |
| 7      | 54.5 | 37     | 128 | 67     | 307 | 97     | 730  |
| 8      | 56   | 38     | 132 | 68     | 315 | 98     | 750  |
| 9      | 58   | 39     | 136 | 69     | 325 | 99     | 775  |
| 10     | 60   | 40     | 140 | 70     | 335 | 100    | 800  |
| 11     | 61.5 | 41     | 145 | 71     | 345 | 101    | 825  |
| 12     | 63   | 42     | 150 | 72     | 355 | 102    | 850  |
| 13     | 65   | 43     | 155 | 73     | 365 | 103    | 875  |
| 14     | 67   | 44     | 160 | 74     | 375 | 104    | 900  |
| 15     | 69   | 45     | 165 | 75     | 387 | 105    | 925  |
| 16     | 71   | 46     | 170 | 76     | 400 | 106    | 950  |
| 17     | 73   | 47     | 175 | 77     | 412 | 107    | 975  |
| 18     | 75   | 48     | 180 | 78     | 425 | 108    | 1000 |
| 19     | 77.5 | 49     | 185 | 79     | 437 | 109    | 1030 |
| 20     | 80   | 50     | 190 | 80     | 450 | 110    | 1060 |
| 21     | 82.5 | 51     | 195 | 81     | 462 | 111    | 1090 |
| 22     | 85   | 52     | 200 | 82     | 475 | 112    | 1120 |
| 23     | 87.5 | 53     | 206 | 83     | 487 | 113    | 1150 |
| 24     | 90   | 54     | 212 | 84     | 500 | 114    | 1180 |
| 25     | 92.5 | 55     | 218 | 85     | 515 | 115    | 1215 |
| 26     | 95   | 56     | 224 | 86     | 530 | 116    | 1250 |
| 27     | 97.5 | 57     | 230 | 87     | 545 | 117    | 1285 |
| 28     | 100  | 58     | 236 | 88     | 560 | 118    | 1320 |
| 29     | 103  | 59     | 243 | 89     | 580 | 119    | 1360 |



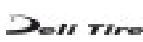



## MODÈLES DE PNEU TRAIL, CROSS ET ENDURO PAR TAILLE

|        |                                    |  |  |      |  |  |  |
|--------|------------------------------------|---|---|---|--|---|---|
| 8"     | 3.50                               | S83<br>320344   |   |   |  |   |   |
|        | 3.50                               |   |   |   | B13<br>495628<br>B13 CITY FLANC<br>BLANC<br>495629                                 |   |   |
|        | 4.00                               |   |   | S-223<br>460437   | B13<br>451992  |   |   |
| 9"     | 2.75                               | ACS<br>320363   |   |   |  |   |   |
| 10"    | 3.00                               | S1<br>493211<br>S83<br>465633   | TWIST<br>495900<br>CLASSIC<br>495899  | S-239<br>460425   |  |   |   |
|        | 3.50                               | CITY GRIP<br>WINTER<br>485321<br>S83<br>3634                                      | TWIST<br>495901<br>CLASSIC<br>493050  | S-236<br>460424   | MC18<br>451990<br>B14 SPORT<br>FLANC BLANC<br>482854                               |   |   |
|        | 90/90                              | CITY GRIP<br>496352<br>S1<br>3637   | TWIST<br>478944   | S-224<br>460426<br>S-220<br>480577  | MC13<br>451985   | PLANET<br>460844  |   |
|        | 90/100                             |   | TWIST<br>495906   |   |  |   |   |
|        | 100/80                             | CITY GRIP<br>491710<br>S1<br>3639   | TWIST<br>478946   | S-223<br>460423<br>SC-103<br>493603   | MC22<br>451993   | PLANET<br>460845  |   |
|        | 100/90                             | S1<br>363194  | TWIST<br>478947   | S-224<br>460427   | MC6<br>451999  |   |   |
|        | 110/80                             | S1<br>122484  | TWIST<br>478948   |   | MC6<br>452004  |   |   |
|        | 120/70                             | CITY GRIP<br>481917   | TWIST<br>478949   | S-224<br>460428<br>SC-103<br>476727   | MC22<br>458430   |   |   |
|        | 120/90                             | REGGAE<br>3642  | TWIST<br>478950   | S-224<br>460429<br>SC-101<br>460431<br>SC-106<br>481416                               | MC17 pavé<br>451982<br>MAXIMA SPORT<br>472391                                      | STARDUST<br>460835<br>KWARTER<br>451651   |   |
|        | 130/70                             | S1<br>210937  | TWIST<br>486803   |   |  |   |   |
| 130/90 | REGGAE<br>3643<br>BOPPER<br>227556 | REGGAE<br>3643<br>BOPPER<br>227556<br>TWIST<br>478951                             | S-224<br>460430<br>SC-101<br>460432<br>SC-106<br>481417                           | MC 32 M+S<br>spécial neige<br>482856<br>MC17 pavé<br>496747<br>MAXIMA SPORT<br>472392 | STARDUST<br>460836<br>KWARTER<br>451652  |   |   |
| 150/80 |                                    |   | SC-101<br>464834  | MC17 pavé<br>461373   |  | KWARTER<br>460843   |   |







MODÈLES DE PNEU TRAIL, CROSS ET ENDURO PAR TAILLE

|        |                                |    |               |           |                                      |    |  |
|--------|--------------------------------|---|--|--|--|---|---|
| 11"    | 110/70                         | CITY GRIP<br><b>481920</b>  | TWIST<br><b>478952</b>   | SC-103<br><b>476726</b>  |  |   |   |
|        | 120/70                         | CITY GRIP<br><b>493104</b>  |  |  |  |   |   |
| 12"    | 90/90                          | CITY GRIP<br><b>496353</b>  |  |  |  |   |   |
|        | 100/90                         | CITY GRIP<br><b>496354</b>  |  |  |  |   |   |
|        | 110/70                         | POWER PURE SC<br><b>484081</b>  | TWIST<br><b>486256</b>   | SC-102<br><b>480575</b>  | MC16<br><b>478689</b>  | K61<br><b>478275</b>  |   |
|        | 110/90                         | POWER PURE SC<br><b>481141</b><br>CITY GRIP<br><b>476690</b>  | TWIST<br><b>495902</b>   | URBAN GRIP<br>SC109<br><b>491200</b>   |  | K58 M+S hiver<br><b>492706</b>  |   |
|        | 120/70                         | POWER PURE SC<br><b>481143</b><br>CITY GRIP<br><b>476691</b> (51P)<br><b>476692</b> (51S)<br>CITY GRIP GT<br><b>484084</b><br>CITY GRIP<br>WINTER<br><b>485323</b><br>BOPPER<br><b>169435</b> | TWIST<br><b>478953</b><br>TWIST FLANC<br>BLANC<br><b>491152</b>                                | URBAN GRIP<br>SC109<br><b>491186</b><br>SC-102<br><b>460433</b><br>SC-106<br><b>481414</b> | MC 32 M+S<br>(agrée poste)<br>spécial neige<br><b>485025</b><br>MC19<br><b>451979</b><br>MAXIMA SPORT<br><b>472393</b> | NHS SLICK<br>COMPETITION*<br><b>476498</b><br>K66 M+S agrée<br>poste<br><b>479646</b> | STARDUST<br><b>460837</b>   |
|        | 120/80                         |   |  |  | MC19<br><b>479763</b>  |   |   |
|        | 130/70                         | POWER PURE SC<br><b>493205</b> (62P)<br><b>481149</b> (56P)<br>CITY GRIP<br><b>476694</b> (62P)<br><b>476693</b> (56P)<br>CITY GRIP<br>WINTER<br><b>485325</b><br>BOPPER<br><b>169440</b>     | TWIST RACE<br><b>478967</b><br>TWIST<br><b>478954</b><br>TWIST FLANC<br>BLANC<br><b>495903</b> | URBAN GRIP<br>SC109<br><b>491187</b><br>SC-102<br><b>460434</b><br>SC-106<br><b>481415</b> | MC 32 M+S<br>(agrée poste)<br>spécial neige<br><b>485026</b><br>MC16<br><b>451976</b><br>MAXIMA SPORT<br><b>472394</b> | K66 M+S agrée<br>poste<br><b>479647</b>   | FUNZY<br><b>173984</b><br>STARDUST<br><b>460838</b>                                 |
|        | 130/80                         |   |  |  | MC19<br><b>479901</b>  |   |   |
| 140/70 | POWER PURE SC<br><b>481151</b> | TWIST<br><b>495904</b>  | SC-102<br><b>460435</b>  |  |  |   |   |
| 110/70 | CITY GRIP<br><b>491689</b>     |   |  |  |  |   |   |
| 13"    | 110/90                         | POWER PURE SC<br><b>481142</b><br>CITY GRIP<br><b>476695</b>  | TWIST<br><b>478955</b>   | URBAN GRIP<br>SC109<br><b>491193</b>   |  |   |   |
|        | 120/70                         | POWER PURE SC<br>481144   |  |  |  |   |   |
|        | 130/60                         | POWER PURE SC<br><b>481148</b> (53P)<br><b>484030</b> (60P)<br>CITY GRIP<br>WINTER<br><b>493206</b>   | TWIST<br><b>478956</b>   | SC-102<br><b>460436</b>  | MC16<br><b>451981</b><br>MAXIMA SPORT<br><b>472395</b>   |   | PASEO<br><b>451647</b><br>STARDUST<br><b>460840</b>                                 |

## MODÈLES DE PNEU TRAIL, CROSS ET ENDURO PAR TAILLE

|     |  |                    |  |                       |  |  |                           |
|-----|---|---|---|---|---|---|---------------------------|
| 13" | 130/70  | POWER PURE SC<br><b>481150</b><br>CITY GRIP<br><b>476696</b>  | TWIST<br><b>495905</b>  | URBAN GRIP<br>SC109<br><b>491194</b><br>CITY GRIPPER<br>REAR SB124<br><b>480576</b>                     |   |   |                           |
|     | 130/90  |   |   |   | MC 32 M+S<br>spécial neige<br><b>482859</b>   |   |                           |
|     | 140/60  | POWER PURE SC<br><b>481152</b><br>CITY GRIP<br><b>476697</b>  | TWIST<br><b>478957</b>  | URBAN GRIP<br>SC109<br><b>491190</b><br>SC-102<br><b>461009</b>   | MC16<br><b>451986</b><br>MAXIMA SPORT<br><b>472396</b>                              |   | STARDUST<br><b>460841</b> |
|     | 150/70  | POWER PURE SC<br><b>465623</b><br>CITY GRIP<br><b>484088</b>  |   | URBAN GRIP<br>SC109<br><b>491197</b>  |   |   |                           |
| 14" | 80/80   |   |   | SB-108<br><b>464835</b>   | MC26<br><b>454971</b>   | K66 M+S agréé<br>poste<br><b>467532</b>   |                           |
|     | 80/90   |   |   | URBAN GRIP<br>SC109<br><b>496351</b>  |   |   |                           |
|     | 90/80   |   |   | URBAN GRIP<br>SC109<br><b>491199</b>  |   |   |                           |
|     | 90/90   | CITY GRIP<br><b>484087</b>  |   | URBAN GRIP<br>SC109<br><b>496452</b><br>SC-102<br><b>481803</b>   |   | K66 M+S agréé<br>poste<br><b>496054</b> (52P)<br><b>495780</b> (52P)                |                           |
|     | 100/70  |   |   | SB-108<br><b>465684</b>   | MC26<br><b>461497</b>   | K66 M+S agréé<br>poste<br><b>467533</b>   | METEOR<br><b>460847</b>   |
|     | 100/90  | CITY GRIP<br><b>484086</b>  |   | URBAN GRIP<br>SC109<br><b>496454</b><br>SC-102<br><b>481804</b>   |   |   |                           |
|     | 110/80  | CITY GRIP<br><b>484085</b><br>CITY GRIP<br>WINTER<br><b>493207</b>                                  |   | URBAN GRIP<br>SC109<br><b>496455</b><br>URBAN GRIP<br>SC109<br><b>496455</b><br>SB-108<br><b>465685</b> | MC 32 M+S<br>(agréé poste)<br>spécial neige<br><b>485024</b>                        | K66 M+S agréé<br>poste<br><b>467535</b>   |                           |
|     | 120/70  | CITY GRIP<br><b>476698</b> (55P)<br><b>476699</b> (55S)<br>PILOT POWER 3<br>RADIAL<br><b>493203</b> | TWIST<br><b>478958</b>  | URBAN GRIP<br>SC109<br><b>491189</b><br>SB-112<br><b>464836</b>   |   |   | PASEO<br><b>332158</b>    |
|     | 120/80  | POWER PURE SC<br><b>481147</b>  |   |   | MC28<br><b>459664</b>   |   |                           |
|     | 140/60  | CITY GRIP<br><b>476700</b> (64P)<br><b>476701</b> (64S)<br>CITY GRIP<br>WINTER<br><b>485326</b>     | TWIST<br><b>478959</b>  | URBAN GRIP<br>SC109<br><b>491191</b><br>SB-112<br><b>464837</b>   |   |   |                           |

MODÈLES DE PNEU TRAIL, CROSS ET ENDURO PAR TAILLE

|     |   |  |  |  |  |  |
|-----|--|---|---|--|---|---|
| 14" | 140/70<br>CITY GRIP<br><b>476702</b> (68S)<br><b>476703</b> (66P)<br><b>476704</b> (66S)<br>CITY GRIP WINTER<br><b>485327</b>  | TWIST<br><b>478960</b>  | URBAN GRIP<br>SC109<br><b>491188</b><br>SB-112<br><b>465686</b>                   |  |   |   |
|     | 150/70   | TWIST<br><b>478961</b>  |   |  |   |   |
|     | 160/60<br>PILOT ROAD 4<br>RADIAL<br><b>493204</b>  |   |   |  |   |   |
| 15" | 120/70<br>POWER PURE SC<br><b>481146</b><br>CITY GRIP<br><b>476705</b> (56P)<br><b>476706</b> (56S)<br>CITY GRIP WINTER<br><b>493044</b><br>PILOT ROAD 4<br>RADIAL<br><b>493047</b> (56H)<br><b>493045</b> (56H) | TWIST<br><b>478963</b>  | URBAN GRIP<br>SC109<br><b>491192</b>  |  |   |   |
|     | 130/80<br>POWER PURE SC<br><b>481153</b>   |   |   |  |   |   |
|     | 140/70<br>CITY GRIP<br><b>483705</b>   |   |   | MC28<br><b>477557</b>  |   |   |
|     | 160/60<br>PILOT POWER 3<br>RADIAL<br><b>493046</b> (67H)<br><b>493048</b> (67H)  |   |   |  |   |   |
|     | 80/80  |   |   |  | K66 M+S agréé<br>poste<br><b>467536</b>   |   |
|     | 90/80<br>CITY GRIP<br><b>484082</b><br>CITY GRIP WINTER<br><b>493208</b>   |   |   | URBAN GRIP<br>SC109<br><b>496453</b>   | MC 32 M+S<br>(agréé poste)<br>spécial neige<br><b>485023</b>                        | K66 M+S agréé<br>poste<br><b>467534</b>   |
|     | 100/80<br>CITY GRIP<br><b>476707</b><br>CITY GRIP WINTER<br><b>493209</b>  |   |   | URBAN GRIP<br>SC109<br><b>491195</b>   |   |   |
|     | 110/70<br>CITY GRIP<br><b>476708</b> (52P)<br><b>476709</b> (52S)  | TWIST<br><b>478964</b>  |   | URBAN GRIP<br>SC109<br><b>491198</b>   | MC 32 M+S<br>(agréé poste)<br>spécial neige<br><b>485027</b>                        | K66 M+S agréé<br>poste<br><b>479358</b>   |
|     | 110/80<br>CITY GRIP<br><b>476710</b>   |   |   |  |   |   |
|     | 120/70<br>CITY GRIP<br><b>483704</b>   |   |   |  |   |   |
|     | 120/80<br>CITY GRIP<br><b>476711</b> (60P)<br><b>493210</b> (60S)  |   |   | URBAN GRIP<br>SC109<br><b>491196</b>   |   |   |
|     | 130/70<br>CITY GRIP<br><b>476712</b>   |   |   |  |   |   |
|     | 140/70<br>CITY GRIP<br><b>476713</b> (65P)<br><b>476714</b> (65S)  | TWIST<br><b>478965</b>  |   |  |   |   |



## INFO +

Retrouvez les outils de montage et de réparation pneumatique **page 625**.



### POWER PURE SC

| Référence | Dimensions | Montage | ICV |     |
|-----------|------------|---------|-----|-----|
| 484081    | 12"        | 110/70  | TL  | 47L |
| 481141    | 12"        | 110/90  | TL  | 64P |
| 481143    | 12"        | 120/70  | TL  | 51P |
| 481149    | 12"        | 130/70  | TL  | 56P |
| 493205    | 12"        | 130/70  | TL  | 62P |
| 481151    | 12"        | 140/70  | TL  | 60P |
| 481142    | 13"        | 110/90  | TL  | 56P |
| 481144    | 13"        | 120/70  | TL  | 53P |
| 481148    | 13"        | 130/60  | TL  | 53P |

↳ Grip assuré grâce à la technologie MICHELIN 2CT

↳ Plus de longévité grâce à la bande slick centrale sur les pneus avant et arrière

↳ Plus de sportivité tout au long de la vie du pneu grâce à sa sculpture dérivée des pneus moto Haute Performance



### CITY GRIP

| Référence | Dimensions | Montage | ICV |     |
|-----------|------------|---------|-----|-----|
| 496352    | 10"        | 90/90   | TL  | 50J |
| 491710    | 10"        | 100/80  | TL  | 53J |
| 481917    | 10"        | 120/70  | TL  | 54L |
| 481920    | 11"        | 110/70  | TL  | 45L |
| 493104    | 11"        | 120/70  | TL  | 56L |
| 496353    | 12"        | 90/90   | TL  | 54P |
| 496354    | 12"        | 100/90  | TL  | 64P |
| 476690    | 12"        | 110/90  | TL  | 64P |
| 476691    | 12"        | 120/70  | TL  | 51P |
| 476692    | 12"        | 120/70  | TL  | 51S |
| 476694    | 12"        | 130/70  | TL  | 62P |
| 476693    | 12"        | 130/70  | TL  | 56P |
| 491689    | 13"        | 110/70  | TL  | 48S |
| 476695    | 13"        | 110/90  | TL  | 56P |
| 476696    | 13"        | 130/70  | TL  | 63P |
| 476697    | 13"        | 140/60  | TL  | 63P |
| 484088    | 13"        | 150/70  | TL  | 64S |
| 484087    | 14"        | 90/90   | TL  | 46P |
| 484086    | 14"        | 100/90  | TL  | 57P |
| 484085    | 14"        | 110/80  | TL  | 59S |
| 476698    | 14"        | 120/70  | TL  | 55P |
| 476699    | 14"        | 120/70  | TL  | 55S |

↳ Idéal pour éviter les glissements sur sol mouillé et autres plaques d'égoûts grâce à sa technologie lamelles

↳ Equipe les modèles de scooters les plus prestigieux



| Référence | Dimensions | Montage | ICV |     |
|-----------|------------|---------|-----|-----|
| 481150    | 13"        | 130/70  | TL  | 63P |
| 481152    | 13"        | 140/60  | TL  | 57P |
| 465623    | 13"        | 150/70  | TL  | 64S |
| 481147    | 14"        | 120/80  | TL  | 58S |
| 481146    | 15"        | 120/70  | TL  | 56S |
| 481153    | 15"        | 130/80  | TL  | 63P |



| Référence | Dimensions | Montage | ICV |     |
|-----------|------------|---------|-----|-----|
| 476700    | 14"        | 140/60  | TL  | 64P |
| 476701    | 14"        | 140/60  | TL  | 64S |
| 476702    | 14"        | 140/70  | TL  | 68S |
| 476703    | 14"        | 150/70  | TL  | 66P |
| 476704    | 14"        | 150/70  | TL  | 66S |
| 476705    | 15"        | 120/70  | TL  | 56P |
| 476706    | 15"        | 120/70  | TL  | 56S |
| 483705    | 15"        | 140/70  | TL  | 69P |
| 484082    | 16"        | 90/80   | TL  | 51S |
| 476707    | 16"        | 100/80  | TL  | 50P |
| 476708    | 16"        | 110/70  | TL  | 52P |
| 476709    | 16"        | 110/70  | TL  | 52S |
| 476710    | 16"        | 110/80  | TL  | 55S |
| 483704    | 16"        | 120/70  | TL  | 57P |
| 476711    | 16"        | 120/80  | TL  | 60P |
| 493210    | 16"        | 120/80  | TL  | 60S |
| 476712    | 16"        | 130/70  | TL  | 61P |
| 476713    | 16"        | 140/70  | TL  | 65P |
| 476714    | 16"        | 140/70  | TL  | 65S |



**CITY GRIP GT**

| Référence     |     | Dimensions | Montage | ICV |
|---------------|-----|------------|---------|-----|
| <b>484084</b> | 12" | 120/70     | TL      | 51P |



**CITY GRIP WINTER**

| Référence     |     | Dimensions | Montage | ICV |
|---------------|-----|------------|---------|-----|
| <b>485321</b> | 10" | 3.50       | TL/TT   | 59J |
| <b>485323</b> | 12" | 120/70     | TL      | 58S |
| <b>485325</b> | 12" | 130/70     | TL      | 62P |
| <b>493206</b> | 13" | 130/60     | TL      | 60P |
| <b>493207</b> | 14" | 110/80     | TL      | 59S |
| <b>485326</b> | 14" | 140/60     | TL      | 64S |
| <b>485327</b> | 14" | 140/70     | TL      | 68S |
| <b>493044</b> | 15" | 120/70     | TL      | 62S |
| <b>493208</b> | 16" | 90/80      | TL      | 51S |
| <b>493209</b> | 16" | 100/80     | TL      | 56S |

- ↳ Adhérence assurée sur neige fraîche, fondante, sol mouillé et sec
- ↳ Il garantit maniabilité et stabilité pour un confort appréciable en conditions de conduite difficiles
- ↳ Son mélange de gommes garantit une mise en régime rapide à basses températures



**ACS**

| Référence     |    | Dimensions | Montage | ICV |
|---------------|----|------------|---------|-----|
| <b>320363</b> | 9" | 2.75       | TT      | 35J |

- ↳ Le spécial "9 pouces" au look rétro pour les scooters citadins



**SI**

| Référence     |     | Dimensions | Montage | ICV |
|---------------|-----|------------|---------|-----|
| <b>3637</b>   | 10" | 90/90      | TL/TT   | 50J |
| <b>3639</b>   | 10" | 100/80     | TL/TT   | 53J |
| <b>363194</b> | 10" | 100/90     | TL/TT   | 56J |
| <b>122484</b> | 10" | 110/80     | TL/TT   | 58J |
| <b>210937</b> | 10" | 130/70     | TL/TT   | 62J |
| <b>493211</b> | 10" | 3.00       | TL/TT   | 50J |

- ↳ Le pneu pour les scooters urbains: un look soigné sans compromis sur les performances
- ↳ Un design actuel et des performances sportives
- ↳ Il garantit un grip exceptionnel, une bonne maniabilité et une longévité accrue





## S83

| Référence     | Dimensions | Montage | ICV   |     |
|---------------|------------|---------|-------|-----|
| <b>320344</b> | 8"         | 3.50    | TT    | 46J |
| <b>465633</b> | 10"        | 3.00    | TL/TT | 42J |
| <b>3634</b>   | 10"        | 3.50    | TL/TT | 59J |

- ↳ Le pneu mythique du Vespa PX
- ↳ Un design rétro associé à des performances modernes
- ↳ Une sécurité maximale grâce à la haute performance de son grip



## REGGAE

| Référence   | Dimensions | Montage | ICV |     |
|-------------|------------|---------|-----|-----|
| <b>3642</b> | 10"        | 120/90  | TL  | 57J |
| <b>3643</b> | 10"        | 130/90  | TL  | 61J |

- ↳ Une sculpture polyvalente pour braver les passages les plus difficiles
- ↳ Un style original pour donner une touche particulière à votre scooter
- ↳ Une qualité irréprochable pour vous garantir qualité et sécurité



## BOPPER

| Référence     | Dimensions | Montage | ICV   |     |
|---------------|------------|---------|-------|-----|
| <b>227541</b> | 10"        | 120/90  | TL/TT | 57L |
| <b>227556</b> | 10"        | 130/90  | TL/TT | 61L |
| <b>169435</b> | 12"        | 120/70  | TL/TT | 51L |
| <b>169440</b> | 12"        | 130/70  | TL/TT | 56L |

- ↳ Une sculpture semi-slick permettant mise sur l'angle et adhérence maximale
- ↳ Un excellent feeling pour une maîtrise de tous les instants
- ↳ Une sculpture caractéristique pour un look sportif



## PILOT POWER 3 RADIAL

| Référence     | Dimensions | Montage | ICV |     |
|---------------|------------|---------|-----|-----|
| <b>493203</b> | 14"        | 120/70  | TL  | 55H |
| <b>493045</b> | 15"        | 120/70  | TL  | 56H |
| <b>493046</b> | 15"        | 160/60  | TL  | 67H |

- ↳ La technologie Styrene Butadien Rubber assure un maximum de grip sur surface humide
- ↳ Profils et gommages optimisés pour les sportives et les roadsters
- ↳ Grip, maniabilité et excellent freinage sur sol mouillé



**PILOT ROAD 4 RADIAL**

| Référence     | Dimensions | Montage | ICV    |
|---------------|------------|---------|--------|
| <b>493047</b> | 15"        | 120/70  | TL 56H |
| <b>493048</b> | 15"        | 160/60  | TL 67H |
| <b>493204</b> | 14"        | 160/60  | TL 65H |

- ↳ La technologie lamelles XST+ permet un temps de freinage optimal sur routes mouillées et surfaces très glissantes
- ↳ Une sculpture permettant un grip optimum et l'augmentation de la capacité à évacuer l'eau
- ↳ Grâce aux lamelles XST+, il bénéficie de chenfreins qui limitent l'usure irrégulière



**TWIST RACE**

| Référence     | Dimensions | Montage | ICV    |
|---------------|------------|---------|--------|
| <b>478967</b> | 12"        | 130/70  | TL 56P |

- ↳ Composition de gomme sportive avec une excellente adhérence, adaptée à la compétition
- ↳ Carcasse spécifique développée pour les conditions de compétition exigeantes
- ↳ Surface de roulement avec slicks, pour une usure moindre et une adhérence maximale



**TWIST**

| Référence     | Dimensions | Montage | ICV    |
|---------------|------------|---------|--------|
| <b>478946</b> | 10"        | 100/80  | TL 58M |
| <b>478947</b> | 10"        | 100/90  | TL 56M |
| <b>478948</b> | 10"        | 110/80  | TL 63L |
| <b>478949</b> | 10"        | 120/70  | TL 54L |
| <b>478950</b> | 10"        | 120/90  | TL 57J |
| <b>486803</b> | 10"        | 130/70  | TL 59M |
| <b>478951</b> | 10"        | 130/90  | TL 61J |
| <b>495900</b> | 10"        | 3.00    | TL 50M |
| <b>495901</b> | 10"        | 3.50    | TL 59M |
| <b>495906</b> | 10"        | 90/100  | TL 53J |
| <b>478944</b> | 10"        | 90/90   | TL 50M |
| <b>478952</b> | 11"        | 110/70  | TL 45M |
| <b>486256</b> | 12"        | 110/70  | TL 47L |
| <b>495902</b> | 12"        | 110/90  | TL 64P |

| Référence     | Dimensions | Montage | ICV    |
|---------------|------------|---------|--------|
| <b>478953</b> | 12"        | 120/70  | TL 58P |
| <b>478954</b> | 12"        | 130/70  | TL 62P |
| <b>495904</b> | 12"        | 140/70  | TL 65P |
| <b>478955</b> | 13"        | 110/90  | TL 56Q |
| <b>478956</b> | 13"        | 130/60  | TL 53P |
| <b>495905</b> | 13"        | 130/70  | TL 63Q |
| <b>478957</b> | 13"        | 140/60  | TL 63S |
| <b>478958</b> | 14"        | 120/70  | TL 55S |
| <b>478959</b> | 14"        | 140/60  | TL 64S |
| <b>478960</b> | 14"        | 140/70  | TL 68S |
| <b>478961</b> | 14"        | 150/70  | TL 66S |
| <b>478963</b> | 15"        | 120/70  | TL 56S |
| <b>478964</b> | 16"        | 110/70  | TL 52S |
| <b>478965</b> | 16"        | 140/70  | TL 65S |

- ↳ Pneu polyvalent moderne pour la ville et les routes de campagne
- ↳ Composition de gommages assurant une bonne adhérence sur route sèche et humide
- ↳ Maniabilité excellente et précision exceptionnelle



**Continental**

## TWIST FLANC BLANC

| Référence     | Dimensions | Montage | ICV    |
|---------------|------------|---------|--------|
| <b>491152</b> | 12"        | 120/70  | TL 58P |
| <b>495903</b> | 12"        | 130/70  | TL 62P |

- ↳ Pneu polyvalent moderne pour la ville et les routes de campagne
- ↳ Composition de gommages assurant une bonne adhérence sur route sèche et humide
- ↳ Maniabilité excellente et précision exceptionnelle



**Continental**

## CLASSIC

| Référence     | Dimensions | Montage | ICV    |
|---------------|------------|---------|--------|
| <b>493050</b> | 10"        | 3.50    | TT 59L |
| <b>495899</b> | 10"        | 3.00    | TT 59L |

- ↳ Le pneu traditionnel au look rétro
- ↳ La combinaison de profils segmentaires et en blocs lui donne un look traditionnel
- ↳ Composition de gommages moderne pour scooters anciens

**Deli Tire**

## URBAN GRIP SC109

| Référence     | Dimensions | Montage | ICV    |
|---------------|------------|---------|--------|
| <b>491200</b> | 12"        | 110/90  | TL 64P |
| <b>491186</b> | 12"        | 120/70  | TL 58S |
| <b>491187</b> | 12"        | 130/70  | TL 62P |
| <b>491193</b> | 13"        | 110/90  | TL 58P |
| <b>491194</b> | 13"        | 130/70  | TL 63P |
| <b>491190</b> | 13"        | 140/60  | TL 63P |
| <b>491197</b> | 13"        | 150/70  | TL 64S |
| <b>496351</b> | 14"        | 80/90   | TL 46P |
| <b>491199</b> | 14"        | 90/80   | TL 49P |
| <b>496452</b> | 14"        | 90/90   | TL 52P |
| <b>496454</b> | 14"        | 100/90  | TL 57P |
| <b>496455</b> | 14"        | 110/80  | TL 59S |
| <b>491189</b> | 14"        | 120/70  | TL 55S |
| <b>491191</b> | 14"        | 140/60  | TL 64S |
| <b>491188</b> | 14"        | 140/70  | TL 68S |
| <b>491192</b> | 15"        | 120/70  | TL 56S |
| <b>496453</b> | 16"        | 90/80   | TL 51S |
| <b>491195</b> | 16"        | 100/80  | TL 50P |
| <b>491198</b> | 16"        | 110/70  | TL 52P |
| <b>491196</b> | 16"        | 120/80  | TL 60P |





S-223

S-224

SC-101

SC-106

S-239



| Référence | Dimensions | Montage | ICV   |     |        |         |
|-----------|------------|---------|-------|-----|--------|---------|
| 460437    | 8"         | 4.00    | TT    | 62M | S-223  | CITY    |
| 460425    | 10"        | 3.00    | TL    | 42J | S-239  | CITY    |
| 460424    | 10"        | 3.50    | TL    | 51J | S-236  | CITY    |
| 460426    | 10"        | 90/90   | TL/TT | 50J | S-224  | SPORT   |
| 460423    | 10"        | 100/80  | TL    | 53J | S-223  | STREET  |
| 493603    | 10"        | 100/80  | TL    | 53L | SC-103 |         |
| 460427    | 10"        | 100/90  | TL    | 56J | S-224  | SPORT   |
| 460428    | 10"        | 120/70  | TL    | 54L | S-224  | SPORT   |
| 476727    | 10"        | 120/70  | TL    | 54L | SC-103 |         |
| 460429    | 10"        | 120/90  | TL    | 66J | S-224  | SPORT   |
| 460431    | 10"        | 120/90  | TL    | 66J | SC-101 |         |
| 481416    | 10"        | 120/90  | TL    | 66J | SC-106 |         |
| 460430    | 10"        | 130/90  | TL    | 70J | S-224  | SPORT   |
| 460432    | 10"        | 130/90  | TL    | 70J | SC-101 |         |
| 481417    | 10"        | 130/90  | TL    | 70J | SC-106 |         |
| 464834    | 10"        | 150/80  | TL    | 65L | SC-101 |         |
| 476726    | 11"        | 110/70  | TL    | 51L | SC-103 |         |
| 480577    | 12"        | 90/90   | TL    | 54J | S-220  | STREET  |
| 480575    | 12"        | 110/70  | TL    | 47L | SC-102 | X-BLADE |
| 460433    | 12"        | 120/70  | TL    | 58S | SC-102 | CORSA   |
| 481414    | 12"        | 120/70  | TL    | 51L | SC-106 |         |
| 460434    | 12"        | 130/70  | TL    | 62P | SC-102 | CORSA   |
| 481415    | 12"        | 130/70  | TL    | 56L | SC-106 |         |
| 460435    | 12"        | 140/70  | TL    | 60L | SC-102 | CORSA   |
| 460436    | 13"        | 130/60  | TL    | 60M | SC-102 | CORSA   |
| 461009    | 13"        | 140/60  | TL    | 57P | SC-102 | CORSA   |
| 464835    | 14"        | 80/80   | TL/TT | 53L | SB-108 |         |
| 481803    | 14"        | 90/90   | TL    | 46P | SC-102 | X-BLADE |
| 465684    | 14"        | 100/70  | TL/TT | 53L | SB-108 |         |
| 481804    | 14"        | 100/90  | TL    | 57P | SC-102 | X-BLADE |
| 465685    | 14"        | 110/80  | TL/TT | 59M | SB-108 |         |
| 464836    | 14"        | 120/70  | TL    | 55P | SB-112 |         |
| 464837    | 14"        | 140/60  | TL    | 64S | SB-112 |         |
| 465686    | 14"        | 140/70  | TL    | 68P | SB-112 |         |



S-236

SC-103



SC-102

S-220



SB-108

SB-112



**Mitas**

## MC 32 M+S (AGRÉÉ POSTE) SPÉCIAL NEIGE

| Référence | Dimensions | Montage | ICV       |
|-----------|------------|---------|-----------|
| 482856    | 10"        | 130/90  | TL 61L    |
| 485025    | 12"        | 120/70  | TL 58P    |
| 485026    | 12"        | 130/70  | TL 62P    |
| 482859    | 13"        | 130/90  | TL 60P    |
| 485024    | 14"        | 110/80  | TL/TT 59P |
| 485023    | 16"        | 90/80   | TL/TT 52P |
| 485027    | 16"        | 110/70  | TL 52P    |



**Mitas**

| Référence | Dimensions | Montage |       | ICV  |           |
|-----------|------------|---------|-------|------|-----------|
| 495628    | 8"         | 3.50    | TT    | B13  | 46J CITY  |
| 451992    | 8"         | 4.00    | TT    | B13  | 71J CITY  |
| 451990    | 10"        | 3.50    | TL    | MC18 | 51J CITY  |
| 451985    | 10"        | 90/90   | TL/TT | MC13 | 50J ROAD  |
| 451993    | 10"        | 100/80  | TL/TT | MC22 | 53L ROAD  |
| 451999    | 10"        | 100/90  | TL/TT | MC6  | 61J ROAD  |
| 452004    | 10"        | 110/80  | TL/TT | MC6  | 61J ROAD  |
| 458430    | 10"        | 120/70  | TL    | MC22 | 54L       |
| 478689    | 12"        | 110/70  | TL    | MC16 | 47L       |
| 451979    | 12"        | 120/70  | TL    | MC19 | 51L SPORT |
| 479763    | 12"        | 120/80  | TL    | MC19 | 55J ROAD  |
| 451976    | 12"        | 130/70  | TL    | MC16 | 56L SPORT |
| 479901    | 12"        | 130/80  | TL    | MC19 | 60J ROAD  |
| 451981    | 13"        | 130/60  | TL    | MC16 | 60P SPORT |
| 451986    | 13"        | 140/60  | TL    | MC16 | 57L SPORT |
| 454971    | 14"        | 80/80   | TL/TT | MC26 | 53L SPORT |
| 461497    | 14"        | 100/70  | TL/TT | MC26 | 53L ROAD  |
| 459664    | 14"        | 120/80  | TL    | MC28 | 58S SPORT |
| 477557    | 15"        | 140/70  | TL    | MC28 | 69P SPORT |



B13

MC22



MC6

MC18



MC28

MC13

MC16

MC19

MC26



**Mitas**

**B13 CITY FLANC BLANC**

| Référence | Dimensions | Montage | ICV |     |
|-----------|------------|---------|-----|-----|
| 495629    | 8"         | 3.50    | TT  | 46J |



**Mitas**

**B14 SPORT FLANC BLANC**

| Référence | Dimensions | Montage | ICV |     |
|-----------|------------|---------|-----|-----|
| 482854    | 10"        | 3.50    | TL  | 51J |



**Mitas**

**MC17 PAVÉ**

| Référence | Dimensions | Montage | ICV |     |
|-----------|------------|---------|-----|-----|
| 451982    | 10"        | 120/90  | TL  | 56J |
| 496747    | 10"        | 130/90  | TL  | 61J |
| 461373    | 10"        | 150/80  | TL  | 65L |



**Mitas**

**MAXIMA SPORT**

| Référence | Dimensions | Montage | ICV |     |
|-----------|------------|---------|-----|-----|
| 472391    | 10"        | 120/90  | TL  | 57P |
| 472392    | 10"        | 130/90  | TL  | 61P |
| 472393    | 12"        | 120/70  | TL  | 58P |
| 472394    | 12"        | 130/70  | TL  | 62P |
| 472395    | 13"        | 130/60  | TL  | 60P |
| 472396    | 13"        | 140/60  | TL  | 63P |



**HEIDENAU**

## NHS SLICK COMPETITION\*

| Référence     | Dimensions | Montage | ICV    |
|---------------|------------|---------|--------|
| <b>476768</b> | 10"        | 3.50    | TL RRS |
| <b>476498</b> | 12"        | 120/70  | TL RRS |

- ↳ Pneu conçu spécialement pour la compétition
- ↳ Excellente adhérence et maniabilité

\* Usage interdit sur la voie publique



**HEIDENAU**

## K61

| Référence     | Dimensions | Montage | ICV    |
|---------------|------------|---------|--------|
| <b>478275</b> | 12"        | 110/70  | TL 56M |

- ↳ Une sculpture spécialement conçue pour assurer une stabilité et une performance maximale
- ↳ Sa composition donne un bon compromis entre grip et durabilité
- ↳ Adapté à une conduite confortable ou sportive



**HEIDENAU**

## K58 M+S HIVER

| Référence     | Dimensions | Montage | ICV    |
|---------------|------------|---------|--------|
| <b>492706</b> | 12"        | 110/90  | TL 64M |

- ↳ Une bande de roulement composée de gomme au silice et de fibres de textiles spéciales
- ↳ Une adhérence garantie dans les climats froids et humides
- ↳ Une sculpture permettant un excellent drainage



**HEIDENAU**

## K66 M+S AGRÉÉ POSTE

| Référence     | Dimensions | Montage | ICV    |
|---------------|------------|---------|--------|
| <b>479646</b> | 12"        | 120/70  | TL 58S |
| <b>479647</b> | 12"        | 130/70  | TL 62P |
| <b>467532</b> | 14"        | 80/80   | TL 43J |
| <b>496054</b> | 14"        | 90/90   | TL 52P |
| <b>495780</b> | 14"        | 90/90   | TL 52P |
| <b>467533</b> | 14"        | 100/70  | TL 50J |
| <b>467535</b> | 14"        | 110/80  | TL 59P |
| <b>467536</b> | 16"        | 80/80   | TL 46J |
| <b>467534</b> | 16"        | 90/80   | TL 52J |
| <b>479358</b> | 16"        | 110/70  | TL 52J |

- ↳ Une bande de roulement composée de gomme au silice et de fibres de textiles spéciales
- ↳ Une adhérence garantie dans les climats froids et humides
- ↳ Une sculpture permettant un excellent drainage



 HUTCHINSON®

**PASEO**

| Référence     |     | Dimensions | Montage | ICV |
|---------------|-----|------------|---------|-----|
| <b>451647</b> | 13" | 130/60     | TL      | 60P |
| <b>332158</b> | 14" | 120/70     | TL      | 55P |



 HUTCHINSON®

**PLANET**

| Référence     |     | Dimensions | Montage | ICV |
|---------------|-----|------------|---------|-----|
| <b>460844</b> | 10" | 90/90      | TL      | 41J |
| <b>460845</b> | 10" | 110/80     | TL      | 58J |



 HUTCHINSON®

**FUNZY**

| Référence     |     | Dimensions | Montage | ICV |
|---------------|-----|------------|---------|-----|
| <b>173984</b> | 12" | 130/70     | TL      | 62L |



 HUTCHINSON®

**STARDUST**

| Référence     |     | Dimensions | Montage | ICV |
|---------------|-----|------------|---------|-----|
| <b>460835</b> | 10" | 120/90     | TL      | 57L |
| <b>460836</b> | 10" | 130/90     | TL      | 61L |
| <b>460837</b> | 12" | 120/70     | TL      | 58L |
| <b>460838</b> | 12" | 130/70     | TL      | 62L |
| <b>460840</b> | 13" | 130/60     | TL      | 60P |
| <b>460841</b> | 13" | 140/60     | TL      | 63P |



 HUTCHINSON®

**KWARTER**

| Référence     |     | Dimensions | Montage | ICV |
|---------------|-----|------------|---------|-----|
| <b>451651</b> | 10" | 120/90     | TL      | 56J |
| <b>451652</b> | 10" | 130/90     | TL      | 61J |
| <b>460843</b> | 10" | 150/80     | TL      | 65L |



 HUTCHINSON®

**METEOR**

| Référence     |     | Dimensions | Montage | ICV |
|---------------|-----|------------|---------|-----|
| <b>460847</b> | 14" | 100/70     | TL      | 53L |





**INFO +**

ZR signifie pneu radial.

**MODÈLES DE PNEU ROUTE PAR TAILLE**

| <b>14"</b> | 90/90  | CITY PRO<br><b>496355</b>          |  |  |  |
|------------|--------|------------------------------------|--|--|--|
|            | 90/90  | PILOT STREET<br><b>493731</b>      |  |  |  |
|            | 90/100 |                                    |  |  |  |
|            | 110/80 | M45<br><b>452065</b>               |  |  |  |
| <b>16"</b> | 80/80  | M45<br><b>452064</b>               |  | SB 108<br><b>465469</b>  |  |
|            | 90/80  | M45<br><b>454912</b>               |  |  | MC26<br><b>389599</b>  |
|            | 90/90  |                                    |  | SB 106<br><b>461006</b>  |  |
|            | 120/80 |                                    |  | SB 102 (CORSA)<br><b>461639</b>                                |  |
|            | 120/90 |                                    |  |  | MC7<br><b>211952</b>   |
|            | 130/80 |                                    |  | SB 106 R<br><b>461008</b>                                      |  |
| <b>17"</b> | 2 1/4  | M45<br><b>3646</b>                 |  |  |  |
|            | 2 3/4  | M45<br><b>3648</b>                 |  |  |  |
|            | 90/80  | PILOT STREET<br><b>465635</b>      |  | SB 101<br><b>460440</b>  | MC18<br><b>389713</b>  |
|            | 100/80 | PILOT STREET<br><b>451925</b>      | TWIST SM<br><b>478968</b>  | SB 106<br><b>460438</b><br>SB 128 SAMURAI<br><b>483484</b>     | MC25<br><b>441569</b><br>MC32<br><b>493797</b><br>MC 50 M-RACER<br><b>481600</b> |
|            | 110/70 |                                    | ZR CONTIMOTION<br><b>487066</b>                                    |  | ZR SPORTFORCE<br><b>494137</b>   |
|            | 110/80 | PILOT STREET<br><b>465637</b>      |  | SB 106<br><b>460439</b>  | MC18<br><b>212079</b>  |
|            | 120/60 |                                    | ZR CONTIMOTION<br><b>487067</b>                                    |  | ZR SPORTFORCE<br><b>494138</b>   |
|            | 120/70 |                                    | ZR CONTIMOTION<br><b>487068</b><br>ZR ROADATTACK2<br><b>478973</b> |  |  |
|            | 130/70 | PILOT STREET<br><b>451930</b>      | TWIST SM<br><b>478969</b>  | SB 106 R<br><b>460441</b><br>SB 128 R SAMURAI<br><b>483483</b> | MC25<br><b>440844</b><br>MC32<br><b>493798</b><br>MC50 M-RACER<br><b>481601</b>  |
|            | 130/80 |                                    | CONTIGO<br><b>486805</b>   |  |  |
| 150/70     |        | ZR 17 CONTIMOTION<br><b>487069</b> |  |  |  |



MODÈLES DE PNEU ROUTE PAR TAILLE

| 17" | 160/60 |                               | ZR 17 CONTIMOTION<br><b>487070</b>                                       |                      | ZR 17 SPORTFORCE+<br><b>494142</b> |
|-----|--------|-------------------------------|--|----------------------|------------------------------------|
|     | 180/55 |                               | ZR 17 CONTIMOTION<br><b>487072</b>                                       |                      | ZR 17 SPORTFORCE+<br><b>494141</b> |
|     | 190/50 |                               | ZR 17 CONTIMOTION<br><b>487073</b><br>ZR 17 SPORTATTACK<br><b>482262</b> |                      | ZR 17 SPORTFORCE+<br><b>494143</b> |
| 18" | 2.75   |                               | CONTIGO<br><b>486976</b>   |                      |                                    |
|     | 3.00   | M45<br><b>3656</b>            |  | MC7<br><b>451997</b> |                                    |
|     | 3.25   |                               |  | MC7<br><b>441573</b> |                                    |
|     | 3.50   |                               |  | MC7<br><b>441574</b> |                                    |
|     | 90/90  | PILOT STREET<br><b>466052</b> | CONTIGO<br><b>486977</b>   |                      |                                    |
|     | 100/90 |                               | CONTIGO<br><b>486804</b>   |                      |                                    |
|     | 110/90 |                               | CONTIGO<br><b>480229</b>   |                      |                                    |
| 19" | 100/90 |                               |  |                      | K65<br><b>478274</b>               |

MODÈLES DE PNEU TRAIL, CROSS ET ENDURO PAR TAILLE

| 10" | 2.50   |                        | SB 114<br><b>483845</b>   |                         |  |
|-----|--------|------------------------|---------------------------|-------------------------|--|
|     | 2.75   |                        | SB 114<br><b>479097</b>   |                         |  |
| 12" | 80/100 |                        | SB 114 R<br><b>468387</b> |                         |  |
| 14" | 60/100 |                        | SB 114 R<br><b>468386</b> |                         |  |
| 17" | 70/100 |                        | SB 114<br><b>483845</b>   |                         |  |
|     | 100/80 |                        | SB 114<br><b>479097</b>   |                         |  |
|     | 110/70 |                        | SB 114 R<br><b>468387</b> |                         |  |
|     | 120/60 |                        | SB 114 R<br><b>468386</b> |                         |  |
|     | 120/90 | SIRAC<br><b>363232</b> |                           | SB 111<br><b>484310</b> |  |
|     | 130/70 |                        |                           |                         |  |



## MODÈLES DE PNEU TRAIL, CROSS ET ENDURO PAR TAILLE

|     |        |  |  |  |  |  |
|-----|--------|---|---|---|---|---|
| 17" | 130/80 | SIRAC<br><b>363247</b>  |   |   | MC32<br><b>493797</b>   |   |
|     | 3,5    |   |   |   |   | K37<br><b>496693</b>  |
| 18" | 4.10   |   | CONTIESCAPE<br><b>490433</b>  |   |   |   |
|     | 100/80 |   |   | SB 117<br><b>479677</b>   |   |   |
|     | 110/80 | SIRAC<br><b>363251</b>  | TKC80 TWINDURO<br><b>483112</b>   | SB 107<br><b>461004</b>   | MC23<br><b>212212</b>   |   |
|     | 120/80 | SIRAC<br><b>363266</b>  |   | SB 107<br><b>476725</b><br>SB121 ENDURO<br>COMPETITION (FIM)<br><b>480589</b>     |   |   |
|     | 140/80 |   |   | SB 121 ENDURO<br>COMPETITION (FIM)<br><b>478581</b>                               |   |   |
| 19" | 100/90 |   |   | SB 114<br><b>479095</b>   |   |   |
|     | 110/90 |   |   | SB 114<br><b>479096</b>   |   |   |
| 21" | 2.75   |   | CONTIESCAPE<br><b>490432</b>  |   |   |   |
|     | 80/90  | SIRAC<br><b>363213</b>  | TKC80 TWINDURO<br><b>483746</b>   | SB 107<br><b>461005</b>   | MC23<br><b>441566</b>   |   |
|     | 80/100 |   |   | SB 114<br><b>478582</b>   |   |   |
|     | 90/90  | SIRAC<br><b>363228</b>  |   | SB 117<br><b>478583</b><br>SB 120 ENDURO<br>COMPETITION (FIM)<br><b>480312</b>    |   |   |

#MitasMoto #BestGrip #RideMitas



## SPORT FORCE+



Pour toute information, contactez:  
LIACOM SARL - 04 75 71 07 51, [contact@liacom.fr](mailto:contact@liacom.fr)

Mitas SPORT FORCE+ 

La choix du stunter Rok Bagoroš

„La réactivité du pneu dans des conditions extrêmes est l'un des facteurs clés de la cascade. Les pneus Mitas SPORT FORCE+ assurent une adhérence constante, ce qui me permet de faire des figures à la frontière du possible.“

[mitas-moto.com](http://mitas-moto.com)

 Mitas Moto

# Mitas



ROUTE



PILOT STREET

| Référence | Dimensions | Chambre | ICV   |     |
|-----------|------------|---------|-------|-----|
| 493731    | 14"        | 90/90   | TL/TT | 52P |
| 465635    | 17"        | 90/80   | TL/TT | 46S |
| 451925    | 17"        | 100/80  | TL/TT | 52S |
| 465637    | 17"        | 110/80  | TL/TT | 57S |
| 451930    | 17"        | 130/70  | TL/TT | 62S |
| 466052    | 18"        | 90/90   | TL/TT | 57P |

- ↳ Parfait pour un usage urbain quotidien
- ↳ Augmentation du taux d'entaillement pour un équilibre parfait entre adhérence et usure
- ↳ Une maniabilité très appréciée dans les embouteillages



M45

| Référence | Dimensions | Chambre | ICV   |     |
|-----------|------------|---------|-------|-----|
| 452065    | 14"        | 110/80  | TL/TT | 59S |
| 452064    | 16"        | 80/80   | TL/TT | 45S |
| 454912    | 16"        | 90/80   | TL/TT | 51S |
| 3646      | 17"        | 2-1/4   | TT    | 38S |
| 3648      | 17"        | 2-3/4   | TT    | 47S |
| 3656      | 18"        | 3.00    | TT    | 52S |

- ↳ Le pneu citadin pour les petites cylindrées qui roule aussi sur chemins
- ↳ Sculpture à pavés imbriqués pour limiter les vibrations
- ↳ Une découpe de type pneu pluie compétition qui favorise la tenue de route sur sol mouillé
- ↳ Une épaisseur de gomme plus importante au centre de la bande de roulement pour une usure plus régulière



CITY PRO

| Référence | Dimensions | Chambre | ICV |     |
|-----------|------------|---------|-----|-----|
| 496355    | 14"        | 90/90   | TT  | 52P |

- ↳ Grâce à la technologie MOT, la probabilité de perforer le pneu est très diminuée
- ↳ Un nouveau mélange de gommages permet d'augmenter de 10 % la durée d'utilisation
- ↳ Une capacité d'évacuation de l'eau revue à la hausse grâce à son sillon central, ses grains d'orge et un taux d'entaillement variable selon l'angle pris par la moto



CONTI TWIST SM

| Référence | Dimensions | Chambre | ICV |     |
|-----------|------------|---------|-----|-----|
| 478968    | 17"        | 100/80  | TL  | 52H |
| 478969    | 17"        | 130/70  | TL  | 62H |

- ↳ Adapté à l'usage routier mais excellent aussi sur route et circuit
- ↳ Un format de carcasse unique pour une légèreté dans la maniabilité
- ↳ Des matériaux modernes offrant une très bonne stabilité en virage et en ligne droite



ROUTE

PNEU MOTO / MOPED TYRE



CONTIGO

| Référence | Dimensions | Chambre | ICV    |
|-----------|------------|---------|--------|
| 486805    | 17"        | 130/80  | TL 65H |
| 486976    | 18"        | 2.75    | TT 48P |
| 486977    | 18"        | 90/90   | TL 51H |
| 486804    | 18"        | 100/90  | TL 56H |
| 480229    | 18"        | 110/90  | TL 61H |

- ↳ Adhérence parfaite en toutes circonstances climatiques pour une utilisation toute l'année
- ↳ Composition moderne offrant d'excellentes prestations kilométriques
- ↳ Surface de roulement novatrice permettant une usure uniforme et une bonne évacuation de l'eau
- ↳ Carcasse améliorée, pour une bonne maniabilité et davantage de stabilité



SB 101

| Référence | Dimensions | Chambre | ICV    |
|-----------|------------|---------|--------|
| 460440    | 17"        | 90/80   | TL 46P |



SB 106

| Référence | Dimensions | Chambre | ICV    |
|-----------|------------|---------|--------|
| 461006    | 16"        | 90/90   | TL 48P |
| 460438    | 17"        | 100/80  | TL 52R |
| 460439    | 17"        | 110/80  | TL 57R |



SB 106 R

| Référence | Dimensions | Chambre | ICV    |
|-----------|------------|---------|--------|
| 461008    | 16"        | 130/80  | TL 64P |
| 460441    | 17"        | 130/70  | TL 62R |



SB 108

| Référence | Dimensions | Chambre | ICV       |
|-----------|------------|---------|-----------|
| 465469    | 16"        | 80/80   | TL/TT 46M |



**ROUTE**

# PNEU MOTO / MOPED TYRE

**PNEUMATIQUE**



**Deli Tire**

## SB 128 SAMURAI

| Référence | Dimensions | Chambre | ICV    |
|-----------|------------|---------|--------|
| 483484    | 17"        | 100/80  | TL 52R |



**Deli Tire**

## SB 128 R SAMURAI

| Référence | Dimensions | Chambre | ICV    |
|-----------|------------|---------|--------|
| 483483    | 17"        | 130/70  | TL 62R |



**Deli Tire**

## SB 102 (CORSA)

| Référence | Dimensions | Chambre | ICV    |
|-----------|------------|---------|--------|
| 461639    | 16"        | 120/80  | TL 60P |



**Mitas**

## MC26

| Référence | Dimensions | Chambre | ICV       |
|-----------|------------|---------|-----------|
| 389599    | 16"        | 90/80   | TL/TT 52M |



**Mitas**

## MC25 BOGAR

| Référence | Dimensions | Chambre | ICV    |
|-----------|------------|---------|--------|
| 441569    | 17"        | 100/80  | TL 52R |
| 440844    | 17"        | 130/70  | TL 62R |



**Mitas**

## MC50 M-RACER

| Référence | Dimensions | Chambre | ICV    |
|-----------|------------|---------|--------|
| 481600    | 17"        | 100/80  | TL 52H |
| 481601    | 17"        | 130/70  | TL 62H |



ROUTE



MC18

| Référence | Dimensions | Chambre | ICV    |
|-----------|------------|---------|--------|
| 389713    | 17"        | 90/80   | TL 46P |
| 212079    | 17"        | 110/80  | TL 57P |



MC7

| Référence | Dimensions | Chambre | ICV    |
|-----------|------------|---------|--------|
| 211952    | 16"        | 120/90  | TL 63P |
| 451997    | 18"        | 3.00    | TT 52R |
| 441573    | 18"        | 3.25    | TL 52P |
| 441574    | 18"        | 3.50    | TL 56P |



ZR 17 SPORTFORCE+

| Référence | Dimensions | Chambre | ICV    |
|-----------|------------|---------|--------|
| 494137    | 17"        | 110/70  | TL 54W |
| 494138    | 17"        | 120/60  | TL 55W |
| 494139    | 17"        | 120/70  | TL 58W |
| 494140    | 17"        | 150/60  | TL 66W |
| 494142    | 17"        | 160/60  | TL 69W |
| 494141    | 17"        | 180/55  | TL 73W |
| 494143    | 17"        | 190/50  | TL 73W |



CONTIMOTION (SPORT/TOURING)

| Référence | Dimensions | Chambre | ICV    |
|-----------|------------|---------|--------|
| 487066    | 17"        | 110/70  | TL 54W |
| 487067    | 17"        | 120/60  | TL 55W |
| 487068    | 17"        | 120/70  | TL 58W |
| 487069    | 17"        | 150/70  | TL 69W |
| 487070    | 17"        | 160/60  | TL 69W |
| 487072    | 17"        | 180/55  | TL 73W |
| 487073    | 17"        | 190/50  | TL 73W |



- ↳ Réactivité sûre et fiable sur sol sec et humide
- ↳ Excellent rapport prix/kilomètre grâce aux nouveaux polymères employés pour la composition
- ↳ Enveloppe à ceinture métallique 0° à l'avant pour une stabilité excellente et un confort de conduite élevé





**TRAIL / CROSS / ENDURO**



**SIRAC**

| Référence     | Dimensions | Chambre | ICV    |
|---------------|------------|---------|--------|
| <b>363232</b> | 17"        | 120/90  | TT 64T |
| <b>363247</b> | 17"        | 130/80  | TT 65T |
| <b>363251</b> | 18"        | 110/80  | TT 58R |
| <b>363266</b> | 18"        | 120/80  | TT 62T |
| <b>363213</b> | 21"        | 80/90   | TT 48R |
| <b>363228</b> | 21"        | 90/90   | TT 54T |



- ↳ Assure votre sécurité aussi bien sur les routes que sur les chemins
- ↳ Une structure en nappes croisées et un mélange de gommes offrant un bon compromis entre adhérence (sec et mouillé) et longévité



**TKC80 TWINDURO**

| Référence     | Dimensions | Chambre | ICV    |
|---------------|------------|---------|--------|
| <b>483112</b> | 18"        | 110/80  | TT 58Q |
| <b>483746</b> | 21"        | 80/90   | TT 48Q |



- ↳ Pneu rigoureusement testé et éprouvé pour les longues distances et la compétition
- ↳ Profil de surface de roulement autonettoyant
- ↳ Excellente stabilité sur sol meuble
- ↳ Bonne maniabilité sur route et excellentes prestations kilométriques



**CONTIESCAPE**

| Référence     | Dimensions | Chambre | ICV    |
|---------------|------------|---------|--------|
| <b>490433</b> | 18"        | 4.10    | TT 60S |
| <b>490432</b> | 21"        | 2.75    | TT 45S |



- ↳ Composition caoutchoutée multiusage pour conditions atmosphériques et revêtements variés
- ↳ Bonne traction même en tout-terrain grâce au profil de surface de roulement
- ↳ Prestation kilométrique élevée pour les longs parcours



**Deli Tire**

**SB 107**

| Référence | Dimensions | Chambre | ICV    |
|-----------|------------|---------|--------|
| 461004    | 18"        | 110/80  | TT 58P |
| 461005    | 21"        | 80/90   | TT 48P |



**Deli Tire**

**SB 117**

| Référence | Dimensions | Chambre | ICV    |
|-----------|------------|---------|--------|
| 479677    | 18"        | 100/80  | TT 53P |
| 476725    | 18"        | 120/80  | TL 62R |
| 478583    | 21"        | 90/90   | TL 54R |



**Mitas**

**MC23**

| Référence | Dimensions | Chambre | ICV    |
|-----------|------------|---------|--------|
| 212212    | 18"        | 110/80  | TT 58P |
| 441566    | 21"        | 80/90   | TT 48P |



**Mitas**

**MC32**

| Référence | Dimensions | Chambre | ICV    |
|-----------|------------|---------|--------|
| 493797    | 17"        | 100/80  | TL 52R |
| 493798    | 17"        | 130/70  | TL 62R |



**HEIDENAU**

**K65**

| Référence | Dimensions | Chambre | ICV    |
|-----------|------------|---------|--------|
| 478274    | 19"        | 100/90  | TL 57H |





# PNEU MOTO / MOPED TYRE

**HEIDENAU**



## K37

| Référence | Dimensions | Chambre | ICV    |
|-----------|------------|---------|--------|
| 496693    | 18"        | 3.5     | TL 62P |

**Deli Tire**



## SB 111

| Référence | Dimensions | Chambre | ICV    |
|-----------|------------|---------|--------|
| 484310    | 14"        | 90/100  | TT 49M |

**Deli Tire**



## SB 114

| Référence | Dimensions | Chambre | ICV    |
|-----------|------------|---------|--------|
| 483845    | 10"        | 2.50    | TT 33J |
| 479097    | 10"        | 2.75    | TT 37J |
| 484309    | 17"        | 70/100  | TT 40M |
| 479095    | 19"        | 100/90  | TT 57M |
| 479096    | 19"        | 110/90  | TT 57M |
| 478582    | 21"        | 80/100  | TT 57M |

**Deli Tire**



## SB 114 R

| Référence | Dimensions | Chambre | ICV    |
|-----------|------------|---------|--------|
| 468387    | 12"        | 80/100  | TT 50M |
| 468386    | 14"        | 60/100  | TT 30M |

## ENDURO

**Deli Tire**



## SB 120 COMPETITION (HOMOLOGUÉ FIM)

| Référence | Dimensions | Chambre | ICV    |
|-----------|------------|---------|--------|
| 480312    | 21"        | 90/90   | TL 54R |

**Deli Tire**



## SB 121 COMPETITION (HOMOLOGUÉ FIM)

| Référence | Dimensions | Chambre | ICV    |
|-----------|------------|---------|--------|
| 480589    | 18"        | 120/80  | TT 62P |
| 478581    | 18"        | 140/80  | TT 70R |



**M45**

| Référence   | Dimensions | Montage | ICV    |
|-------------|------------|---------|--------|
| <b>3646</b> | 17"        | 2-1/4   | TT 38S |
| <b>3648</b> | 17"        | 2-3/4   | TT 47S |

↳ Le pneu citadin pour les petites cylindrées qui roule aussi sur chemins

↳ Sa sculpture à pavés imbriqués limite les vibrations et sa découpe favorise la tenue de route sur sol mouillé

↳ L'épaisseur de sa gomme est plus importante au centre que sur les côtés de la bande de roulement pour une usure plus régulière



**KKS 10 FLANC BLANC**

| Référence     | Dimensions | Montage | ICV    |
|---------------|------------|---------|--------|
| <b>480984</b> | 19"        | 2       | TT 24B |



**SB108**

| Référence     | Dimensions | Montage | ICV    |
|---------------|------------|---------|--------|
| <b>465467</b> | 16"        | 2-1/4   | TT 38J |
| <b>460442</b> | 16"        | 2-1/2   | TL 42J |



**S240**

| Référence     | Dimensions | Montage | ICV    |
|---------------|------------|---------|--------|
| <b>460443</b> | 16"        | 2-3/4   | TT 36J |



**S215**

| Référence     | Dimensions | Montage | ICV       |
|---------------|------------|---------|-----------|
| <b>460444</b> | 17"        | 2-1/4   | TT 28J    |
| <b>460445</b> | 17"        | 2-3/4   | TL/TT 38J |



**B4 FLANC BLANC**

| Référence     | Dimensions | Montage | ICV    |
|---------------|------------|---------|--------|
| <b>482390</b> | 18"        | 2-1/4   | TT 42J |



**Mitas**

## B7 FLANC BLANC

| Référence     | Dimensions | Montage | ICV |
|---------------|------------|---------|-----|
| <b>495633</b> | 17" 2-3/4  | TL/TT   | 47J |



**Mitas**

## B8 FLANC BLANC

| Référence     | Dimensions | Montage | ICV |
|---------------|------------|---------|-----|
| <b>486409</b> | 16" 2-1/4  | TT      | 38J |



**Mitas**

## MC2

| Référence     | Dimensions | Montage | ICV |
|---------------|------------|---------|-----|
| <b>209152</b> | 16" 2-1/4  | TT      | 38J |
| <b>265992</b> | 16" 2-1/2  | TL/TT   | 42J |
| <b>266874</b> | 16" 2-3/4  | TL/TT   | 46J |



**Mitas**

## MC2 FLANC BLANC

| Référence     | Dimensions | Montage | ICV |
|---------------|------------|---------|-----|
| <b>486813</b> | 16" 2-1/2  | TL/TT   | 42J |
| <b>486424</b> | 16" 2-3/4  | TL/TT   | 46J |



**Mitas**

## MC11

| Référence     | Dimensions | Montage | ICV |
|---------------|------------|---------|-----|
| <b>490737</b> | 17" 2      | TT      | 31J |
| <b>209133</b> | 17" 2-1/4  | TT      | 39J |
| <b>389603</b> | 17" 2-1/2  | TL/TT   | 43J |
| <b>209148</b> | 17" 2-3/4  | TL/TT   | 47J |



**Mitas**

## MC11 FLANC BLANC

| Référence     | Dimensions | Montage | ICV |
|---------------|------------|---------|-----|
| <b>486410</b> | 17" 2-1/4  | TT      | 39J |



Mitas

**MC51 (M+S)**

| Référence | Dimensions | Montage | ICV    |
|-----------|------------|---------|--------|
| 495630    | 17"        | 2-1/2   | TL 43P |
| 495631    | 17"        | 2-3/4   | TL 47P |

↳ Pneu boue et neige adapté aux conditions de conduite hivernales ou pour une utilisation toute l'année.



**HUTCHINSON**

| Référence      | Dimensions | Montage | ICV    |
|----------------|------------|---------|--------|
| <b>NERVURE</b> |            |         |        |
| 122738         | 19"        | 1-3/4   | TT 21B |
| <b>SPHERUS</b> |            |         |        |
| 454921         | 16"        | 2-1/4   | TL 38B |
| 454920         | 16"        | 2-1/4   | TT 38B |
| 454922         | 16"        | 2-1/2   | TL 42B |
| 454924         | 17"        | 2-1/4   | TT 39B |
| <b>GPI</b>     |            |         |        |
| 163972         | 16"        | 2-1/2   | TL 35L |
| 3829           | 16"        | 2-3/4   | TL 45L |
| 3828           | 16"        | 2-3/4   | TT 45L |
| 3831           | 17"        | 2-1/4   | TT 38L |
| 164057         | 17"        | 2-1/2   | TT 35L |
| 3834           | 17"        | 2-3/4   | TT 35L |
| <b>VROOM</b>   |            |         |        |
| 122135         | 16"        | 2       | TT 20B |
| 163953         | 16"        | 2-1/2   | TT 42B |
| 163987         | 16"        | 2-3/4   | TL 46B |
| 164008         | 17"        | 2       | TT 31B |
| 164103         | 18"        | 2-1/4   | TT 29B |
| 164137         | 19"        | 2       | TT 24B |
| <b>TURBO</b>   |            |         |        |
| 122082         | 17"        | 2-1/4   | TT 28J |
| 164084         | 17"        | 2-3/4   | TT 47J |



NERVURE



SPHERUS



GPI



VROOM



TURBO



Valve coudée  
90°



Valve coudée  
filetée 90°



Valve coudée  
150°



Valve droite



Valve presta  
droite filetée



Valve droite  
filetée



## CHAMBRE À AIR

| Référence | Dimension | Valve                              |    | Repères             |        |
|-----------|-----------|------------------------------------|----|---------------------|--------|
| 3669      | 4"        | 4.00                               | VS | coudée filetée 90°  | 4AB    |
| 320378    | 8"        | 3.50                               | VS | coudée filetée 150° | 8B1    |
| 3664      | 8"        | 4.00                               | VS | droite              | 8B4    |
| 3665      | 8"        | 4.50                               | VS | coudée filetée 90°  | 8C3    |
| 121249    | 9"        | 2.75                               | VS | coudée filetée 90°  | 9AB3   |
| 3661      | 10"       | 3.00 110/80                        | VS | coudée filetée 90°  | 10B4   |
| 320382    | 10"       | 3.00 110/80                        | VS | coudée filetée 150° | 10B1   |
| 454918    | 10"       | 4.00-4.50                          | VS | droite              | 10CG13 |
| 3667      | 10"       | 4.00                               | VS | coudée filetée 90°  | 10C3   |
| 3668      | 10"       | 4.50 130/70 120-130/90             | VS | coudée filetée 90°  | 10D    |
| 320397    | 12"       | 3.0-3.50 DIRT                      | VS | coudée filetée 150° | 12B1   |
| 489846    | 12"       | 2.50 80/100                        | VS | droite filetée TR4  | 12MCR  |
| 454915    | 15"       | 4.50-5.50 180/70 170/80 150/90     | VS | coudée filetée 90°  | 15MJ   |
| 363285    | 15"       | 4.50 130/90                        | VS | coudée filetée 90°  | 15MI   |
| 465651    | 16"       | 2.50-2.75 90/80                    | VS | droite filetée      | 16MD   |
| 465653    | 16"       | 3.25-3.50 100/90                   | VS | droite filetée      | 16MF   |
| 320488    | 16"       | 4.00-4.50 110-120/80               | VS | droite              | 16MG   |
| 465654    | 16"       | 4.25-5.50 140-150/80 120-130/90    | VS | coudée filetée 90°  | 16MI   |
| 480110    | 16"       | 4.25-5.50 120-130/90 150/80        | VS | droite filetée      | 16MI2  |
| 465650    | 17"       | 2.25-2.50                          | VS | droite filetée      | 17MC   |
| 3672      | 17"       | 2.75                               | VS | droite filetée      | 17MD   |
| 3673      | 17"       | 3.00 100/80                        | VS | droite filetée      | 17ME   |
| 465655    | 17"       | 4.00-4.50 110-120/70 110/80        | VS | droite filetée      | 17MG   |
| 320511    | 17"       | 4.50-5.10 120-140/70 130/80        | VS | droite filetée      | 17MH   |
| 3674      | 17"       | 4.50-5.50 150-160/70 140/80 130/90 | VS | droite filetée      | 17MI   |
| 3675      | 18"       | 2.50                               | VS | droite filetée      | 18MC   |
| 3676      | 18"       | 2.75-3.00 90/90                    | VS | droite filetée      | 18ME   |
| 460472    | 18"       | 3.25-3.50 110-120/80 100-110/90    | VS | droite filetée      | 18MF   |
| 497443    | 18"       | 120/90                             | VS | droite              | 18UHD  |
| 320550    | 19"       | 3.00 90/90                         | VS | droite filetée      | 19ME   |
| 3679      | 19"       | 3.25 110/80 100-110/90             | VS | droite filetée      | 19MF   |
| 197446    | 19"       | 120/80 100-110/90                  | VS | droite              | 19UHD  |
| 460473    | 21"       | 2.50-2.75-3.00 80-90/90            | VS | droite filetée      | 21MD   |
| 460691    | 21"       | 3.00-3.50 100/80 90/90             | VS | droite filetée      | 21MDR  |
| 497447    | 21"       | 90/90                              | VS | droite              | 21UHD  |



Valve coudée  
90°



Valve coudée  
filetée 90°



Valve coudée  
150°



Valve droite



Valve presta  
droite filetée



Valve droite  
filetée



CHAMBRE À AIR

| Référence | Dimension | Valve                         |                              |
|-----------|-----------|-------------------------------|------------------------------|
| 389460    | 8"        | 3.50-4.00                     | VS coudée filetée 90°        |
| 484306    | 10"       | 2.50-2.75                     | VS coudée filetée 90°        |
| 3883      | 10"       | 3.00-3.25 90/90-100/90        | VS coudée filetée 90°        |
| 3886      | 10"       | 4.00-4.50 120/90-130/90       | VS coudée filetée 90°        |
| 479841    | 12"       | 3.00-3.50 DIRT                | VS droite                    |
| 251033    | 12"       | 4.00 120/70-130/70            | VS droite                    |
| 251048    | 13"       | 130/60-140/60                 | VS coudée filetée 90°        |
| 481792    | 14"       | 2.50-2.75 DIRT                | VS droite                    |
| 481793    | 14"       | 120/70-60                     | VS droite                    |
| 3878      | 16"       | 2-1/4                         | VS droite                    |
| 482494    | 16"       | 2-1/4                         | VS droite filetée avec écrou |
| 389455    | 16"       | 2-3/4                         | VS droite                    |
| 389508    | 16"       | 3.00-3.25 90/90               | VS droite                    |
| 389512    | 16"       | 4.50-5.10 120/90              | VS droite                    |
| 3879      | 17"       | 2-1/4                         | VP droite filetée            |
| 482495    | 17"       | 2-1/4                         | VS droite filetée avec écrou |
| 3882      | 17"       | 2-1/4                         | VS droite                    |
| 3880      | 17"       | 2-3/4                         | VS droite                    |
| 482496    | 17"       | 2-3/4                         | VS droite filetée avec écrou |
| 389531    | 17"       | 3.00-3.25                     | VS droite                    |
| 389546    | 17"       | 4.25-5.10 130/90              | VS droite                    |
| 187590    | 18"       | 2-1/4                         | VS droite                    |
| 280062    | 18"       | 2.75-3.00 90/90               | VS droite                    |
| 280096    | 18"       | 3.25-3.50 100/90              | VS droite filetée            |
| 449931    | 18"       | 4.00-4.50                     | VS droite                    |
| 483744    | 19"       | 1-3/4   2                     | VS droite                    |
| 483743    | 19"       | 1-3/4   2                     | VP droite filetée            |
| 389570    | 19"       | 3.25-3.50                     | VS droite                    |
| 375505    | 21"       | 2.50-2.50                     | VS droite                    |
| 375510    | 21"       | 2.75-3.00 90/90 100/80 110/80 | VS droite                    |



# CHAMBRE A AIR / INNER TUBE



Valve coudée  
90°



Valve coudée  
filetée 90°



Valve coudée  
150°



Valve droite



Valve presta  
droite filetée



Valve droite  
filetée

## HEIDENAU

### CHAMBRE À AIR

| Référence | Dimension | Valve                |                       |
|-----------|-----------|----------------------|-----------------------|
| 494063    | 4"        | 4.00                 | VS coudée filetée 90° |
| 478273    | 14"       | 2.50-3.00 80/80 DIRT | VS droite filetée     |



## HUTCHINSON

### CHAMBRE À AIR

| Référence | Dimension | Valve         |                   |
|-----------|-----------|---------------|-------------------|
| 165774    | 16"       | 2-1/4   2-1/2 | VS droite         |
| 164433    | 16"       | 2-3/4         | VS droite         |
| 164395    | 17"       | 2-1/4   2-1/2 | VP droite filetée |
| 165573    | 17"       | 2-1/4   2-1/2 | VS droite         |
| 164387    | 17"       | 2-3/4         | VS droite filetée |
| 164361    | 18"       | 2-1/4         | VP droite filetée |
| 165588    | 18"       | 2-1/4         | VS droite         |
| 164319    | 19"       | 2             | VP droite filetée |
| 454928    | 19"       | 2             | VS droite         |
| 165588    | 18"       | 2-1/4         | VS droite         |
| 164319    | 19"       | 2             | VP droite filetée |
| 454928    | 19"       | 2             | VS droite         |



## SCHWALBE

### CHAMBRE À AIR

| Référence | Dimension | Valve |                              |
|-----------|-----------|-------|------------------------------|
| 481807    | 16"/17"   | 2-1/4 | VS droite filetée avec écrou |



# CAPUCHON DE VALVE / VALVE CAP



## CAPUCHON DE VALVE ALU X2

487265 noir déco jaune



487265



## CAPUCHON DE VALVE ALU 6 PANS X2

277218 bleu

277237 noir

277222 or

277203 rouge

277241 vert



277218



277237



277222



277203



277241



## CAPUCHON DE VALVE ALU OBUS X2

Lisse

334347 bleu

388430 chrome

334366 noir

334351 or

334377 rouge

334385 vert

Rainuré

464985 bleu

464987 rouge



334347



388430



334366



334351



334377



334385



464985



464987



## CAPUCHON DE VALVE ALU ROCKET X2

466322 bleu

466323 chrome

466324 noir

466325 rouge



466322

466323

466324

466325



## CAPUCHON DE VALVE ALU TO COOL MOLETÉ X2

|        |       |
|--------|-------|
| 464982 | bleu  |
| 464983 | noir  |
| 464984 | rouge |



464982



464983



464984



## CAPUCHON DE VALVE X2

|        |       |           |
|--------|-------|-----------|
| 478310 | COBRA | chrome    |
| 484672 | ALIEN | éclairant |
| 478309 | POING | chrome    |
| 478308 | SKULL | chrome    |



478310



484672



478309



478308



## CAPUCHON DE VALVE ALU HEXAGONAL X24

|        |                    |
|--------|--------------------|
| 186957 | couleurs assorties |
|--------|--------------------|



## CAPUCHON DE VALVE GRENADE X2

|        |        |
|--------|--------|
| 475307 | bleu   |
| 475309 | or     |
| 475308 | rouge  |
| 475310 | argent |



475307



475309



475308



475310



**CAPUCHON DE VALVE PISTON X2**

|        |       |
|--------|-------|
| 292904 | bleu  |
| 292938 | noir  |
| 292919 | or    |
| 292923 | rouge |
| 330174 | vert  |



**CAPUCHON DE VALVE DÉ X2**

|        |       |
|--------|-------|
| 493092 | noir  |
| 493093 | rouge |



**VALVE ALU X1**

|        |     |        |
|--------|-----|--------|
| 487604 | alu | or     |
| 487605 | alu | argent |
| 487601 | alu | rouge  |
| 487603 | alu | bleu   |



**VALVE ALU X2**

|        |     |        |
|--------|-----|--------|
| 377015 | alu | or     |
| 377007 | alu | violet |



**VALVE**

|                    |                 | Longueur | Quantité |
|--------------------|-----------------|----------|----------|
| 186699             | coudée          |          | x1       |
| 485486             | droite courte   | 32mm     | x1       |
| 376937             | standard droite | 43mm     | x1       |
| 493341             | droite longue   | 49mm     | x1       |
| Boîte de 50 unités |                 |          |          |
| 496098             | standard droite | 43mm     | x50      |
| 496097             | droite longue   | 49mm     | x50      |



# PIÈCES DÉTACHÉES ROUES / WHEEL PARTS



**INFO TECHNIQUE**  
2RS signifie étanche



## ROULEMENT DE ROUE

| Référence | Appellation | Ø intérieur (mm) | Ø extérieur (mm) | Largeur (mm) |                                     |
|-----------|-------------|------------------|------------------|--------------|-------------------------------------|
| 7967      | 6000-2RS    | 10               | 28               | 8            |                                     |
| 7966      | 6001-2RS    | 12               | 28               | 8            |                                     |
| 480906    | 6002-2RS    | 15               | 32               | 9            |                                     |
| 480569    | 6003-2RS    | 17               | 35               | 10           |                                     |
| 440839    | 6004-2RS    | 20               | 42               | 12           | SPEEDFIGHT   TREKKER   BUXY         |
| 491123    | 6005-2RS    | 25               | 47               | 12           |                                     |
| 7968      | 6200-2RS    | 10               | 30               | 9            |                                     |
| 7969      | 6201-2RS    | 12               | 32               | 10           |                                     |
| 379166    | 6202-2RS    | 15               | 35               | 11           | SENDA   RS50   LUDIX   SPEEDFIGHT 3 |
| 478384    | 6203-2RS    | 17               | 40               | 12           | BOOSTER   BW'S                      |
| 465069    | 6204-2RS    | 20               | 47               | 14           |                                     |
| 495738    | 6205-2RS    | 25               | 52               | 15           | direction SENDA                     |
| 479669    | 6300-2RS    | 10               | 35               | 11           |                                     |
| 482756    | 6301-2RS    | 12               | 37               | 12           |                                     |
| 482637    | 6302-2RS    | 15               | 42               | 13           |                                     |
| 495052    | 6303-2RS    | 17               | 47               | 14           |                                     |



## ROULEMENT ARBRE DE ROUE + JOINT SPI

| Référence | Appellation | Ø intérieur (mm) | Ø extérieur (mm) | Largeur (mm) |                      |
|-----------|-------------|------------------|------------------|--------------|----------------------|
| 440837    | 6203-2RS    | 17               | 40               | 12           | BOOSTER   BW'S       |
| 493927    | 6004-2RS    | 20               | 42               | 12           | SPEEDFIGHT   TREKKER |
| 440838    | 6204-2RS    | 20               | 47               | 14           | TYPHOON   NRG        |



## FOND DE JANTE

|        |         |      |
|--------|---------|------|
| 482984 | 12"     | 24mm |
| 482985 | 15"     | 46mm |
| 482986 | 16"-17" | 28mm |
| 482987 | 17"     | 42mm |
| 482988 | 18"-19" | 28mm |
| 482989 | 21"     | 28mm |





Sélection  
**CGN**

**FOND DE JANTE**

|        |     |       |      |
|--------|-----|-------|------|
| 175767 | 16" | 2     | 28mm |
| 3933   | 17" | 2     | 19mm |
| 3934   | 17" | 2-1/4 | 21mm |
| 484130 | 18" | 2-1/4 | 30mm |



Sélection  
**CGN**

**AXE DE ROUE AVANT**

|        |                |                |
|--------|----------------|----------------|
| 451086 | BOOSTER SPIRIT | longueur 240mm |
|--------|----------------|----------------|



Sélection  
**CGN**

**ECROU DE ROUE AVANT X1**

|        |                            |                     |             |
|--------|----------------------------|---------------------|-------------|
| 481459 | TREKKER   VIVACITY   LUDIX | écrou frein 12x1.25 | bague nylon |
| 481461 | TYPHOON                    | écrou frein 12x1.25 | bague nylon |
| 481458 | BOOSTER   OVETTO   ROCKET  | écrou frein 10x1.25 | bague nylon |



481459



481461



481458

**ECROU DE ROUE ARRIÈRE X1**

|        |  |                    |             |  |
|--------|--|--------------------|-------------|--|
| 482370 | BOOSTER   OVETTO   ROCKET   TKR   VIVACITY   LUDIX | écrou frein métal  |             |  |
| 481457 | BOOSTER   OVETTO   ROCKET   TKR   VIVACITY   LUDIX | écrou frein 14x1.5 |             |  |
| 481460 | SCOOTER 50 CHINOIS                                 | écrou frein 16x1.5 | bague nylon |  |



482370



481457



481460

# EQUIPEMENT

|                           |     |
|---------------------------|-----|
| Antivols _____            | 574 |
| Équipement véhicule _____ | 583 |
| Masque _____              | 581 |
| Top-case _____            | 591 |
| Vêtement/Protection _____ | 577 |

**ANTIVOL EN U**

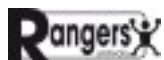

**ANTIVOL EN U**

|               |                                     |
|---------------|-------------------------------------|
| <b>487854</b> | 65x55mm                             |
| <b>487855</b> | 65x55mm avec chaîne 1.00m Ø13.5mm   |
| <b>455129</b> | 65x55mm avec chaîne 1.20m (non SRA) |
| <b>487851</b> | 85x100mm                            |
| <b>487852</b> | 85x250mm                            |
| <b>487853</b> | 110x230mm                           |

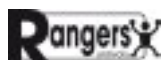

**ANTIVOL EN U**

|               |                                 |
|---------------|---------------------------------|
| <b>496373</b> | 55x55mm avec chaîne lasso 1.20m |
| <b>451596</b> | 165x320mm                       |

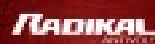
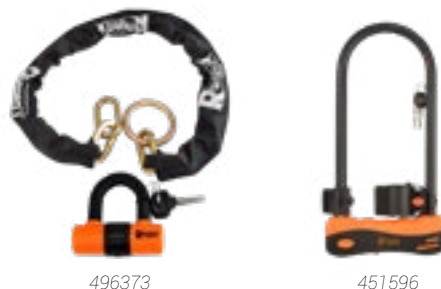

**ANTIVOL EN U FABRICATION CEE**

|               |                                 |
|---------------|---------------------------------|
| <b>480339</b> | 55x55mm avec chaîne 1.00m Ø14mm |
|---------------|---------------------------------|



**ANTIVOL EN U FABRICATION CEE**

|               |          |
|---------------|----------|
| <b>480334</b> | 85x250mm |
|---------------|----------|



**ANTIVOL EN U FABRICATION CEE**

|               |   |
|---------------|---|
| <b>486955</b> | 55x55mm                                   |
| <b>486954</b> | 55x55mm avec chaîne lasso 1.20m (non SRA) |
| <b>486268</b> | 85x125mm                                  |
| <b>486270</b> | 85x250mm                                  |
| <b>486271</b> | 85x300mm                                  |

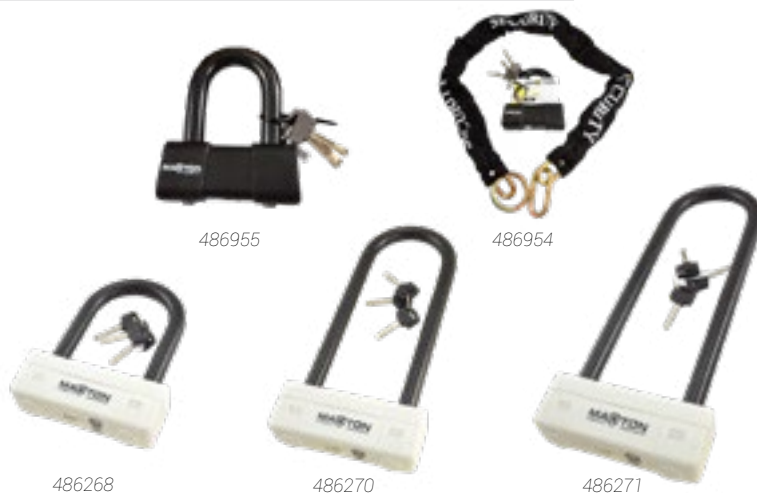



ANTIVOL BLOQUE DISQUE

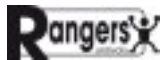

ANTIVOL EN U

484137 55x55mm

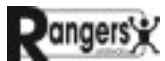

ANTIVOL BLOQUE DISQUE

485180 Ø6mm avec alarme

170693 Ø6mm

247337 Ø10mm

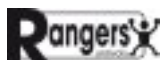

ANTIVOL BLOQUE DISQUE FABRICATION CEE

486957 Ø6mm avec alarme

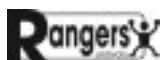

CORDON DE RAPPEL

487245 pour antivol jaune fluo



ANTIVOL BLOQUE DISQUE

494282 Ø10mm avec alarme

489722 Ø14mm inox avec alarme

489723 Ø14mm noir mat

Pile pour antivol avec alarme

497357 pile lithium 3V CR2 x1



## ANTIVOL ARTICULÉ

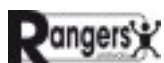

## ANTIVOL ARTICULÉ (CLÉ TUBULAIRE)

|        |             |
|--------|-------------|
| 166201 | 1.00m Ø25mm |
| 170689 | 1.50m Ø25mm |



## ANTIVOL À CHAÎNE

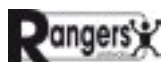

## ANTIVOL À CHAÎNE AVEC CADENAS

|        |       |
|--------|-------|
| 441925 | 1.20m |
| 449731 | 1.5m  |

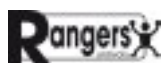

## ANTIVOL À CHAÎNE AVEC SERRURE INTÉGRÉE

|        |       |
|--------|-------|
| 451589 | 1.20m |
| 451590 | 1.50m |
| 451591 | 1.80m |

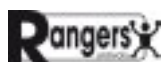

## ANTIVOL CHAÎNE SEULE

|        |                   |
|--------|-------------------|
| 491387 | 1.20m type lasso  |
| 477626 | 1.20m type normal |



## ANTIVOL CHAÎNE SEULE FABRICATION CEE

|        |                  |
|--------|------------------|
| 487311 | 1.20m type lasso |
|--------|------------------|



## ANTIVOL BLOQUE GUIDON



## ANTIVOL BLOQUE GUIDON

|        |                              |
|--------|------------------------------|
| 491611 | guidon/levier poignée de gaz |
|--------|------------------------------|



## CORRESPONDANCE DES TAILLES DES BLOUSONS

| Tour de poitrine (cm) | 80 à 84   | 84 à 88  | 88 à 92 | 92 à 96 | 96 à 100 | 100 à 104 | 104 à 108 | 108 à 112  | 112 à 116   |
|-----------------------|-----------|----------|---------|---------|----------|-----------|-----------|------------|-------------|
| Equivalence           | 42<br>XXS | 44<br>XS | 46<br>S | 48<br>M | 52<br>L  | 52<br>XL  | 54<br>XXL | 56<br>XXXL | 58<br>XXXXL |

## CORRESPONDANCE DES TAILLES DES PANTALONS

| Tour de taille (cm) | 64 à 68 | 68 à 72 | 72 à 76 | 76 à 80 | 80 à 84 | 84 à 90 | 90 à 96 | 96 à 104 | 104 à 110 |
|---------------------|---------|---------|---------|---------|---------|---------|---------|----------|-----------|
| Equivalence         | 34      | 36      | 38      | 40      | 42      | 44      | 46      | 48       | 50        |



### COMBINAISON DE PLUIE CARDIFF NOIRE

|        |     |
|--------|-----|
| 472869 | S   |
| 472868 | M   |
| 472871 | L   |
| 472872 | XL  |
| 472870 | XXL |



- ↳ Élastiques aux poignets
- ↳ Chevilles ajustables par bouton pression
- ↳ Fermeture à glissière sous rabat
- ↳ Bande rétroréfléchissante au dos
- ↳ Poche de rangement intégrée
- ↳ 100% polyester



### COMBINAISON DE PLUIE STORM NOIRE ET FLUO

|        |     |
|--------|-----|
| 491250 | S   |
| 491251 | M   |
| 491252 | L   |
| 491253 | XL  |
| 491254 | XXL |



- ↳ Élastiques aux poignets
- ↳ Chevilles ajustables par bouton pression
- ↳ Fermeture à glissière sous rabat
- ↳ Bandes rétroréfléchissantes
- ↳ Poche de rangement intégrée
- ↳ 100% polyester



### PANTALON DE PLUIE WESTON NOIR AVEC DOUBLURE

|        |     |
|--------|-----|
| 477071 | S   |
| 477072 | M   |
| 477073 | L   |
| 477074 | XL  |
| 477075 | XXL |

- ↳ 100% étanche
- ↳ Coutures soudées
- ↳ Chevilles ajustables par scratch



### PANTALON DE PLUIE WESTON NOIR

|        |     |
|--------|-----|
| 370939 | S   |
| 370943 | M   |
| 477069 | L   |
| 370962 | XL  |
| 477070 | XXL |

- ↳ 100% étanche
- ↳ Coutures soudées



### VESTE DE PLUIE SHEFFIELD NOIRE AVEC DOUBLURE

|        |     |
|--------|-----|
| 477079 | S   |
| 477080 | M   |
| 477081 | L   |
| 477082 | XL  |
| 477083 | XXL |

- ↳ Etanche
- ↳ 100% polyester
- ↳ Liseré réfléchissant
- ↳ Doublure thermique amovible
- ↳ Poche intérieur
- ↳ Ceinture taille ajustable par scratch



### VESTE DE PLUIE SHEFFIELD NOIRE

|        |    |
|--------|----|
| 477076 | S  |
| 477077 | M  |
| 288283 | L  |
| 297375 | XL |

- ↳ Etanche
- ↳ Fermeture zip avec rabas velcro goutte d'eau
- ↳ 100% polyester
- ↳ 2 poches extérieures





### ENSEMBLE 2 PIÈCES VESTE ET PANTALON DE PLUIE NOIR

|        |     |
|--------|-----|
| 483495 | S   |
| 483496 | M   |
| 483497 | L   |
| 483498 | XL  |
| 483499 | XXL |

- ↳ Élastiques aux poignets
- ↳ Entièrement doublé
- ↳ Coutures protégées par inserts
- ↳ Fermeture à glissière sous rabat avec bouton pression
- ↳ Capuche dans le col
- ↳ Bandes rétroréfléchissantes de sécurité 3M scotchlite
- ↳ Pantalon élastique à la taille et aux chevilles ajustable par bouton pression



### ENSEMBLE 2 PIÈCES VESTE ET PANTALON DE PLUIE STORM NOIR ET JAUNE FLUO

|        |     |
|--------|-----|
| 494737 | S   |
| 494738 | M   |
| 494739 | L   |
| 494740 | XL  |
| 494741 | XXL |

- ↳ Entièrement doublé
- ↳ Élastiques aux poignets
- ↳ Coutures protégées par inserts
- ↳ Fermeture à glissière sous rabat avec bouton pression
- ↳ Capuche dans le col



### GILET DE SÉCURITÉ JAUNE BANDE RÉFLÉCHISSANTE

|        |        |
|--------|--------|
| 483070 | XS-S   |
| 483071 | M-L    |
| 483072 | XL-XXL |

- ↳ Homologuée EN1150
- ↳ Jour et nuit
- ↳ Pour scooter et moto
- ↳ Avec bandes réfléchissantes





## BRASSARD DE SÉCURITÉ

- 478144 réfléchissant jaune fluo  
460068 réfléchissant lumineux jaune fluo avec led



478144



460068



## SOUS GANT NOIR (PAIRE)

- 480926 S  
480927 M  
480928 L



## SUR GANT DE PLUIE NOIR

- 491257 taille unique



## CAGOLE CHOUETTE

- 494742 100% soie  
1200 coton  
479714 polyester



494742



1200



479714



## CAGOLE HUBLLOT

- 494743 100% soie  
1201 coton  
479713 polyester



494743



1201



479713



## TOUR DE COU

- 461276 polyester  
487373 polaire  
487397 plastron polyester



461276



487373



487397



## MASQUE CROSS

- 488706 noir
- 488705 blanc
- 488709 orange fluo
- 488710 vert fluo
- 493729 jaune fluo mat
- 493730 rouge mat



488706

488705

488709



488710

493729

493730



## ÉCRAN LUNETTE ANTI-BUÉE ET ANTI-RAYURE MIROIR FUMÉ

- 490224 miroir fumé
- 491137 incolore



490224



491137



## MASQUE 3201 ÉCRAN ANTI-RAYURE ET ANTI-UV

- 486147 noir
- 486148 argent
- 486153 blanc
- 486152 bleu
- 486150 jaune
- 486151 orange
- 486154 rouge
- 486149 vert



486147

486148

486153



486152

486150

486151



486154

486149



## MASQUE 3301 ÉCRAN ANTI-BUÉE ET ANTI-RAYURE

- 294213 noir





### MASQUE 3204 FLUO ÉCRAN ANTI-RAYURE ET ANTI-UV

|        |        |
|--------|--------|
| 489882 | jaune  |
| 489884 | orange |
| 489881 | rouge  |
| 489883 | vert   |



489882



489884



489881



489883



### MASQUE ENFANT 3101 ÉCRAN ANTI-BUÉE

|        |       |
|--------|-------|
| 441926 | noir  |
| 490527 | rouge |
| 490528 | vert  |



441926



490527



490528



### ÉCRAN LUNETTE

|        |  |               |              |
|--------|--|---------------|--------------|
| 481755 | pour masques 3101   3201   3204   3301   3400   3450 | fumé          | simple écran |
| 465706 | pour masques 3101   3201   3204   3301   3400   3450 | miroir argent | simple écran |
| 460233 | pour masques 3101   3201   3204   3301   3400   3450 | miroir bleu   | simple écran |
| 374748 | pour masques 3101   3201   3204   3301   3400   3450 | transparent   | double écran |
| 171140 | pour masques 3101   3201   3204   3301   3400   3450 | transparent   | simple écran |
| 171154 | écran jetable (x10)                                  |               |              |



481755



465706



460233



374748



171140



171154



### LUNETTE TYPE AVIATEUR

|        |         |
|--------|---------|
| 497429 | bordeau |
| 497430 | marron  |
| 497427 | noir    |



497429



497430



497427



### ÉCRAN LUNETTE DARK ANTI-BUÉE ANTI-RAYURE

|        |      |
|--------|------|
| 496632 | fumé |
|--------|------|







## MANCHON

|               |               |  |
|---------------|---------------|--|
| <b>476559</b> | scooter/cyclo | néoprène noir, avec stabilisateur                              |
| <b>488103</b> | scooter/cyclo | néoprène noir, sans stabilisateur                              |
| <b>496067</b> | maxi-scooter  | noir, pour guidon avec ou sans stabilisateur                   |
| <b>496068</b> | maxi-scooter  | noir, pour guidon avec rétroviseurs avec ou sans stabilisateur |



476559



488103



496067



496068



## MANCHON SCOOTER/CYCLO

**495193** polycuir et néoprène avec thermo-doublure et stabilisateur



## MANCHON SCOOTER/CYCLO

**8194** standard



## MANCHON SCOOTER/CYCLO

**481811** universel avec termo-doublure  
**496746** standard doublure fourrure synthétique



481811



496746



## TABLIER SCOOTER UNIVERSEL

**483069** doublure rembourée



## AFFECTATION VÉHICULE DES TABLIERS

| Cylindrée      | Modèle      | Année début | Année fin | Modèle Tucano | Référence |
|----------------|-------------|-------------|-----------|---------------|-----------|
| <b>APRILIA</b> |             |             |           |               |           |
| 125cc          | LEONARDO    | 1996        |           | R017          | 292327    |
| <b>HONDA</b>   |             |             |           |               |           |
| 125CC          | PCX         | 2010        |           | R082          | 485628    |
| 125CC          | SH          | 2013        |           | R099          | 493612    |
| 125CC          | FORZA       | 2015        |           | R176C         | 492532    |
| <b>KYMCO</b>   |             |             |           |               |           |
| 50CC           | AGILITY     | 2004        |           | R017          | 292327    |
| 50CC           | BET&WIN     | 2004        |           | R151          | 483877    |
| 50CC           | LIKE        | 2010        |           | R151          | 483877    |
| 125CC          | AGILITY     | 2004        |           | R017          | 292327    |
| 125CC          | BET&WIN     | 2004        |           | R151          | 483877    |
| 125CC          | DINK STREET | 2009        |           | R078          | 482906    |
| 125CC          | LIKE        | 2010        |           | R151          | 483877    |
| 300CC          | DINK STREET | 2010        |           | R078          | 482906    |
| <b>MBK</b>     |             |             |           |               |           |
| 50CC           | BOOSTER     | 1990        |           | R017          | 292327    |
| 50CC           | NITRO       | 1997        | 2012      | R017          | 292327    |
| 50CC           | OVETTO      | 1997        |           | R151          | 483877    |
| 50CC           | STUNT       | 2000        |           | R151          | 483877    |
| 125CC          | DOODO       | 2000        |           | R151          | 483877    |
| 125CC          | FLAME X     | 1997        | 2003      | R017          | 292327    |
| 125CC          | SKYCRUISER  | 2006        | 2009      | R155          | 482898    |
| 125CC          | SKYCRUISER  | 2010        |           | R080          | 482899    |
| 125CC          | SKYLINER    | 1998        |           | R038          | 482903    |
| 250CC          | SKYCRUISER  | 2005        | 2009      | R155          | 482898    |
| 250CC          | SKYCRUISER  | 2010        |           | R080          | 482899    |
| <b>PEUGEOT</b> |             |             |           |               |           |
| 50CC           | ELYSEO      | 1999        |           | R031          | 482904    |
| 50CC           | ELYSTAR     | 2003        |           | R031          | 482904    |
| 50CC           | LUDIX       | 2004        |           | R017          | 292327    |
| 50CC           | TKR         | 2004        |           | R017          | 292327    |
| 50CC           | VIVACITY    | 1999        |           | R151          | 483877    |
| 125CC          | ELYSEO      | 1999        |           | R031          | 482904    |
| 125CC          | ELYSTAR     | 2001        |           | R031          | 482904    |
| 125CC          | METROPOLIS  | 2013        |           | R173          | 493610    |
| 125CC          | SATELIS     | 2004        |           | R157          | 482902    |
| 250CC          | SATELIS     | 2004        |           | R157          | 482902    |
| 500CC          | SATELIS     | 2007        |           | R157          | 482902    |
| <b>PIAGGIO</b> |             |             |           |               |           |
| 50CC           | FLY         | 2005        |           | R151          | 483877    |
| 50CC           | ZIP         | 2000        |           | R151          | 483877    |
| 125CC          | FLY         | 2005        |           | R151          | 483877    |
| 125CC          | MP3 YOURBAN | 2012        |           | R085          | 491658    |

## AFFECTATION VÉHICULE DES TABLIERS

| Cylindrée      | Modèle       | Année début | Année fin | Modèle Tucano | Référence |
|----------------|--------------|-------------|-----------|---------------|-----------|
| <b>PIAGGIO</b> |              |             |           |               |           |
| 125CC          | VESPA GT     | 1999        | 2004      | R154          | 485630    |
| 125CC          | VESPA GTS    | 2005        |           | R154          | 485630    |
| 125CC          | X10          | 2013        |           | R096          | 493608    |
| 125CC          | X8           | 2004        | 2006      | R045          | 482900    |
| 125CC          | X8 STREET    | 2006        | 2008      | R045          | 482900    |
| 125CC          | X9 EVOLUTION | 2003        |           | R032          | 485641    |
| 125CC          | X-EVO        | 2007        |           | R045          | 482900    |
| 125CC          | ZIP          | 2000        | 2007      | R151          | 483877    |
| 250CC          | VESPA GTS    | 2005        |           | R154          | 485630    |
| 250CC          | X9 EVOLUTION | 2003        |           | R032          | 485641    |
| 300CC          | MP3 YOURBAN  | 2012        |           | R085          | 491658    |
| 300CC          | VESPA GTS    | 2008        |           | R154          | 485630    |
| 350CC          | X10          | 2013        |           | R096          | 493608    |
| 400CC          | X8           | 2004        | 2006      | R045          | 482900    |
| 400CC          | X-EVO        | 2007        |           | R045          | 482900    |
| 500CC          | X9 EVOLUTION | 2003        |           | R032          | 485641    |
| <b>SCOOTER</b> |              |             |           |               |           |
| 50CC           | UNIVERSEL    |             |           | R151          | 483877    |
| <b>SUZUKI</b>  |              |             |           |               |           |
| 125CC          | BURGMAN      | 2007        |           | R063          | 485631    |
| 125CC          | EPICURO      | 2001        |           | R151          | 483877    |
| <b>SYM</b>     |              |             |           |               |           |
| 50CC           | MOI          | 2005        |           | R151          | 483877    |
| 125CC          | GTS          | 2006        | 2011      | R077          | 482905    |
| 125CC          | GTS          | 2012        |           | R163          | 485632    |
| 250CC          | GTS          | 2006        | 2011      | R077          | 482905    |
| 250CC          | GTS          | 2012        |           | R163          | 485632    |
| 300CC          | GTS          | 2006        | 2011      | R077          | 482905    |
| 300CC          | GTS          | 2012        |           | R163          | 485632    |
| <b>YAMAHA</b>  |              |             |           |               |           |
| 50CC           | AEROX        | 1997        | 2012      | R017          | 292327    |
| 50CC           | BWS          | 1990        |           | R017          | 292327    |
| 50CC           | NEOS         | 1997        |           | R151          | 483877    |
| 50CC           | SLIDER       | 2000        |           | R151          | 483877    |
| 125CC          | CYGNUS X     | 1997        | 2003      | R017          | 292327    |
| 125CC          | MAJESTY      | 1998        |           | R038          | 482903    |
| 125CC          | TEOS         | 2000        |           | R151          | 483877    |
| 125CC          | X-MAX        | 2006        | 2009      | R155          | 482898    |
| 125CC          | X-MAX        | 2010        |           | R080          | 482899    |
| 250CC          | X-MAX        | 2005        | 2009      | R155          | 482898    |
| 250CC          | X-MAX        | 2010        |           | R080          | 482899    |
| 400CC          | X-MAX        | 2013        |           | R167          | 486273    |
| 500CC          | X-MAX        | 2008        | 2011      | R069          | 493609    |
| 530CC          | X-MAX        | 2012        |           | R089          | 485629    |



## TABLIER SCOOTER



292327

R017

- ↳ **Aprilia** Leonardo 125/150/250/300 | Sport City One 50/125 | SR
- ↳ **Benelli** 491 ST/RR, 49X 50 CC
- ↳ **Honda** Lead 100/110 | Vision 50/110
- ↳ **Kymco** Agility City | Agility City R16 200 | MovieXL 125/150
- ↳ **Malaguti** Phantom Max 200/250
- ↳ **MBK** Booster 50/100 | Evolis ->2013 | Flame 125 ->2003 | Forte | Mach 50 | Nitro 50/100 | Thunder 125/150 | Vertex | Waap
- ↳ **Peugeot** Ludix | V-Clic | X-fight 50/100
- ↳ **Sym** Jet Sport X 50 | Super Duke 125 | VS 125/150
- ↳ **Yamaha** Aerox 50/100 | BW'S/BWS 50/100/125 | Cygnus ->2003 | Equalis | Jog R 50 | Maxter 125/150 | Vity | XC 125/150



483877

R151

- ↳ **Honda** Zoomer
- ↳ **Kymco** Bet & Win 50/125/150/250 | Like 50/125/150/200
- ↳ **Malaguti** Centro 50 ->2008
- ↳ **MBK** Doodo 125/150 | Fizz | Flipper 125 2014-> | Ovetto 50/100 | Stunt
- ↳ **Peugeot** Vivacity 50/100/125,
- ↳ **Piaggio** Fly ->2012 | Fly 125 2013-> | Vespa ET2/ET4 | Zip 50/100,
- ↳ **Suzuki** UC Epicuro 125/150,
- ↳ **Sym** Mio 50/100,
- ↳ **Yamaha** Breeze | D'Elight 2013-> | Neo's 50/100 | Slider | Teo's



## TABLIER MAXI-SCOOTER



482904

R031

- ↳ **Peugeot** Elyseo 50/100/125/150 | Elystar 125/150
- ↳ **Suzuki** Burgman 250/400 ->2002
- ↳ **Sym** Joyride 125/150/200



485641

R032

- ↳ **Piaggio** X9 125/150/200/250/500



482903

R038

- ↳ **MBK** Skyliner 125/150/180
- ↳ **Yamaha** Majesty 125/150/180 (S compris)



# EQUIPEMENT VÉHICULE / EQUIPMENT SCOOTER

## TABLIER MAXI-SCOOTER

EQUIPEMENT



482900

R045

↳ Piaggio X8 | Xevo



485631

R063

↳ Suzuki Burgman 125/150/200  
2007->2013



493605

R068

↳ MBK Flame X 2004->  
↳ Yamaha Cygnus X 2004->



493609

R069

↳ Yamaha T-Max 500 2008->2011



493613

R076

↳ Sym Joyride Evo 125/200



482905

R077

↳ Sym GTS 125/250 | GTS EVO 300 |  
125 GTS EFI ->2011



482906

R078

↳ Kymco Dink Street (Super Dink)  
125/200/300ie



493611

R078

↳ Kymco Downtown 125/200/300



482899

R080

↳ MBK Skycruiser 125/250 2010->2013  
↳ Yamaha X-Max 125/150/250 2010->2013



485628

R082

↳ Honda PCX 125/150



491658

R085

↳ Piaggio MP3 125 à 500 ->2015



485629

R089

↳ Yamaha T-Max 530 2012->2016



## TABLIER MAXI-SCOOTER



487850

R094

↳ **Quadro** 350D 2012-> | 350S 2013-> |  
4 - Quattro | Parkour 2013->



493608

R096

↳ **Piaggio** X10 125/350/500 2012->



493612

R099

↳ **Honda** SH 125/150 2013->



485630

R154

↳ **Piaggio** Vespa GT/GTS/GTV/L 2007-> |  
Vespa Super Sport 125/300 | Vespa Super  
Sport GTS 125/300



482898

R155

↳ **MBK** Skycruiser ->2009  
↳ **Yamaha** X-Max 125/250 ->2009



482902

R157

↳ **Peugeot** Satelis 125/250/400/500 |  
Satelis 300 2013->



485632

R163

↳ **Sym** GTS 125/250/300 2012->



486273

R167

↳ **MBK** Evolis 2014->  
↳ **Yamaha** X-Max 125/250 2014-> |  
X-Max 400 2013->



493604

R171

↳ **Peugeot** Citystar 50/125



## TABLIER MAXI-SCOOTER



493610

R173



493607

R174



492532

R176C

↳ Peugeot Metropolis 3 roues 2014->

↳ Peugeot Django 50/125/150

↳ Honda Forza 125 2015->



495136

R180

↳ MBK Ocito 125 2016->

↳ Yamaha N-MAX 125 2016->



## HOUSSE DE PROTECTION ÉTANCHE INTÉRIEUR/EXTÉRIEUR

483075 sccoter, moto, cyclo, maxi-scooter, avec œillet antivol et sangle noir

483076 sccoter, moto, cyclo, maxi-scooter, avec œillet antivol et sangle gris



483075



483076



### HOUSSE DE PROTECTION ÉTANCHE INTÉRIEUR/EXTÉRIEUR

481188 scooter 50 sans pare-brise

327459 scooter avec pare-brise



481188



327459



### HOUSSE DE PROTECTION ÉTANCHE INTÉRIEUR/EXTÉRIEUR

481189 maxi-scooter-moto



### SUPPORT SMARTPHONE

492594 pour écran 4.3" (8x14cm) fixation rétroviseur

492593 pour écran 5.5" (9x16cm) fixation rétroviseur



### SUPPORT SMARTPHONE

497449 pour écran 5.5" (10x16cm) fixation rétroviseur

497577 pour écran 5.5" (10x16cm) fixation guidon



### SUPPORT VIGNETTE ASSURANCE

277294 plastique

292957 chrome

483688 carbone

494115 alu gris

494234 alu argent

495810 alu titane



277294



292957



483688



277294



494234



495810



# TOP-CASE/SACOCHÉ / TOP-CASE/BAGGAGE



**472501**

26L noir

- ↳ Idéal pour les scooters et les cyclomoteurs
- ↳ Charge maximale de 3kg
- ↳ Platine et kit de visserie compris
- ↳ Contenance : 1 casque intégral
- ↳ Dimensions: largeur 40cm, hauteur 28.2cm, profondeur 40.5cm



**492713**

29L noir

- ↳ Le complément idéal au scooter dernière génération
- ↳ Le système de fermeture pression offre plus de sécurité et de confort
- ↳ Platine et kit de visserie compris
- ↳ Charge maximale de 3kg
- ↳ Étanche et résistant aux impacts
- ↳ Contenance: 1 casque intégral et accessoires
- ↳ Dimensions: largeur 40cm, hauteur 30cm, profondeur 38cm



**492714**

33L noir

- ↳ Le système de fermeture pression offre plus de sécurité et de confort
- ↳ Platine et kit de visserie compris
- ↳ Charge maximale de 3kg
- ↳ Étanche et résistant aux impacts
- ↳ Contenance: 1 casque intégral et accessoires
- ↳ Dimensions: largeur 43cm, hauteur 31cm, profondeur 42cm



**496209**

34L noir

- ↳ Spécialement destiné au public urbain pour un usage quotidien
- ↳ Intègre une poignée ergonomique et un système de fermeture facile et confortable
- ↳ Platine et kit de visserie compris
- ↳ Renfort du mécanisme de fixation entre le top case et la platine
- ↳ Protection antivol: axe métallique sans trou et espace minimum entre le couvercle et le top case
- ↳ Contenance: 1 casque intégral et accessoires
- ↳ Dimensions: largeur 42cm, hauteur 31cm, profondeur 43cm



**496210**

34L noir couvercle carbone

- ↳ Spécialement destiné au public urbain pour un usage quotidien
- ↳ Intègre une poignée ergonomique et un système de fermeture facile et confortable
- ↳ Platine et kit de visserie compris
- ↳ Ergonomique: sans nervure entre charnières
- ↳ Renfort du mécanisme de fixation entre le top case et la platine
- ↳ Protection antivol : axe métallique sans trou et espace minimum entre le couvercle et le top case
- ↳ Contenance: 1 casque intégral et accessoires
- ↳ Dimensions: largeur 42cm, hauteur 31cm, profondeur 43cm



**492715**

39L noir

- ↳ Le système de fermeture pression offre plus de sécurité et de confort
- ↳ Platine et kit de visserie compris
- ↳ Charge maximale de 3kg
- ↳ Un design moderne avec un couvercle simili-carbone
- ↳ Contenance: 1 casque intégral et 1 casque jet
- ↳ Dimensions: largeur 51cm, hauteur 32cm, profondeur 43cm

## TOP-CASE/SACOCHÉ / TOP-CASE/BAGGAGE



472503

40L noir

- ↳ Idéal pour les maxi-scooters et les motos
- ↳ Platine et kit de visserie compris
- ↳ Charge maximale de 4kg
- ↳ Contenance: 1 casque intégral et 1 casque jet
- ↳ Dimensions: largeur 49.2cm, hauteur 29.6cm, profondeur 42.5cm



492716

45L noir

- ↳ Le système de fermeture pression offre plus de sécurité et de confort
- ↳ Platine et kit de visserie compris
- ↳ Charge maximale de 6kg
- ↳ Contenance: 2 casques intégraux
- ↳ Dimensions: largeur 56cm, hauteur 31cm, profondeur 41cm



## DOSSERET POUR TOP-CASE

488034 26L | 29L | 33L

479513 34L | 37L | 39L | 40L | 45L | 49L



488034



479513



## DOSSERET MAXI-SCOOTER POUR PASSAGER

482938 X MAX | SKYCRUISER 125 de 2005-&gt;2009

482940 PIAGGIO X8/X7 EVO 125/250



482938



482940



## SIÈGE ENFANT SCOOTER/MOTO KAPPA

481527 enfant de 5 à 8 ans avec sangles et crochets

481531 kit de fixation siège enfant KAPPA pour selle large

- ↳ Adaptable à la majorité des scooters et motos en circulation
- ↳ Assure aux enfants d'environ 5 à 8 ans une assise correcte en selle en évitant que ceux-ci ne glissent sur le côté
- ↳ Fourni avec deux "reposes-pieds" réglables
- ↳ Se fixe à la selle par des crochets appropriés avec régulation universelle



481527



481531

## PORTE BAGAGE/SUPPORT TOP CASE

|        |   |        |  |
|--------|---|--------|--|
| 490810 | NITRO   AEROX 2013->                      |        |    |
| 483472 | OVETTO   NEOS 50/100 ->2008               | noir   |    |
| 491682 | OVETTO   NEOS 2008-> 50/125               |        |    |
| 483465 | TYPHOON 50/125 2011-> APRILIA SR50 MOTARD | argent |    |
| 483459 | TYPHOON 50/80/125 ->2011                  | noir   |    |
| 483462 | STALKER                                   | noir   |    |
| 491686 | PEUGEOT KISBEE 2013->                     |        |    |
| 483463 | ZIP 2000-> 50/100/125                     | argent |    |
| 483464 | 50/100 SYM MIO rabattable                 | noir   |    |
| 491683 | 125 YAMAHA XMAX   SKYCRUISER 2010->       |        |    |
| 491684 | 530 YAMAHA TMAX                           |        |    |
| 491685 | 125 XMAX   SKYCRUISER   EVOLIS 2014->     |        |    |
| 491687 | 125/300 DINK STREET   DOWNTOWN 2009->     |        |    |
| 492245 | 125 CYGNUS X   FLAME X 2007->             |        |    |
| 495145 | 125 NMAX   OCITO 2015->                   |        |   |
| 495908 | 125 HONDA FORZA                           |        |  |
| 495909 | 125 YAMAHA   MBK TRICITY   TRIPTIK        |        |  |
| 495910 | 125 PIAGGIO MEDLEY                        |        |  |
| 495911 | 125 PEUGEOT CITYSTAR                      |        |  |
| 496742 | 350 QUADRO 2014->                         |        |  |



## PIÈCES DÉTACHÉES POUR TOP CASE

|        |                   |  |
|--------|-------------------|--|
| 492551 | platine noire     | pour top case SHAD 26L   29L   32L   33L   34L |
| 492552 | serrure complète  | pour top case SHAD 26L   29L                   |
| 492553 | barillet + 2 clés | pour top case SHAD jusqu'à 46L                 |
| 494305 | feu stop          | pour top case SHAD 26L   29L   33L             |



492551



492552



492553



494305



### SACOCHE CYCLO NOIR (PAIRE)

|      |               |            |
|------|---------------|------------|
| 8173 | ordinaire R40 | 33x28x14cm |
| 8174 | dos métal R40 | 33x28x14cm |
| 8176 | dos métal R50 | 36x28x14cm |
| 8180 | dos métal R80 | 43x33x16cm |



8173



8174



8176



8180



### SACOCHE CYCLO NOIR (PAIRE)

|        |               |            |
|--------|---------------|------------|
| 496150 | dos plastique | 33x28x14cm |
|--------|---------------|------------|



### TRINGLE SUPPORT SACOCHE / PORTE-BAGAGE

#### Tringle support saccoche

|        |  |
|--------|--|
| 496084 | 103 MVL fixation garde boue/armortisseur |
| 485345 | 103 SP   VOGUE   MVL   SPX arrière       |

#### Porte bagage

|        |                         |
|--------|-------------------------|
| 496083 | 103 MVL   VOGUE arrière |
|--------|-------------------------|



496084



485345



496083



### SANDOW

|        |   | Dimension | Dimension en extension | Diamètre | Résistance |
|--------|---|-----------|------------------------|----------|------------|
| 485380 | plat à crochet joubert en acier surmoulé                              | 80cm      | 120cm                  | 18mm     | 80kg       |
| 485381 | plat 3 brins à crochet joubert en acier surmoulé                      | 60cm      | 90cm                   | 9mm      | 55kg       |
| 485382 | plat à crochet joubert acier plastifié 5 cordes de couleurs assorties | 60cm      | 100cm                  | 9mm      |            |
| 485383 | à crochet joubert en acier surmoule x2                                | 80cm      |                        | 9mm      | 110kg      |
| 485389 | filet arrimage joubert 6 crochets                                     | 30x30cm   |                        | 5.4mm    |            |



485380



485381



485382



485383

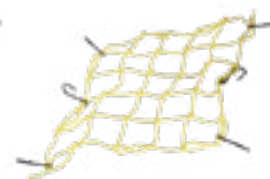

485389

Sélection  
**CGN**

## REMORQUE UTILITAIRE

**466766** fixation moyeu

- ↳ Longueur: 68cm
- ↳ Largeur: 48cm
- ↳ Hauteur: 26cm
- ↳ Roue: 16"
- ↳ Charge maximum: 40kg



Sélection  
**CGN**

## REMORQUE 3 EN 1 UTILITAIRE/CADDIE/SAC À DOS

**466766** avec sac amovible

- ↳ Longueur: 103cm
- ↳ Largeur: 51cm
- ↳ Hauteur: 40cm
- ↳ Roue: 12"
- ↳ Charge maximum: 22kg
- ↳ Barre en acier détachable
- ↳ Pneu: Kenda
- ↳ Cadre: acier robuste
- ↳ Fixation; fournie, sur tige de selle
- ↳ Dimensions du sac à dos:
  - Longueur: 60cm
  - Largeur: 51cm
  - Hauteur: 27cm
- ↳ Matière sac à dos: Nylon 600D



|                        |     |
|------------------------|-----|
| Immatriculation        | 658 |
| Lubrifiant             | 597 |
| Outillage              | 637 |
| Réparation/Maintenance | 625 |
| Visserie               | 652 |

### ↳ INFO + :

Retrouvez les informations sur les normes de viscosité et de qualité à la **page 624**.

## HUILE SYNTHÉTIQUE

↳ L'**huile synthétique** est une huile de performance supérieure, hautement raffinée, constituée d'une base et d'additifs. Elle est destinée aux moteurs dont la vitesse de rotation se situe **au-delà de 9000-10000 tours/min**. En effet, à ce régime, l'huile minérale est centrifugée, éjectée des parois du moteur. Des bases dispersantes sont donc utilisées dans les huiles de synthèse pour leur pouvoir fixant très élevé. Cela permet aux molécules d'huile d'adhérer fortement au piston, formant ainsi une couche lubrifiante. De plus, les huiles de synthèses résistent mieux au vieillissement et permettent d'espacer les vidanges.

### Utilisation :

- 2 temps en compétition :
  - Motos, motocross, enduro
  - Trial, Quad, Jet ski
  - Karting
  - Petits 2 temps tournant a haut régime (tronçonneuses, débroussailleuses)
- 4 temps en compétition :
  - Motos, motocross, enduro, vitesse, superbike, supermotard, quad, etc.
  - Cylindrées de plus de 600cc

## HUILE SEMI-SYNTHÉTIQUE

↳ L'**huile semi-synthétique** est une huile offrant une bonne alternative entre l'huile synthétique et l'huile minérale. Elle est composée de 35% d'huile synthétique et de 65% d'huile minérale. La base de celle huile est différente, c'est un solvant . Elle est destinée aux moteurs dont la vitesse de rotation **n'excède pas 9000 tours/min**.

### Utilisation :

- 2 temps en utilisation sportive ou loisir :
  - Motos, motocross, enduro
  - Trial, route, Quad, Jet ski
  - Moteurs fonctionnant à moyen régime (ulm, tondeuse)
- 4 temps en utilisation sportive ou loisir :
  - Motos, motocross, enduro, trial, tourisme, route, Quad, Jet ski...
  - Pétites et moyennes cylindrées, jusqu'à 600cc
  - Moteurs fonctionnant à moyen régime (ulm, tondeuses micro-tracteur)

## HUILE MINÉRALE

↳ L'**huile minérale** est le lubrifiant traditionnellement le plus utilisé. Elle provient du raffinage du pétrole brut et est destinée aux moteurs dont la vitesse de rotation est faible. L'huile minérale est le lubrifiant traditionnellement le plus utilisé.

## ADDITIFS

↳ Les **additifs** sont quant à eux des composés chimiques qui améliorent les propriétés des huiles telles que la viscosité et le point de coulement, ou bien lui confère des propriétés complémentaires : antirouille, anticorrosion, antifumée, anti-dépôts, détergente, anti-mousse...

**Les contraintes sur les moteurs de motos étant souvent supérieures à celles des moteurs de voiture, il est conseillé d'utiliser des huiles spécifiquement conçues pour les motos. Les huiles motos contiennent des additifs spécifiques pour les boîtes de vitesses intégrées au moteur. Les huiles voitures contiennent des additifs antifrictions, ceux-ci étant nuisibles à l'embrayage des motos.**



### HUILE MOTEUR 2 TEMPS RACING

|               |  |    |
|---------------|--|----|
| <b>317925</b> | Racing semi-synthétique                | 1L |
| <b>486588</b> | Racing semi-synthétique senteur fraise | 1L |
| <b>486592</b> | Racing 100% synthétique                | 1L |

- ↳ Répond aux normes JASO et API.
- ↳ L'huile moteur Racing 2T est à faible coefficient de frottement.
- ↳ Elle permet une réduction de l'usure des pièces mécaniques.
- ↳ Son film haute résistance limite les risques de grippage du piston tout en assurant une parfaite étanchéité du segment.
- ↳ Elle évite le gommage du segment et l'encrassement de la bougie.
- ↳ L'huile moteur Racing 2T permet d'améliorer les performances du moteur, une faible émission de fumée répondant aux normes anti-pollution.
- ↳ Il est possible d'utiliser l'huile en mélange ou en graissage séparé.
- ↳ Elle est compatible avec tous les carburants avec ou sans plomb.

↳ **Spécification produit: FD / TC**



317925

486588

486592

### HUILE MOTEUR 4 TEMPS

|               |                          |    |
|---------------|--------------------------|----|
| <b>493319</b> | Racing synthétique 5W40  | 1L |
| <b>486596</b> | Racing synthétique 10W40 | 1L |

- ↳ Répond aux normes JASO et API.
- ↳ L'huile moteur Racing 4T est réservée aux scooters.
- ↳ Elle est à faible coefficient de frottement. Elle permet une réduction de l'usure des pièces mécaniques.
- ↳ Son film haute résistance limite les risques de grippage du piston tout en assurant une parfaite étanchéité du segment. Elle évite le gommage du segment.
- ↳ L'huile moteur Racing 4T permet d'améliorer les performances du moteur. Il est possible de l'utiliser en mélange ou en graissage séparé.

↳ **Spécification produit: MA / SG**



493319

486596



**HUILE BOÎTE/TRANSMISSION****493320**      75W      | 1L

- ↳ L'huile de transmission DOPPLER est une huile synthétique spécialement développée pour le graissage des boîtes de vitesses de motos modernes.
- ↳ Très bonne compatibilité avec les embrayages, elle leur assure une bonne longévité.

**LIQUIDE DE FREIN DOT4****486599**      universel      | 250mL

- ↳ Le liquide DOT 4 s'emploie dans tous les systèmes hydrauliques de freinage montés avec tambours ou disques de freins.





## HUILE 2 TEMPS SCOOTER

### HUILE 2 TEMPS SCOOTER S2

**493972** 1L

**493973** 4L

**494185** 60L

- ↳ S2 est une huile 2 temps semi-synthétique
- ↳ Répond aux normes JASO et API
- ↳ Contient un colorant rouge et peut donc être clairement identifiée dans le carburant
- ↳ Le produit est adapté pour les motos de route et tout-terrain, scooters et véhicules tout-terrain utilisés dans des conditions normales
- ↳ Utilisez S2 pour les systèmes avec prémélange ou lubrification automatique
- ↳ Proportion de 2-4 %

↳ **Spécification produit: API TC/JASO FD/ISO-L-EGD**



493972



493973



494185

### HUILE 2 TEMPS SCOOTER TT

**477378** 1L

- ↳ Répond aux normes JASO et API.
- ↳ Contient un colorant rouge et peut donc être clairement identifiée dans le carburant
- ↳ TT Scooter est une huile moteur 2 temps à combustion propre, à faible dégagement de fumée et à hautes performances
- ↳ Elle réduit la formation de fumée et les dépôts de carbone
- ↳ Recommandée pour un usage sur route régulier et à haute performance
- ↳ Elle est adaptée pour les systèmes à prémélange et à injection
- ↳ Proportion recommandée : 2-4 %

↳ **Spécification produit: TT Scooter : API TC/TISI/JASO FD/ISO-L-EGD**



### HUILE 2 TEMPS SCOOTER TT SENTEUR FRAISE

**476534** 1L

- ↳ Répond aux normes JASO et API.
- ↳ Contient un colorant rouge et peut donc être clairement identifiée dans le carburant
- ↳ TT Scooter est une huile moteur 2 temps à combustion propre, à faible dégagement de fumée et à hautes performances
- ↳ Elle réduit la formation de fumée et les dépôts de carbone
- ↳ Recommandée pour un usage sur route régulier et à haute performance
- ↳ Elle est adaptée pour les systèmes à prémélange et à injection
- ↳ Proportion recommandée : 2-4 %

↳ **Spécification produit: TT Scooter : API TC/TISI/JASO FD/ISO-L-EGD**





## HUILE 2 TEMPS SCOOTER

# LUBRIFIANT / LUBRICANT

### HUILE 2 TEMPS SCOOTER CLASSIC

**494122** 1L

- ↳ Répond aux normes JASO et API
- ↳ Contient un colorant rouge et peut donc être clairement identifiée dans le carburant
- ↳ Classic Scooter est une huile pour scooter de première qualité
- ↳ Elle convient aux scooters Lambretta, Vespa et aux autres scooters 2 temps classiques et modernes, à prémélange ou à injecteur
- ↳ En utilisation régulière, elle offre une protection complète
- ↳ Proportion de 2-4 %



↳ **Spécification produit: API TC/JASO FD/ISO-L-EGD**

## HUILE 2 TEMPS MOTO

### HUILE 2 TEMPS MOTO TT SPORT

**476522** 1L

**476523** 4L

**493821** 20L

**492287** 60L

- ↳ Répond aux normes JASO et API
- ↳ Contient un colorant rouge et peut donc être clairement identifiée dans le carburant
- ↳ TT Sport est une huile moteur 2 temps à combustion propre et à hautes performances
- ↳ Elle réduit la formation de fumée et les dépôts de carbone
- ↳ Elle contrebalance l'encrassement des bougies d'allumage et prolonge la durée de vie du moteur



476522



476523



493821



492287

↳ **Spécification produit: API TC/TISI/JASO FD/ISO-L-EGD**

### HUILE 2 TEMPS MOTO ESTER TECH RS 959

**476715** 1L

- ↳ Ester Tech RS 959 est une huile moteur 100% synthèse entièrement synthétique avec des additifs Ester Tech révolutionnaires
- ↳ Répond aux normes JASO et API.
- ↳ Contient un colorant rouge et peut donc être clairement identifiée dans le carburant
- ↳ Le produit garantit une résistance du film et une absorption de la pression exceptionnelles, même dans les conditions de course les plus extrêmes
- ↳ Ester Tech RS 959 est particulièrement adaptée pour les moteurs à prémélange ou à injection 2 temps qui fonctionnent dans des conditions de course extrêmement difficiles
- ↳ Proportion recommandée : 2-4 %



↳ **Spécification produit: API TC+/JASO FD (Low Smoke)/ISO-L-EGD/Piaggio Hexagon/TISI**



## HUILE 2 TEMPS MOTO

### HUILE 2 TEMPS MOTO CASTOR R

493118 1L

- ↳ Castor R est une huile de ricin pure de la plus haute qualité, combinée à des additifs spéciaux
- ↳ Ce produit spécial est destiné aux motos 2 et 4 temps de compétition Grass Track et Speedway
- ↳ Castor R peut être mélangée avec du méthanol, du nitrométhane et de l'essence
- ↳ **Spécification produit: API TC/JASO FD/ISO-L-EGD**



### HUILE 2 TEMPS MOTO TTX

476520 1L

- ↳ TTX est une huile 100% synthèse 2 temps ultime intégralement synthétique et développée spécialement pour la conduite sur circuit.
- ↳ Recommandée pour les moteurs routiers hautes performances pour lesquels une huile intégralement synthétique est prescrite.
- ↳ TTX de composition unique à faible dégagement de fumée, réduit les dépôts de calamine, garantit une combustion ultra propre et protège toutes les pièces de moteur même en cas de conditions de fonctionnement extrêmes.



### HUILE 2 TEMPS MOTO TT TRIAL PRO SCENTED

497056 1L

- ↳ TT Trial Pro Scented est une huile 2 temps synthétique.
- Le système d'additifs spécial fournit les propriétés suivantes :
- ↳ Combustion plus propre et plus efficace
  - ↳ Protection exceptionnelle du moteur
  - ↳ Stabilité à haute température
  - ↳ Résistance exceptionnelle du film et au cisaillement
  - ↳ Réduit la consommation de carburant
  - ↳ Pas de dépôts sur les segments de piston et le système d'échappement
  - ↳ Excellente réaction du papillon des gaz (tiroir d'accélérateur), même dans des conditions humides
  - ↳ Performances optimales du moteur à long terme
  - ↳ Fiabilité maximale du moteur
  - ↳ Démarrage amélioré





## HUILE 2 TEMPS MOTO TOUT TERRAIN

### HUILE 2 TEMPS MOTO TOUT TERRAIN MX5

**484799** 1L

- ↳ MX5 est une huile entièrement synthétique haut de gamme pour moteur 2 temps tout-terrain
- ↳ Le produit est recommandé pour un usage dans des moteurs de motos Motocross et Enduro et a été intensivement testé sur les circuits du monde entier
- ↳ Grâce à sa composition synthétique et à son système d'additifs d'avant-garde, l'huile MX5 fournit une protection optimale à toutes les pièces vitales du moteur
- ↳ Elle évite aussi la formation de dépôts de carbone nuisibles sur les pistons, cylindres et systèmes de soupapes de puissance, tout en fournissant un film de protection durable dans toutes les conditions

↳ **Spécification produit: API TC/JASO FD**



### HUILE 2 TEMPS MOTO TOUT TERRAIN MX7

**484800** 1L

- ↳ MX 7 est une huile entièrement synthétique pour moteur 2 temps tout-terrain

Le système d'additifs de MX 7 fournit les propriétés suivantes :

- ↳ Plus de puissance
- ↳ Une combustion plus propre et plus efficace
- ↳ Une protection exceptionnelle du moteur
- ↳ Un régime élevé et une grande stabilité de température
- ↳ Une résistance exceptionnelle du film d'huile
- ↳ Une consommation de carburant réduite
- ↳ Aucune accumulation de dépôts
- ↳ Une réponse de l'accélérateur optimale, même dans des conditions humides
- ↳ Une performance et une fiabilité optimales du moteur
- ↳ Des caractéristiques de démarrage améliorées

↳ **Spécification produit: ISO-L-EGD/API TC+**



### HUILE 2 TEMPS MOTO TOUT TERRAIN MX9

**486825** 1L

- ↳ Ester Tech MX9 est une huile 2 temps, bleue, entièrement synthétique
- ↳ L'ajout du système révolutionnaire d'additifs Ester Tech garantit une lubrification sûre, même dans des conditions de course extrêmes
- ↳ Ester Tech MX9 a été exclusivement développée pour les motos de Grand Prix tout-terrain

↳ **Spécification produit: JASO FD/ISO-L-EGD/API TC+**





## HUILE 4 TEMPS SCOOTER

# LUBRIFIANT / LUBRICANT

### HUILE 4 TEMPS SCOOTER 5W40

**480807** 125mL

**476532** 1L

**492333** 20L

**477375** 60L

- ↳ Technomoto Scooter 4T 5W-40 est une huile moteur 4 temps synthétique
- ↳ Sa formule unique procure une protection qui est nécessaire pour les conditions de conduite Marche/Arrêt du trafic urbain
- ↳ Technomoto Scooter 4T 5W-40 a été créée exclusivement pour les scooters modernes 4 temps

↳ **Spécification produit: JASO MA2**



476532



480807



492333



477375

### HUILE 4 TEMPS SCOOTER 10W40

**476530** 1L

**496027** 60L

- ↳ Scooter 4T 10W-40 est une huile spéciale pour moteurs 4 temps
- ↳ Le produit contient sur une huile de base spécialement sélectionnée, combinée à des additifs synthétiques modernes
- ↳ Scooter 4T 10W-40 garantit ainsi un effet de nettoyage et un niveau de performance supérieurs dans une large gamme de températures

↳ **Spécification produit: JASO MA2/API SG**



476530



496027

### HUILE 4 TEMPS SCOOTER 15W-50

**491384** 60L

- ↳ Technomoto Sport 4 15W-50 est une huile moteur 4 temps semi-synthétique
- ↳ Le produit contient le système d'additifs révolutionnaire Pure Bike Technomoto et garantit une compatibilité totale avec les matériaux de friction d'embrayage modernes
- ↳ Technomoto Sport 4 15W-50 a été exclusivement créée pour les motos de tourisme et sportives

↳ **Spécification produit: API SL, JASO MA2**



### HUILE MOTEUR 4 TEMPS SCOOTER ECO 0W-30

**497093** 1L

- ↳ Scooter 4T+ ECO 0W-30 est une huile 100 % synthétique pour moteurs 4 temps
- ↳ Sa formule unique procure une protection qui est indispensable pour les arrêts/démarrages fréquents dans le trafic urbain dense
- ↳ Scooter 4T+ ECO 0W-30 a été développée exclusivement pour les scooters modernes à 4 temps qui répondent aux exigences des dernières normes Euro 4 en matière de gaz d'échappement
- ↳ Sa très faible viscosité et l'utilisation d'additifs de la dernière génération permettent à ce produit de faire économiser le carburant

↳ **Spécification produit: ACEA A1/B1-04, A5/B5-04**





## HUILE 4 TEMPS MOTO ENDURO

### HUILE 4 TEMPS MOTO ENDURO OFF ROAD NANO TECH 4+ 10W-40

493121 1L

- ↳ Off Road Nano Tech 4+ 10W-40 est l'huile 100 % synthétique pour moteur 4 temps la plus à la pointe créée par Putoline Oil
- ↳ Grâce aux huiles Nano Tech, la compatibilité avec les matériaux modernes de friction d'embrayage est totale et la mise en prise correcte de l'embrayage est inégalée
- ↳ **Propriétés :**
- ↳ Moteur et transmission très bien protégés contre l'usure
- ↳ Très faible consommation d'huile et excellente fluidité, même à basses températures
- ↳ Performance maximale et constante du moteur
- ↳ Très bonne capacité de nettoyage qualité constante pendant toute la durée de vie Off Road Nano Tech 4+ 10W-40
- ↳ Contient les additifs Pure Bike Nano Tech
- ↳ Convient particulièrement aux motos tout-terrain qui roulent dans des conditions difficiles

↳ **Spécification produit: JASO MA2, API SM**



### HUILE 4 TEMPS MOTO ENDURO OFF ROAD NANO TECH 4+ 10W-50

493120 1L

- ↳ Off Road Nano Tech 4+ 10W-50 est l'huile 100 % synthétique pour moteur 4 temps la plus à la pointe créée par Putoline Oil
- ↳ Grâce aux huiles Nano Tech, la compatibilité avec les matériaux modernes de friction d'embrayage est totale et la mise en prise correcte de l'embrayage est inégalée

Propriétés :

- ↳ Moteur et transmission très bien protégés contre l'usure
- ↳ Très faible consommation d'huile
- ↳ Excellente fluidité, même à basses températures
- ↳ Performance maximale et constante du moteur
- ↳ Très bonne capacité de nettoyage
- ↳ Bonne qualité constante pendant toute la durée de vie Off Road Nano Tech 4+ 10W-50
- ↳ Contient les additifs Pure Bike Nano Tech
- ↳ Cette huile moteur 100 % synthétique 4 temps convient particulièrement aux motos tout-terrain qui roulent dans des conditions difficiles

↳ **Spécification produit: API SM**



### HUILE 4 TEMPS MOTO ENDURO OFF ROAD 4+ 10W40 ESTER TECH

486705 1L

- ↳ Ester Tech Off Road 4+ est une huile entièrement synthétique pour moteur 4 temps de compétition
- ↳ L'ajout du système d'additifs révolutionnaire Ester Tech garantit une compatibilité totale avec les matériaux de friction d'embrayage modernes
- ↳ Ester Tech Off Road 4+ a été créée exclusivement pour les motos tout-terrain
- ↳ Elle garantit une durée de vie du moteur plus longue, même dans des conditions de course difficiles
- ↳ **Spécification produit: JASO MA2, API SL**





## HUILE 4 TEMPS MOTO ENDURO

### HUILE 4 TEMPS MOTO ENDURO OFF ROAD 4+ 10W50 ESTER TECH

486707 1L

- ↳ Ester Tech Off Road 4+ est une huile entièrement synthétique pour moteur 4 temps de compétition
  - ↳ L'ajout du système d'additifs révolutionnaire Ester Tech garantit une compatibilité totale avec les matériaux de friction d'embrayage modernes
  - ↳ Ester Tech Off Road 4+ a été créée exclusivement pour les motos tout-terrain
  - ↳ Elle garantit une durée de vie du moteur plus longue, même dans des conditions de course difficiles
- ↳ **Spécification produit: JASO MA2, API SL**



### HUILE 4 TEMPS MOTO ENDURO OFF ROAD 4+ 10W60 ESTER TECH

486709 1L

- ↳ Ester Tech Off Road 4+ est une huile entièrement synthétique pour moteur 4 temps de compétition
  - ↳ L'ajout du système d'additifs révolutionnaire Ester Tech garantit une compatibilité totale avec les matériaux de friction d'embrayage modernes
  - ↳ Ester Tech Off Road 4+ a été créée exclusivement pour les motos tout-terrain
  - ↳ Elle garantit une durée de vie du moteur plus longue, même dans des conditions de course difficiles
- ↳ **Spécification produit: JASO MA2, API SL**



### HUILE 4 TEMPS MOTO ENDURO OFF ROAD 10W40

486701 1L

- ↳ Ester Tech Off Road 10W-40 est une huile entièrement synthétique pour moteur 4 temps de compétition
  - ↳ L'ajout du système d'additifs révolutionnaire Ester Tech garantit une compatibilité totale avec les matériaux de friction d'embrayage modernes
  - ↳ Ester Tech Off Road 4+ 10W-40 a été créée exclusivement pour les motos tout-terrain
  - ↳ Elle garantit une durée de vie du moteur plus longue, même dans des conditions de course difficiles
- ↳ **Spécification produit: JASO MA2, API SL**







## HUILE 4 TEMPS MOTO

### HUILE 4 TEMPS MOTO NANO TECH 4+ 5W40

493116 1L

486692 4L

- ↳ Nano Tech 4+ est l'huile 100 % synthétique pour moteur 4 temps la plus à la pointe créée par Putoline Oil
- ↳ Grâce aux huiles Nano Tech, la compatibilité avec les matériaux modernes de friction d'embrayage est totale et la mise en prise correcte de l'embrayage est inégalée

Propriétés :

- ↳ Moteur et transmission très bien protégés contre l'usure
- ↳ Très faible consommation d'huile
- ↳ Excellente fluidité, même à basses températures
- ↳ Performance maximale et constante du moteur
- ↳ Très bonne capacité de nettoyage
- ↳ Bonne qualité constante pendant toute la durée de vie
- ↳ Nano Tech 4+ contient les additifs Pure Bike Nano Tech
- ↳ Convient particulièrement aux motos de route et de course qui roulent dans les conditions les plus difficiles

↳ **Spécification produit: JASO MA-2/API SM**



493116



486692

### HUILE 4 TEMPS MOTO NANO TECH 4+ 10W30

493119 1L

- ↳ Nano Tech 4+ est l'huile 100 % synthétique pour moteur 4 temps la plus à la pointe créée par Putoline Oil
- ↳ Grâce aux huiles Nano Tech, la compatibilité avec les matériaux modernes de friction d'embrayage est totale et la mise en prise correcte de l'embrayage est inégalée

Propriétés :

- ↳ Couleur bleu
- ↳ Moteur et transmission très bien protégés contre l'usure
- ↳ Très faible consommation d'huile
- ↳ Excellente fluidité, même à basses températures
- ↳ Performance maximale et constante du moteur
- ↳ Très bonne capacité de nettoyage
- ↳ Bonne qualité constante pendant toute la durée de vie
- ↳ Nano Tech 4+ contient les additifs Pure Bike Nano Tech
- ↳ Convient particulièrement aux motos de route et de course qui roulent dans les conditions les plus difficiles

↳ **Spécification produit: API SM, JASO MA2**





## HUILE 4 TEMPS MOTO

### HUILE 4 TEMPS MOTO NANO TECH 4+ 10W40

**492722** 1L

**492723** 4L

- ↳ Nano Tech 4+ est l'huile 100 % synthétique pour moteur 4 temps la plus à la pointe créée par Putoline Oil
- ↳ Grâce aux huiles Nano Tech, la compatibilité avec les matériaux modernes de friction d'embrayage est totale et la mise en prise correcte de l'embrayage est inégalée

Propriétés :

- ↳ Couleur bleu
- ↳ Moteur et transmission très bien protégés contre l'usure
- ↳ Très faible consommation d'huile
- ↳ Excellente fluidité, même à basses températures
- ↳ Performance maximale et constante du moteur
- ↳ Très bonne capacité de nettoyage
- ↳ Bonne qualité constante pendant toute la durée de vie
- ↳ Nano Tech 4+ contient les additifs Pure Bike Nano Tech
- ↳ Convient particulièrement aux motos de route et de course qui roulent dans les conditions les plus difficiles

↳ **Spécification produit: JASO MA2, API SM**



492722



492723

### HUILE 4 TEMPS MOTO NANO TECH 4+ 10W50

**492720** 1L

**492721** 4L

- ↳ Nano Tech 4+ est l'huile 100 % synthétique pour moteur 4 temps la plus à la pointe créée par Putoline Oil
- ↳ Grâce aux huiles Nano Tech, la compatibilité avec les matériaux modernes de friction d'embrayage est totale et la mise en prise correcte de l'embrayage est inégalée

Propriétés :

- ↳ Moteur et transmission très bien protégés contre l'usure
- ↳ Très faible consommation d'huile
- ↳ Excellente fluidité, même à basses températures
- ↳ Performance maximale et constante du moteur
- ↳ Très bonne capacité de nettoyage
- ↳ Bonne qualité constante pendant toute la durée de vie
- ↳ Nano Tech 4+ contient les additifs Pure Bike Nano Tech
- ↳ Convient particulièrement aux motos de route et de course qui roulent dans les conditions les plus difficiles

↳ **Spécification produit: API SM**



492720



492721



## HUILE 4 TEMPS MOTO

### HUILE 4 TEMPS MOTO ESTER TECH SYNTEC 4+ 10W40

**486716** 1L

**486718** 4L

- ↳ Ester Tech Syntec 4+ est une huile 100 % synthétique, au rendement supérieur, pour moteur de compétition 4 temps. Les huiles de base haut de gamme combinées au système d'additifs révolutionnaire
- ↳ Ester Tech assurent des performances exceptionnelles dans les domaines suivants, notamment :
  - ↳ Film lubrifiant très puissant, même dans les conditions les plus extrêmes
  - ↳ Performance maximale du moteur
  - ↳ Indice de viscosité très élevé et extrêmement stable
  - ↳ Fonctionnement optimal de l'embrayage à huile
  - ↳ Changement de rapport précis et souple
  - ↳ Protection supérieure contre l'usure
  - ↳ Consommation d'huile minimale grâce à une faible volatilité
- ↳ Ester Tech Syntec 4+ a été créée exclusivement pour les motos de route et de course modernes, high-tech, aux performances élevées

↳ **Spécification produit: JASO MA2, API SL**



486716



486718

### HUILE 4 TEMPS MOTO ESTER TECH SYNTEC 4+ 10W50

**486690** 1L

- ↳ Ester Tech Syntec 4+ est une huile 100 % synthétique, au rendement supérieur, pour moteur de compétition 4 temps.
- ↳ Les huiles de base haut de gamme combinées au système d'additifs révolutionnaire Ester Tech assurent des performances exceptionnelles dans les domaines suivants, notamment :
  - ↳ Film lubrifiant très puissant, même dans les conditions les plus extrêmes
  - ↳ Performance maximale du moteur
  - ↳ Indice de viscosité très élevé et extrêmement stable
  - ↳ Fonctionnement optimal de l'embrayage à huile
  - ↳ Changement de rapport précis et souple
  - ↳ Protection supérieure contre l'usure
  - ↳ Consommation d'huile minimale grâce à une faible volatilité
- ↳ Ester Tech Syntec 4+ a été créée exclusivement pour les motos de route et de course modernes, high-tech, aux performances élevées

↳ **Spécification produit: JASO MA2, API SL**





## HUILE 4 TEMPS MOTO

### HUILE 4 TEMPS MOTO ESTER TECH SYNTEC 4+ 10W60

486698 4L

- ↳ Ester Tech Syntec 4+ est une huile 100 % synthétique, au rendement supérieur, pour moteur de compétition 4 temps.
- ↳ Les huiles de base haut de gamme combinées au système d'additifs révolutionnaire Ester Tech assurent des performances exceptionnelles dans les domaines suivants, notamment :
  - ↳ Film lubrifiant très puissant, même dans les conditions les plus extrêmes
  - ↳ Performance maximale du moteur
  - ↳ Indice de viscosité très élevé et extrêmement stable
  - ↳ Fonctionnement optimal de l'embrayage à huile
  - ↳ Changement de rapport précis et souple
  - ↳ Protection supérieure contre l'usure
  - ↳ Consommation d'huile minimale grâce à une faible volatilité
- ↳ Ester Tech Syntec 4+ a été créée exclusivement pour les motos de route et de course modernes, high-tech, aux performances élevées



↳ **Spécification produit: JASO MA2, API SL**

### HUILE 4 TEMPS MOTO TECHNOMOTO SPORT 4 10W40

477376 1L

478989 4L

481360 60L

- ↳ Technomoto Sport 4 est une huile moteur 4 temps semi-synthétique
- ↳ Le produit contient le système d'additifs révolutionnaire Pure Bike Technomoto et garantit une compatibilité totale avec les matériaux de friction d'embrayage modernes
- ↳ Technomoto Sport 4 a été exclusivement créée pour les motos de tourisme et sportives

↳ **Spécification produit: API SL, JASO MA2**



477376



478989



481360

### HUILE 4 TEMPS MOTO TECHNOMOTO SPORT 4 15W50

486731 1L

- ↳ Technomoto Sport 4 est une huile moteur 4 temps semi-synthétique
- ↳ Le produit contient le système d'additifs révolutionnaire Pure Bike Technomoto et garantit une compatibilité totale avec les matériaux de friction d'embrayage modernes
- ↳ Technomoto Sport 4 a été exclusivement créée pour les motos de tourisme et sportives

↳ **Spécification produit: API SL, JASO MA2**





## HUILE 4 TEMPS MOTO

### HUILE 4 TEMPS MOTO TECHNOMOTO SPORT 4 20W50

482575 1L

- ↳ Technomoto Sport 4 est une huile moteur 4 temps semi-synthétique
- ↳ Le produit contient le système d'additifs révolutionnaire Pure Bike Technomoto et garantit une compatibilité totale avec les matériaux de friction d'embrayage modernes
- ↳ Technomoto Sport 4 a été exclusivement créée pour les motos de tourisme et sportives
- ↳ **Spécification produit: API SL, JASO MA2**



### HUILE 4 TEMPS MOTO S4 10W40

494119 1L

494120 4L

- ↳ S4 10W-40 est une huile moteur 4 temps semi-synthétique
- ↳ Le produit offre une protection totale dans des conditions de conduite normales
- ↳ S4 10W-40 est particulièrement adaptée pour les motos, scooters et véhicules tout-terrain modernes



494119



494120

### HUILE 4 TEMPS MOTO FORMULA V-TWIN 20W40

487520 60L

- ↳ Formula V-Twin 20W-40 4 temps est une huile moteur de moto de la gamme spéciale V-Twin
- ↳ La formule spéciale du produit répond aux exigences toujours croissantes des moteurs V-Twin 4 temps modernes
- ↳ Sa formule unique semi-synthétique dépasse les exigences des principaux fabricants et, dans des conditions normales d'utilisation, offre une protection complète pour votre moteur
- ↳ **Spécification produit: JASO MA2, API SL**





## HUILE 4 TEMPS MOTO

### HUILE 4 TEMPS MOTO NANO TECH OFF ROAD 4+ 10W60

494123 1L

- ↳ Off Road Nano Tech 4+ 10W-60 est l'huile 100 % synthétique de couleur bleue pour moteur 4 temps la plus à la pointe créée par Putoline Oil.
- ↳ Grâce aux huiles Nano Tech, la compatibilité avec les matériaux modernes de friction d'embrayage est totale et la mise en prise correcte de l'embrayage est inégalée

#### Propriétés :

- ↳ Moteur et transmission très bien protégés contre l'usure
- ↳ Très faible consommation d'huile
- ↳ Excellente fluidité, même à basses températures
- ↳ Performance maximale et constante du moteur
- ↳ Très bonne capacité de nettoyage
- ↳ Bonne qualité constante pendant toute la durée de vie Off Road Nano Tech 4+ 10W-60 contient les additifs Pure Bike Nano Tech.
- ↳ Cette huile moteur 100 % synthétique 4 temps convient particulièrement aux motos tout-terrain qui roulent dans des conditions difficiles

↳ **Spécification produit: JASO MA-2, API SM**



### HUILE 4 TEMPS MOTO FORMULA V-TWIN 20W-50

486693 1L

- ↳ Formula V-Twin 20W-50 4 temps est une huile moteur de moto de la gamme spéciale V-Twin.
- ↳ La formule spéciale du produit répond aux exigences toujours croissantes des moteurs V-Twin 4-temps modernes.
- ↳ Sa formule unique, semi-synthétique dépasse les exigences des principaux fabricants et offre une protection complète pour votre moteur dans des conditions normales d'utilisation, .

↳ **Spécification produit: API SL, JASO MA2**



### HUILE 4 TEMPS MOTO NANO TRANS GP

486700 1L

- ↳ Nano Trans GP est une l'huile 100 % synthétique de pointe.
- ↳ Grâce aux huiles Nano Tech, la compatibilité avec les matériaux modernes de friction d'embrayage est totale et la mise en prise correcte de l'embrayage est inégalée

#### Propriétés :

- ↳ Excellente protection contre l'usure
- ↳ Engagement d'embrayage inégalé
- ↳ Prolonge la durée de vie des plaques d'embrayage
- ↳ A une durée de vie plus longue et permet des changements d'huile réduits au moins de moitié
- ↳ Contient le système d'additifs Pure Bike Nano Tech

↳ **Spécification produit: API GL-1, GL-2, GL-3**





## HUILE DE BOÎTE/TRANSMISSION

### GEAR LIGHT 75W

476527 1L

- ↳ Gear Light est une huile de transmission moderne.
- ↳ La base synthétique, légère, protège les composants de la boîte de vitesses et garantit un changement de vitesse en douceur dans toutes les conditions et en particulier lorsque la température ambiante est faible.
- ↳ Gear Light convient à un usage sur route et sur circuit.

↳ **Spécification produit: API GL-1**



### GEAR MEDIUM 80W

476528 1L

- ↳ Gear Medium est une huile de transmission moderne.
- ↳ Le produit donne une excellente protection en cas d'utilisation sous des climats plus chauds.
- ↳ À des températures ambiantes supérieures à 20°C, le produit réduit la friction, délivrant une puissance maximale à la roue arrière.
- ↳ Gear Medium convient à un usage sur route et sur circuit.

↳ **Spécification produit: API GL-1**



### GEAR HEAVY 80W90

476529 1L

- ↳ Gear Heavy est une huile de transmission spéciale, contenant des additifs pour résister aux pressions extrêmes.
- ↳ Le produit est recommandé pour des transmissions universelles pour lesquelles une huile SAE 80W-90 est spécifiée.

↳ **Spécification produit: API GL-5, Mil-L-2105D**



### GEAR SAE 10W30

486063 500mL

- ↳ Special Moped Gear Oil est une huile de boîte de vitesses SAE 10W-30.
- ↳ Le produit convient aux vélomoteurs tels que les Saxonette, Tomos A3, Tomos 4L
- ↳ Yamaha, Puch Maxi, Sachs, Puch, Vespa, Kreidler et Zundapp.

↳ **Spécification produit: API SF/CC**





## HUILE DE BOÎTE/TRANSMISSION

### ATF-DEXRON III

493828 1L

ATF-Dexron III est une huile de transmission de qualité supérieure offrant les propriétés suivantes :

- ↳ Bonne propriétés de réduction de friction
- ↳ Haute stabilité thermique et à l'oxydation
- ↳ Garantit une longue durée de vie ATF Dexron III convient aux boîtes de vitesses 2 temps automatiques et synchronisées, transmissions assistées, convertisseurs de couple, systèmes d'asservissement et embrayages hydrauliques



### SCOOT GEAR OIL 75W90

476537 100mL

↳ Scoot gear 75W-90 est une huile de transmission synthétique très moderne spécialement créée pour les scooters

Des huiles de base synthétiques à faible viscosité et des additifs de pointe lui confèrent les propriétés suivantes :

- ↳ Bonnes propriétés « pression extrême » qui fournissent une protection supplémentaire contre l'usure
- ↳ Excellente résistance aux températures de fonctionnement élevées, ce qui garantit une plus longue durée de vie de l'huile
- ↳ Changements de rapport exceptionnels, même à des températures extrêmement hautes ou basses
- ↳ Évite le moussage

↳ **Spécification produit: API GL-5**



### RS75 75W80

486759 1L

↳ RS 75 est une huile de transmission de course. Ce produit unique, 100 % synthétique, contient des additifs spéciaux qui protègent contre les charges de cisaillement et de choc qui se produisent dans des conditions de course extrêmes.

↳ RS 75 a été développée exclusivement pour les motos de Grand Prix 2 et 4 temps.

↳ **Spécification produit: API GL-4/5**



### SPECIAL SCOOTER GEAR 75W-90

495342 125mL

↳ Special Scooter Gear Oil est une huile de transmission spéciale.

↳ Le produit lubrifie et protège la boîte de vitesses.

↳ Elle convient pour tous les scooters 2 temps modernes pour lesquels une huile SAE 75W-90 est recommandée.

↳ **Spécification produit: API GL-5**







## HUILE DE FOURCHE SAE

- ↳ Fork Oil est une huile de fourche SAE minérale destinée à une utilisation sur route normale
- ↳ Le produit est adapté pour les scooters et les cyclomoteurs avec une fourche classique ou inversée

### LIGHT SAE 5

492717 500mL



### MEDIUM SAE 10

492718 500mL



### HEAVY SAE 20

492719 500mL



## HUILE DE FOURCHE HPX

- ↳ HPX R est une huile de fourche de pointe
- ↳ Le produit est élaboré à partir d'huiles synthétiques de base spéciales, hautement raffinées.
- ↳ L'ajout d'additifs les plus à la pointe du progrès fait de l'huile HPX un produit de haute technologie pour une utilisation de niveau Grand Prix
- ↳ L'huile de fourche HPX évite la corrosion, l'oxydation, les fuites des joints et le moussage
- ↳ Elle est particulièrement adaptée pour les motos de Grand Prix qui ont à courir en enduro cross, sur piste, sur route et hors route

### HPX 2.5W

486751 1L



### HPX 5W

476538 1L



### HPX 7.5W

486753 1L



### HPX 10W

476539 1L



### HPX 15W

487030 1L



### HPX 20W

476540 1L





## LIQUIDE DE REFROIDISSEMENT

## LUBRIFIANT / LUBRICANT

## LIQUIDE DE REFROIDISSEMENT COOLANT

476549 1L

476550 60L

- ↳ Coolant NF est un liquide de refroidissement organique prêt à l'emploi.
- ↳ Des additifs anti-corrosion assurent une excellente protection de tous les métaux présents dans les moteurs, y compris l'aluminium et le magnésium.
- ↳ Le produit offre une protection contre le gel jusqu'à -38°C.
- ↳ Coolant NF convient pour toutes les motos de route et tout-terrain, les quads, scooters, karts et motoneiges.



476549



476550

## MAINTENANCE FREIN

## LIQUIDE DE FREIN DOT4 BRAKE FLUID

476557 250mL

486773 500mL

- ↳ DOT 4 Brake Fluid est un liquide de frein synthétique haut de gamme qui dépasse les exigences des constructeurs de motos

Mode d'emploi :

- ↳ Remplacez le liquide de frein tous les deux ans pour continuer à garantir un fonctionnement correct
- ↳ N'utilisez que DOT 4 Brake Fluid lorsque c'est spécifié
- ↳ Veuillez consulter votre manuel de l'utilisateur pour obtenir les spécifications correctes
- ↳ Peut être mélangé avec les liquides de frein synthétiques DOT 3 et DOT 5.1

- ↳ **Spécification produit: FMVSS 116 DOT 4, SAE J1703, ISO 4925**



476557



486773

## LIQUIDE DE FREIN DOT 5.1 BRAKE FLUID

494914 500mL

- ↳ Le liquide de freinage DOT 5.1 est un fluide synthétique de haute qualité qui dépasse les exigences des fabricants de motos.

Instructions d'utilisation:

- ↳ Remplacer le liquide de frein tous les deux ans pour continuer à garantir un fonctionnement correct
- ↳ Utilisez uniquement le fluide de frein DOT 5.1 lorsque spécifié
- ↳ Veuillez consulter votre manuel d'instructions pour les spécifications correctes
- ↳ Peut être mélangé avec du DOT 3 et DOT 4 synthétiques

- ↳ **Spécification produit: FMVSS 116 DOT 5.1, SAE J1703, ISO 4925**





## LUBRIFIANT CHAÎNE

### LUBRIFIANT O/X-RING

476535 500mL

- ↳ O/X-Ring Chainspray est un lubrifiant spécial pour chaînes
- ↳ Sa formule particulière donne au produit une résistance très efficace à des températures élevées. Et ses propriétés de pénétration et hydrofuges font que cet aérosol pour chaînes convient particulièrement pour lubrifier tous les points rotatifs et difficiles d'accès
- ↳ O/X-Ring Chainspray a été créé pour les chaînes ordinaires et à joints toriques/en X
- ↳ Bien secouer avant usage



### LUBRIFIANT DX11 CHAIN

493117 200mL

- ↳ DX11 Chain Spray est un lubrifiant de chaîne synthétique
- ↳ Sa formule unique, hydrofuge, pénètre profondément dans les maillons de la chaîne et dépose une couche protectrice
- ↳ DX11 adhère très bien et reste en place longtemps. Il offre une protection parfaite contre la corrosion et l'usure, réduit la friction et n'est pas salissant
- ↳ DX 11 Chain Spray est adapté pour des niveaux élevés de performance sur les chaînes ouvertes, à joints toriques et en X des motos de route et tout-terrain



## MAINTENANCE FILTRE À AIR

### ACTION FLUID

479506 1L

- ↳ Action Fluid est une huile pour filtre à air en mousse haut de gamme
- ↳ Elle convient pour une utilisation après que le filtre à air en mousse a été nettoyé avec Action Cleaner
- ↳ À n'utiliser que dans un endroit bien aéré, de préférence à l'air libre, en portant des gants et des lunettes de sécurité





## MAINTENANCE FILTRE À AIR

### ACTION FLUID BIO

**480185** 600mL

- ↳ Action Fluid Bio est une huile pour filtre à air en mousse haut de gamme biodégradable
- ↳ Le produit est adapté pour tous les filtres à air en mousse de haute qualité, double couche, à pores ouverts
- ↳ Elle peut être utilisée après le nettoyage avec Action Cleaner
- ↳ À n'utiliser que dans un endroit bien aéré, de préférence à l'air libre, en portant des gants et des lunettes de sécurité



### KIT ENTRETIEN

**480297**

- ↳ Action Kit contient tout ce dont vous avez besoin pour nettoyer et entretenir l'ensemble du filtre à air en mousse

Contenu :

- ↳ Action Cleaner 4 litres
- ↳ Un seau Action Cleaner de 10 litres avec couvercle
- ↳ Une grille pour le fond du seau : empêche le filtre à air d'entrer en contact avec la saleté déposée au fond du seau
- ↳ Action Fluid 1 litre
- ↳ Un seau Action Fluid de 3 litres avec couvercle
- ↳ 10 grammes de graisse céramique
- ↳ Autocollant de filtre Action
- ↳ Gants jetables



## CARBURATION

### OCTANE BOOSTER

**484706** 325mL

- ↳ Octane Booster augmente l'indice d'octane RON à la fois de l'essence sans plomb et au plomb
- ↳ Cela a un effet positif sur les performances du moteur, réduit le risque de cliquetis du moteur et fournit une couche de protection sur les sièges de soupape pour éviter les réparations coûteuses du moteur.
- ↳ Octane Booster convient aux moteurs à essence 4 temps et 2 temps et peut être utilisé sans danger avec des catalyseurs et des moteurs modifiés
- ↳ La dose maximale pour de meilleurs résultats est une bouteille d'Octane Booster pour 30 litres d'essence





## CARBURATION

### FUEL CONDITIONER

**486778** 325mL

- ↳ Fuel Conditioner est un produit de pointe qui protège le système d'alimentation. Il est inoffensif pour les catalyseurs et ne contient pas de chlore.
- ↳ Fuel Conditioner a les propriétés suivantes :
  - ↳ Restaure la puissance
  - ↳ Réduit la consommation de carburant
  - ↳ Assure un ralenti du moteur plus constant
  - ↳ Réduit l'émission de gaz d'échappement nocifs
  - ↳ Le moteur démarre plus facilement
  - ↳ Empêche le gel du système d'alimentation
- ↳ Mode d'emploi : Ajoutez toute la bouteille à 25 litres de carburant. Ajoutez une bouteille lors de deux pleins de carburant successifs, et ensuite tous les 5 000 km



### FUEL STABILIZER

**486779** 325mL

- ↳ Fuel Stabilizer est un produit de pointe qui protège le système d'alimentation.
- ↳ Si la moto n'est pas utilisée pendant un mois ou plus et si du carburant reste dans le réservoir, il existe un risque d'oxydation de l'essence.
- ↳ Le caoutchouc et la peinture (la saleté) se déposent ensuite dans le réservoir et sur des pièces importantes du carburateur.
- ↳ Cela provoque des difficultés au démarrage et des ratés du moteur. Fuel Stabilizer empêche ces problèmes.
- ↳ Mode d'emploi : Ajoutez une bouteille à 50 litres de carburant. Faites balancer la moto vers l'arrière et vers l'avant jusqu'à ce que le carburant et Fuel Stabilizer soient bien mélangés. Faites tourner le moteur pendant quelques minutes.



## MAINTENANCE EMBRAYAGE

### HUILE EMBRAYAGE MINÉRALE

**495339** 125mL

- ↳ Hydraulic Clutch Fluid est un fluide d'embrayage minéral. Il protège contre l'usure et l'oxydation. Hydraulic Clutch Fluid convient à Magura et à d'autres marques.
- ↳ **Spécification produit: DIN 51524-3 HVLDP**





GRAISSE

LUBRIFIANT / LUBRICANT

## LUBRIFIANT 1001 PENETRATING

476545 500mL

- ↳ Grâce à sa capacité de pénétration supérieure, Putoline Penetrating 1001 Spray convient à de nombreuses applications.
- ↳ Il pénètre et lubrifie en délogeant et en chassant l'humidité.
- ↳ Il nettoie et protège tous les métaux.
- ↳ Sa composition spéciale permet d'utiliser cet aérosol sur les motos, scooter, vélos, jet-skis, bateaux, voitures, serrures, charnières, tondeuses à gazon et moteurs, ainsi que pour la lubrification générale à domicile



## CERAMIC GREASE

494121 100g

- ↳ Une graisse lubrifiante haute température sans particules métalliques.

Sa formulation unique lui confère les propriétés suivantes:

- ↳ Plage de température très élevée (température maximale de 1500 ° C environ)
- ↳ Résistance haute pression
- ↳ Réduit le frottement dans les pièces mobiles
- ↳ Excellente protection contre la corrosion électrolytique (contact métal-métal où le métal le moins précieux est affecté).
- ↳ La graisse céramique est particulièrement adaptée pour: assemblage, démontage, composants du système ABS, composants de frein, bougies, capteurs lambda, composants d'échappement, connexion de métaux différents, composants exposés à des températures très élevées.



## DISTRIBUTEUR

478785 pompe pour fut 60L et 200L

492334 robinet pour fut plastique 20L

494922 pompe pour pot savon de 4.5kg



478785



492334



494922

## GRAISSE

478467 blanche multi-usage 600g

478466 racing multi-usage au lithium EP2 600g



478467



478466

## DOSEUR ET DISTRIBUTEUR



## HUILE BOÎTE/TRANSMISSION GEAR SAE 10W30

494168 1L



## LUBRIFIANT MULTIFONCTION

|        |                                  |           |
|--------|----------------------------------|-----------|
| 7020   | aérosol                          | 200mL     |
| 482311 | aérosol avec jet double position | 250mL     |
| 475170 | aérosol                          | 400mL     |
| 478214 | aérosol avec jet double position | 500mL     |
| 479676 | présentoir de 36 aérosols        | 200mL x36 |
| 278847 | bidon, spray non fourni          | 5L        |
| 485121 | bidon, spray non fourni          | 25L       |



7020



482311



479676



475170



478214



278847



485121

- ↳ Le produit multifonction WD-40® protège le métal de la rouille et de la corrosion, s'insère dans les parties coincées, repousse l'humidité et lubrifie quasiment tout.
- ↳ Il élimine même la graisse, la saleté et plus encore de la plupart des surfaces.
- ↳ Recommandé pour: outils et équipement de jardinage, bornes de batterie, bougie d'allumage, cadres de vélos, serrures et charnières de portes, outils électriques, moteurs, alliages, échappements



## LUBRIFIANT AU SILICONE

460449 250mL

- ↳ Cette solution incolore dispose d'une formule efficace n'attirant pas la saleté et fournissant une excellente lubrification tout en protégeant contre l'humidité. Le Lubrifiant au Silicone empêche les pièces mobiles de bloquer et résiste aux fortes pressions et aux températures élevées

Avantages du produit:

- ↳ Supporte des températures allant de -35°C à +200°C
- ↳ Extrêmement efficace pour prolonger la durée d'utilisation des composants en caoutchouc.
- ↳ Conçu pour résister aux fortes pressions
- ↳ Fournit une excellente lubrification.
- ↳ N'attire pas la saleté.
- ↳ Protège les composants de l'humidité.





### LUBRIFIANT SUPER DÉGRIPPANT

460448 250mL

↳ Cette puissante solution à action rapide pénètre en peu de temps dans les zones difficiles à atteindre et desserre rapidement les fixations grippées ainsi que les pièces mobiles bloquées ou rouillées. Excellente résistance à l'eau.

Avantages du produit :

- ↳ Supporte des températures allant de -20°C à +90°C.
- ↳ Pénètre rapidement dans les zones difficiles à atteindre.
- ↳ Desserre rapidement les fixations grippées ainsi que les pièces mobiles bloquées ou rouillées.



### LUBRIFIANT CHÂÎNE ET CABLE

479727 250mL

↳ Ce produit apporte une lubrification et une protection durables à la chaîne et est compatible avec les joints toriques en O, X et Z. Son exceptionnelle action longue durée le rend particulièrement adapté aux environnements secs. De plus, il sèche rapidement et dispose d'excellentes propriétés anti-éclaboussures. Une utilisation régulière aide à entretenir la performance et la durée d'utilisation de la chaîne.



### LUBRIFIANT 3 EN UN

475171 250mL

Ce produit à la formulation professionnelle a trois propriétés complémentaires:

- ↳ Hydrofuge, il chasse l'humidité et protège de la rouille
- ↳ Dégrissant, son ultra fluidité lui permet une pénétration rapide
- ↳ Lubrifiant, sans encrasser



### GRAISSE

491475 variateur

40g







## GRAISSE

|               |  |      |
|---------------|--|------|
| <b>490731</b> | multi-usage pour pompe à graisse               | 400g |
| <b>490732</b> | pompe à graisse avec flexible et agrafe 4 mors |      |



490731



490732



## DOSEUR

|               |                    |
|---------------|--------------------|
| <b>451421</b> | graisseur de câble |
|---------------|--------------------|



## DOSEUR HUILE/RÉCUPÉRATEUR DE FLUIDE

|               |              |       |
|---------------|--------------|-------|
| <b>496369</b> | avec bouchon | 250mL |
|---------------|--------------|-------|



## DOSEUR HUILE / RÉCUPÉRATEUR DE FLUIDE

|               |              |       |
|---------------|--------------|-------|
| <b>486950</b> | avec bouchon | 250mL |
|---------------|--------------|-------|



## DOSEUR

|               |   |
|---------------|---|
| <b>467537</b> | doseur huile 500mL gradué en % et mL avec bouchon verseur et obturateur |
| <b>479181</b> | doseur huile gradué éprouvette  |
| <b>462422</b> | doseur huile minimax 2 éprouvettes 100mL et 500mL graduées en % et mL   |
| <b>490735</b> | doseur huile gradué 5L  |



467537



479181



462422



490735

## NORME DE VISCOSITÉ

### NORME SAE

↳ Il s'agit d'une norme établie par la **Society of Automotive Engineering**. La viscosité détermine la résistance à l'écoulement de l'huile, en fonction de la température. Les huiles mono grade ont une seule viscosité, par exemple 10W. Les huiles multigrades possèdent une plage de viscosité par exemple 20W50. Le premier chiffre indique la viscosité à froid. Une huile notée 0W (W pour Winter, hiver en Anglais) reste liquide jusqu'à -35°C. Elle ira donc plus vite dans le circuit de graissage pour tout lubrifier. Le second chiffre indique la viscosité à chaud (mesurée à 100°C). Elle indique la résistance de l'huile et sa capacité à résister à des températures élevées. En théorie, plus le premier chiffre est bas (jusqu'à 0) et plus le second chiffre est haut (jusqu'à 60), meilleures sont les performances.

## NORME DE QUALITÉ

### NORME API

↳ L'**American Petroleum Institute** a établi un classement des huiles en fonction de plusieurs critères comme le pouvoir dispersif, de détergence, de résistance à l'usure ou de protection antioxydant, anticorrosion, ect. En fonction de ses performances, l'huile hérite d'une lettre après le S (pour Service) pour les moteurs essence 4 temps : SA, SB... SH, SJ, SL. Plus cette lettre est éloignée dans l'alphabet meilleures sont les performances. Les huiles pour moteurs 2 temps doivent satisfaire des exigences supplémentaires: tenue à plus haute température, solubilité dans l'essence, brûler sans dégager de fumée et sans produire de dépôt-TA (TSC1), TB (TSC2) et TC (TSC3). Les moteurs de deux-roues doivent aujourd'hui utiliser des huiles de catégorie API TC.

### AGRÉMENT JASO

↳ C'est la **Japanese Automotive Standard Organisation** qui attribue ce label après analyse de l'huile.

↳ **2 temps**: Le niveau le plus élevé pour une huile 2 temps est JASO FD. Pour qu'un lubrifiant 2 temps obtiennent la norme JASO FD, il doit être anti-dépôt, antifumée et avoir subi avec succès les tests de lubrification et de détergence.

↳ **4 temps**: Le niveau le plus élevé pour une huile 4 temps est JASO MA. Pour qu'un lubrifiant 4 temps obtienne la norme JASO MA, il doit répondre aux exigences les plus sévères en terme de lubrification en tenant compte de la spécificité de la moto où généralement l'embrayage baigne dans l'huile (test anti-glissement et friction). Tout dernièrement, une norme plus stricte est apparue : JASO MA2.

## RÉPARATION PNEUMATIQUE



### RÉPARATION PNEUMATIQUE

#### Bombe anti-crevaisson

|        |                       |       |
|--------|-----------------------|-------|
| 5051   | scooter et moto       | 200ml |
| 388569 | scooter, moto et auto | 300ml |

#### Liquide préventif

|        |                         |       |
|--------|-------------------------|-------|
| 455253 | liquide anti-crevaisson | 250ml |
|--------|-------------------------|-------|

#### Mèche intérieur réparation pneu

|        |                                |     |
|--------|--------------------------------|-----|
| 482762 | A3, tige Ø3.5mm, rustine Ø23mm | x5  |
| 211273 | A3, tige Ø3.5mm, rustine Ø23mm | x50 |
| 482763 | A6, tige Ø7mm, rustine Ø40mm   | x4  |
| 215499 | A6, tige Ø7mm, rustine Ø40mm   | x40 |

#### Cheville

|        |  |     |
|--------|--|-----|
| 210205 | recharge cheville réparation pneu      | x40 |
| 210197 | nécessaire de réparation pneu cheville | x25 |

#### Réparation vulcanisation

|        |                   |      |
|--------|-------------------|------|
| 211235 | spécial ciment BL | 30g  |
| 211227 | spécial ciment BL | 70g  |
| 211216 | spécial ciment BL | 225g |

#### Détecteur de fuite

|        |                           |       |
|--------|---------------------------|-------|
| 211240 | type 1000 bulles, aérosol | 400mL |
|--------|---------------------------|-------|

#### Meule réparation pneu

|        |                 |       |
|--------|-----------------|-------|
| 211182 | pièce sphérique | Ø40mm |
|--------|-----------------|-------|

#### Produit étanchéité

|        |   |    |
|--------|---|----|
| 211201 | stop fuite Bead Sealer pour pneu tubeless | 1L |
|--------|---|----|

#### Rapeur

|        |                         |       |
|--------|-------------------------|-------|
| 281164 | buffer chimique aérosol | 500mL |
|--------|-------------------------|-------|



5051



455253



482762



210205



211235



211240



211182



211201



281164



### PINCEAU

|        |                  |
|--------|------------------|
| 211288 | pour pâte à pneu |
|--------|------------------|



## RÉPARATION PNEUMATIQUE



## PÂTE À PNEU

|        |         |       |  |
|--------|---------|-------|--|
| 476554 |         | 3.5kg |  |
| 211197 | blanc   | 1kg   |  |
| 491462 | noir    | 1kg   |  |
| 492376 | blanche | 1kg   |  |



476554



211197

## DÉMONTE PNEU

|        |                      |                   |    |  |
|--------|----------------------|-------------------|----|--|
| 482664 | fusil, professionnel | 2x350mm + 1x240mm | x3 |  |
| 465276 | cyclo, professionnel | 240mm             | x3 |  |
| 449966 | moto, professionnel  | 200mm             | x3 |  |
| 7560   | cyclo, forge         | 4x150mm           | x1 |  |
| 483477 | moto, professionnel  | 300mm             | x3 |  |



## PROTECTION DE JANTE

494245 x3



## VALVE

|        |  |  |
|--------|--|--|
| 484971 | outil réparation valve type schrader avec démonte obus, tire valve |  |
| 480442 | démonte obus de valve longueur 95mm                                |  |
| 483333 | tire valve jante tubeless  |  |



## PISTOLET DE GONFLAGE

215298 avec manomètre



## RÉPARATION PNEUMATIQUE



### EMBOUT DE GONFLAGE LAITON SCHRADER TYPE MICHELIN

- 483140** pour flexible Ø5mm
- 483141** pour flexible Ø7mm



483140

483141



### CONTRÔLEUR DE PRESSION DIGITAL

**494025**

- ↳ Adaptable Schrader et presta
- ↳ Pression maximum 160 PSI / 11 Bars
- ↳ Précision +/-2%
- ↳ Arrêt automatique entre 30 et 50 secondes



### CONTRÔLEUR DE PRESSION DIGITAL SPORT

**495335**

- ↳ Pression maximum 150 PSI
- ↳ Embout et lecteur éclairés



### CONTRÔLEUR DE PRESSION TWIN GRAPH

**243373**

- ↳ Valve universelle
- ↳ Pression maximum 160 PSI / 11 Bars
- ↳ Précision 0.15 Bar
- ↳ Dimensions: 100x45mm
- ↳ Poids : 37g



### NÉCESSAIRE DE RÉPARATION PNEU TUBELESS

- |               |                         |    |
|---------------|-------------------------|----|
| <b>440129</b> | mèche, tresse           | x3 |
| <b>171628</b> | mèche, tresse           | x5 |
| <b>482670</b> | outil, mèche x5, CO2 x3 |    |



### NÉCESSAIRE DE RÉPARATION PNEU TUBELESS

- |               |               |    |
|---------------|---------------|----|
| <b>495559</b> | mèche, tresse | x5 |
|---------------|---------------|----|



## RÉPARATION PNEUMATIQUE

Sélection  
**CGN**

## NÉCESSAIRE DE RÉPARATION PNEU

|               |                             |     |
|---------------|-----------------------------|-----|
| <b>440130</b> | mèche, tresse longueur 10mm | x50 |
| <b>496099</b> | mèche intérieur Ø3mm        | x20 |
| <b>496100</b> | mèche intérieur Ø6mm        | x20 |



## RÉPARATION CHAMBRE À AIR

REMA  
**TIP**  
**TOP**

## NÉCESSAIRE DE RÉPARATION

|             |                             |     |
|-------------|-----------------------------|-----|
| <b>5012</b> | rustine chambre à air TT10  | x5  |
| <b>5013</b> | rustine chambre à air TT11  | x7  |
| <b>5015</b> | rustines Combibox n°0 Ø30mm | x50 |
| <b>5016</b> | rustines Combibox n°1 Ø35mm | x60 |
| <b>5017</b> | rustines Combibox n°2 Ø45mm | x50 |



slime

## NÉCESSAIRE DE RÉPARATION

|               |                                   |
|---------------|-----------------------------------|
| <b>495558</b> | pneu moto, liquide anti crevaison |
|---------------|-----------------------------------|

Sélection  
**CGN**

## NÉCESSAIRE DE RÉPARATION

|             |                                  |
|-------------|----------------------------------|
| <b>5005</b> | rustine bleu en rouleau 75x930mm |
|-------------|----------------------------------|

REMA  
**TIP**  
**TOP**

## COMPRESSEUR PAINAIR

**494939**

- ↳ Pression maximal: 116 PSI / 8 Bars
- ↳ Bruit: 40 décibels
- ↳ Transport facile
- ↳ Capacité 4L
- ↳ Hauteur: 46cm
- ↳ Longueur: 45cm



## PÂTE ÉTANCHÉITÉ

**LOCTITE**

### PÂTE À JOINT 510

279134 25mL

- ↳ Résistant aux températures élevées
- ↳ Plans de joint métalliques usinés rigides
- ↳ S'adapte aux irrégularités de la surface des plans et aux rayures n'excédant pas 0.25mm
- ↳ Améliore la capacité de couple pour les plans assemblés



**LOCTITE**

### PÂTE À JOINT SILICONE BLEU 5926

279168 100g

484613 40mL

- ↳ Produit d'étanchéité silicone flexible polyvalent
- ↳ Utilisable sur des pièces métalliques, plastiques et pièces peintes
- ↳ Résiste aux vibrations ainsi qu'aux dilatations et contraintes thermiques
- ↳ Température d'utilisation : -55°C à +200°C



**LOCTITE**

### PÂTE À JOINT SILICONE GRIS 5135

279172 40mL

- ↳ Produit d'étanchéité pour plans de joints flexibles
- ↳ Excellente résistance au glycol
- ↳ Résistant à l'huile
- ↳ Numéro un pour la santé et la sécurité
- ↳ Température d'utilisation : -55°C à +250°C



**LOCTITE**

### PRODUIT ANTI-FUITE POUR RADIATEUR

484614 250mL

- ↳ Le produit colmate les fuites grâce aux particules métalliques en dispersion
- ↳ Produit compatible avec tous les liquides de refroidissement en circuit fermé
- ↳ Traite jusqu'à 10L
- ↳ La vidange du radiateur est inutile après utilisation



Sélection  
**CGN**

### PÂTE

|        |   |       |      |
|--------|---|-------|------|
| 2374   | pâte à joint CAF1   | rouge | 100g |
| 168917 | pâte à joint CAF4   | blanc | 100g |
| 317820 | pâte étanchéité montage pot échappement à appliquer sur la porte de joint |       | 170g |
| 481487 | pâte à joint ELRING 300°  | gris  | 70mL |
| 481488 | pâte à joint ELRING 300°  | rouge | 70g  |



## COLLE, RUBAN ADHÉSIF

**LOCTITE****COLLE SUPER GLUE 401**

279005 3g

492217 5g conditionnement atelier

- ↳ Adhésif instantané universel
- ↳ Très haute résistance sur assemblages à jeu faible
- ↳ Parfait pour les réparations rapides ou pour tous types de réparation d'urgence
- ↳ Pour le collage d'une large gamme de substrats similaires ou différents: métaux, caoutchouc, bois, carton, céramique, plastiques

**LOCTITE****COLLE BI-COMPOSANTS INSTANTANÉE PLASTIQUE 3090**

484616 10g

- ↳ Prise rapide
- ↳ Comble les jeux jusqu'à 5 mm
- ↳ Formule gel : sans coulure pour application verticale ou à l'envers
- ↳ Application précise et propre grâce à la seringue
- ↳ Résiste aux températures allant de -40 °C à +80 °C
- ↳ Parfait pour les réparations rapides de pièces plastiques cassées ou pour tous types de réparation d'urgence
- ↳ Excellent pouvoir de collage sur tous les substrats communs

**LOCTITE****COLLE BI-COMPOSANTS RÉPARATION PLASTIQUE 9225**

492203 50mL

- ↳ Recommandé pour les zones de réparation de plus de 7 cm
- ↳ Excellente sablage
- ↳ Peignable avec tous les systèmes de peinture automobile

**LOCTITE****FREIN FILET RÉSISTANCE NORMALE 243**

279010 5mL

- ↳ Empêche le desserrage des assemblages sous contraintes de vibrations telles que les vis de pompes, de carters de boîte de vitesses ou de presses
- ↳ Adapté à tous les métaux, y compris les substrats passifs
- ↳ Conçu pour tolérer une légère contamination par huiles industrielles
- ↳ Permet le désassemblage avec des outils manuels pour l'entretien

**LOCTITE****FREIN FILET RÉSISTANCE MOYENNE 248**

484617 9g

- ↳ Le format bâtonnet évite les bavures
- ↳ Empêche le desserrage des assemblages sous contraintes de vibrations
- ↳ Adapté à tous les métaux, y compris les substrats passifs
- ↳ Conçu pour tolérer une légère contamination par huiles industrielles
- ↳ Permet le désassemblage avec des outils manuels





## COLLE, RUBAN ADHÉSIF

**LOCTITE**

### FREIN FILET RÉSISTANCE FORTE 271

484618 5mL

- ↳ Faible viscosité à résistance élevée
- ↳ Produit fluorescent qui permet d'être contrôlé
- ↳ Empêchent les mouvements, desserrages, fuites et phénomènes de corrosion indésirables
- ↳ Étanchéité des filetages qui permet le perçage



**LOCTITE**

### FIXATION ROULEMENT BLOCPRESSE 648

279058 5mL

279081 24mL

- ↳ Résistant aux températures élevées
- ↳ Conçu pour tolérer une légère contamination par huiles industrielles
- ↳ Haute résistance sur tous les métaux, y compris les substrats passifs
- ↳ Idéal pour la fixation des assemblages avec jeu ou serrés



**LOCTITE**

### MASTIC CARROSSERIE UNIVERSELLE PLUS DURCISSEUR

484615 1.75kg

- ↳ Adhésif multiusage
- ↳ Bonne résistance aux chocs
- ↳ Idéal pour le collage de matériaux différents, tels que le PVC, les produits phénoliques et acryliques
- ↳ Viscosité moyenne à élevée



**LOCTITE**

### EPOXY ACIER POXYMATIC RECHARGE MATIÈRE 3450

279115 24mL

- ↳ Application facile et rapide à température ambiante
- ↳ Idéal pour la réparation et le collage de pièces en acier
- ↳ Développe un fort pouvoir de fixation



**LOCTITE**

### EPOXY ALU POXYMATIC RECHARGE MATIÈRE 3455

279120 24mL

- ↳ Viscosité élevée, bonne résistance à l'affaissement
- ↳ Réparation ou remise en état de pièces métalliques endommagées ou usées
- ↳ Adhésif structural



**HPX**

### RUBAN ADHÉSIF AMÉRICAIN HPX MULTI-RÉPARATION

288279 rouleau



Sélection  
**CGN**

### COLLIER RISLAN PLASTIQUE NOIR (X100)

479106 type sigma court 2.5x95mm

479105 type sigma long 2.6x200mm



## ENTRETIEN, NETTOYANT



## NETTOYANT AÉROSOL CARBURATEUR INJECTION

**476544** aérosol 500ml

- ↳ Carburettot Cleaner Spray de Putoline est composé d'un amalgame complexe de solvants spéciaux et est préconisé pour tous les types de carburateurs.
- ↳ Il élimine le dépôt dans le carburateur et sur le starter, l'aiguille et les gicleurs.
- ↳ Il rétablit la performance du moteur en éliminant les à-coups de ralenti et le calage du moteur et optimise la consommation de carburant.



## NETTOYANT CARROSSERIE SPÉCIAL COULEUR MAT, CARBONE, PLASTIQUE

**492359** aérosol 500ml

- ↳ Matt Wax est une cire d'avant-garde, à base d'eau.
- ↳ Sa composition spéciale la rend adéquate à être appliquée sur une peinture mate, du métal, de l'aluminium, du titane, du carbone et du plastique.
- ↳ Elle fournit une excellente protection et elle renforce la couleur d'origine.



## NETTOYANT POUR CHAÎNE

**476547** aérosol 500ml

- ↳ Le dégraissant Chain&Engine Degreaser Spray de Putoline est spécialement élaboré pour les motos.
- ↳ Sa formule unique agit rapidement en éliminant les dépôts lourds d'huile et de graisse de toutes les zones contaminées dont les chaînes, pignons, moteurs, châssis et tous les autres composants de la moto.
- ↳ Il est soluble dans l'eau et ne laisse pas de résidu.



## NETTOYANT COMPLET PUT OFF BIKE CLEANER

**486756** spray 1L

- ↳ Put Off Bike Cleaner est un nettoyant polyvalent ultra efficace pour les motos, les quads, les vélos, etc.

La formule concentrée, qui comprend les composants Nano Tech, fournit les propriétés suivantes:

- ↳ Garantit un nettoyage sûr et puissant
- ↳ Fournit une protection durable
- ↳ Est également adapté à des surfaces délicates telles que le magnésium, les éléments anodisés et l'aluminium
- ↳ Empêche l'adhérence de la saleté



## ENTRETIEN, NETTOYANT



### NETTOYANT CONTACT SPÉCIAL COMPOSANTS ÉLECTRIQUES

**476543** 500mL

- ↳ Contact Cleaner Spray est spécialement formulé pour nettoyer et dégraisser bougies, interrupteurs et autres composants électriques.
- ↳ C'est un pulvérisateur puissant qui garantit le nettoyage complet des éléments difficiles d'accès ou non démontables.
- ↳ Un additif spécial empêche la corrosion.



### NETTOYANT DIRT BIKE PRO ANTI-BOUE

**476542** 1L

- ↳ Nettoyant biodégradable hautement concentré, à action rapide, spécialement développé pour le nettoyage de vélomoteur, scooters et vélos.
- ↳ Cette formulation unique permet d'enlever rapidement boue, sable, goudron, graisse et autres saletés des surfaces synthétiques, métalliques ou peintes.
- ↳ Contient des inhibiteurs de corrosion qui protègent toutes les surfaces métalliques contre la corrosion.
- ↳ Utilisable sans risque sur l'aluminium, le chrome et les surfaces peintes.
- ↳ Inoffensif pour le caoutchouc ou les matériaux synthétiques.
- ↳ Laisse un film brillant.



### NETTOYANT AÉROSOL POUR FILTRE À AIR

**478979** 600mL

- ↳ Action cleaner est recommandé comme premier choix dans le monde entier par les équipes Team GP.
- ↳ C'est un dégraissant soluble dans l'eau, développé spécialement pour le nettoyage des filtres à air en mousse modernes.



### NETTOYANT AÉROSOL POUR FREIN

**478978** 500mL

- ↳ Nettoyant et dégraissant frein rapide pour toutes les parties du freinage, comme les maîtres cylindres, les étriers et les disques.
- ↳ Ne laisse aucun résidu sur les composants nettoyés.



## ENTRETIEN, NETTOYANT



## LUSTREUR AÉROSOL SILICONE SPÉCIAL PLASTIQUE

476546 500mL

- ↳ Silicon Spray restaure les couleurs et redonne de l'éclat à une grande variété de plastiques et de surfaces peintes et facilite en même temps les futurs nettoyages.
- ↳ Sa formulation hydrofuge assure une protection idéale pour les composants électriques contre l'humidité et l'entrée d'eau.



## NETTOYANT AÉROSOL INTÉRIEUR CASQUE SANITIZER

497361 500mL



## NETTOYANT SPRAY RS1 BIKE WASH PRO BIODÉGRADABLE

495341 1L

- ↳ RS1 Bike Wash Pro est un nettoyant biodégradable à action rapide.
- ↳ Des additifs spéciaux anti-corrosion assurent la protection de toutes les pièces métalliques.
- ↳ Sa formule hautement concentrée élimine efficacement la boue, le sable, le goudron, la graisse et toute autre saleté des surfaces en plastique, métalliques et traitées ou peintes.
- ↳ Le produit convient pour les motos, scooters et bicyclettes.
- ↳ N'abîme pas le caoutchouc et le plastique. Laisse un éclat éblouissant.



## ENTRETIEN, NETTOYANT



### NETTOYANT

|               |   |       |
|---------------|---|-------|
| <b>461815</b> | contact pour allumage et circuit électrique | 500mL |
| <b>461796</b> | efface rayure presto pour peinture          |       |
| <b>479589</b> | frein, aérosol                              | 600mL |



461815



461796



479589



### NETTOYANT

|               |                              |       |
|---------------|------------------------------|-------|
| <b>390402</b> | frein, aérosol, sans acétone | 600mL |
|---------------|------------------------------|-------|



### NETTOYANT 250ML

|               |                     |
|---------------|---------------------|
| <b>388540</b> | alu                 |
| <b>388535</b> | chromes             |
| <b>388516</b> | cire cuir           |
| <b>388527</b> | cuir                |
| <b>388554</b> | jantes              |
| <b>388501</b> | lustreur            |
| <b>477357</b> | rénovateur peinture |



388540



388535



388516



388527



388554



388501



477357

## ENTRETIEN, NETTOYANT

Sélection  
**CGN****GANT DE TRAVAIL****Jetable résistant aux produits chimiques**

|        |     |    |      |
|--------|-----|----|------|
| 497594 | T9  | M  | x100 |
| 497595 | T10 | L  | x100 |
| 497596 | T11 | XL | x100 |

**Jetable haut résistance aux produits chimiques**

|        |     |     |      |
|--------|-----|-----|------|
| 492405 | T9  | M   | x100 |
| 486821 | T10 | L   | x100 |
| 486823 | T11 | XL  | x100 |
| 486824 | T12 | XXL | x100 |

**Standard basic**

|        |     |     |    |
|--------|-----|-----|----|
| 482225 | T9  | L   | x2 |
| 482226 | T10 | XL  | x2 |
| 484822 | T11 | XXL | x2 |

**Standard résistant aux hydrocarbures**

|        |     |   |    |
|--------|-----|---|----|
| 482227 | T9  | M | x2 |
| 482228 | T10 | L | x2 |



Jetable résistant aux produits chimiques



Jetable haute résistance aux produits chimiques



Basic



Résistant aux hydrocarbures

**LOCTITE****SAVON NETTOYANT MAIN**

|        |    |      |
|--------|----|------|
| 390436 | 3L | 4.5L |
|--------|----|------|

**Putoline****SAVON NETTOYANT MAIN PARFUM CITRON**

|        |      |      |
|--------|------|------|
| 476556 | 4.5L | 4.5L |
|--------|------|------|

Sélection  
**CGN****BOBINE PAPIER ESSUIE MAINS**

|        |  |    |
|--------|--|----|
| 487813 | blanc 100% recyclé, rouleau de 300m    | x2 |
| 485116 | ouaté, rouleau de 300m, made in France | x2 |



487813



485116

Sélection  
**CGN****BOBINE PAPIER ESSUIE MAINS**

|        |   |
|--------|---|
| 486951 | fontaine biologique Bio-Circle, complète avec 80L de liquide biologique |
| 486952 | liquide biologique Bio-Circle avec micro-organismes pour fontaine       |











486951



486952

## FOURCHE

### FOURCHE | AMORTISSEUR

|               |   |   |
|---------------|---|---|
| <b>482144</b> | mord, mordache pour étau (blocage fourche/piston) mâchoires pour Ø28-70mm   |  |
| <b>458736</b> | blac axe pour fourche hydraulique 600mm                                     |  |
| <b>458735</b> | comprime ressort amortisseur  |  |
| <b>489833</b> | outillage réglage amortisseur   |  |
| <b>477186</b> | pompe pour amortisseur et fourche suspension alu/noir avec manomètre 20Bars |  |
| <b>440656</b> | pompe pour amortisseur et fourche suspension argent avec manomètre 20Bars   |  |
| <b>494522</b> | pompe pour amortisseur CESIAS tout alu avec manomètre 20.6Bars/300PSI       |  |
| <b>494355</b> | clé à ergot pour démontage écrou direction                                  |  |



482144



458736



458735



489833



477186



440656



494522



494355

## ROUE



### OUTIL DE DÉMONTAGE AXE DE ROUE AVANT

|               |                     |
|---------------|---------------------|
| <b>494345</b> | 12-14-17-19-22-24mm |
| <b>494346</b> | 17-19-22-24mm       |



494345



494346









### CLÉ À RAYON

|               |                           |
|---------------|---------------------------|
| <b>483332</b> | 4.3-4.8-5.3-5.6-6.0-6.3mm |
|---------------|---------------------------|



## FREIN

## FREIN

|        |   |  |
|--------|---|--|
| 484629 | clapet anti-retour pour purge frein, circuit hydraulique            |  |
| 484628 | kit purgeur pour circuit de frein                                   |  |
| 441893 | kit purgeur pneumatique pour circuit de frein                       |  |
| 477411 | outil écarteur plaquette de frein                                   |  |
| 476159 | outil écarteur plaquettes de frein, repousse piston étrier de frein |  |
| 496356 | démonte piston étrier de frein                                      |  |



484629

484628

441893

477411

476159

496356

## BOUGIE



## CLÉ À BOUGIE

|        |  |          |
|--------|--|----------|
| 465274 | 2 temps  | 21mm     |
| 477259 | 2 temps renforcée                                | 21mm     |
| 481364 | 4 temps (HONDA 4 temps), avec blocage caoutchouc | 14-110mm |
| 479048 | 4 temps  | 16-80mm  |
| 479582 | 4 temps, avec blocage caoutchouc                 | 16-100mm |
| 483864 | 4 temps  | 18-100mm |



465274

477259

481364

479048

479582

483864



## BOUGIE

|      |  |
|------|--|
| 7587 | brosse à bougie                        |
| 7593 | clé à bougie 2 temps tournevis intégré |



7587



7593



ALLUMAGE



ARRACHE VOLANT

|        |  |        |
|--------|--|--------|
| 449961 | AM6   DERBI  | 19x100 |
| 486878 | CPI pas à gauche                                   | 18x100 |
| 479585 | MVT   DOPPLER   MINARELLI   MORINI   APRILIA 2 vis |        |
| 479586 | MINARELLI   MORINI   SUZUKI   SOLEX 3 vis          |        |
| 496697 | YAMAHA 125 à 400CC 6vis                            |        |
| 495189 | MBK CYCLO rotor et variateur 139 QMB               | 24x10  |



479585



479586



ARRACHE VOLANT

|        |   |               |
|--------|---|---------------|
| 269979 | AM6   DERBI montage DUCATI                  | 19x100        |
| 7569   | MBK cyclo 139 QMB                           | 24x100-26x100 |
| 7566   | PEUGEOT 103   102   101   105   104         | 20x100        |
| 269964 | DERBI SENDA-R   MALAGUTI                    | 22x150-26x150 |
| 367883 | DERBI   GPR   SENDA                         | 27x125-20x100 |
| 482373 | MINARELLI   MORINI   SUZUKI 3 vis           |               |
| 251330 | PIAGGIO   LUDIX BLASTER                     | 26x100        |
| 7571   | PEUGEOT SCOOTER   CYCLO MBK 51 électronique |               |
| 490223 | GENERIC                                     | 19x125        |
| 496920 | BOOSTER   EVOLIS   SV50   SC50 pas à gauche | 27x100        |



482373



269979

269964

490223



ARRACHE VOLANT COFFRET 10 PIÈCES

477386 PEUGEOT | HONDA | MINARELLI | DUCATI









INFO + :

|            |         |                      |
|------------|---------|----------------------|
| Attaches : | M14x1.5 | M22x1.5              |
|            | M16x1.5 | M25x1.5              |
|            | M18x1.5 | M26x1                |
|            | M19x1   | M27x1.5 pas à gauche |
|            | M20x1   | M28x1                |
|            | M22x1   | M28x1.5              |



## ALLUMAGE

## ARRACHE VOLANT

|        |   |        |   |
|--------|---|--------|---|
| 7568   | BOOSTER   EVOLIS   SV50   SC50            | 27x100 |  |
| 461573 | BOOSTER   NITRO CATALYSE 2004-> 3 vis     |        |  |
| 449963 | BOSCH   DUCATI   MOTOPLAT                 | 22x150 |  |
| 449964 | MBK CYCLO   SCOOTER PEUGEOT   HONDA       | 24x100 |  |
| 7574   | MOTOPLAT rotor externe                    | 26x150 |  |
| 7575   | MVT rotor externe, MOTOPLAT rotor interne |        |  |
| 7573   | CIAO PX                                   | 17x100 |  |
| 449962 | PEUGEOT 103   102   101   105   104       | 20x100 |  |
| 496357 | SOLEX 3 vis                               |        |  |



7568



461573



449963



449964



7574



7575



7573



449962



496357

## TUN'R

## CLÉ SANGLE

|        |   |
|--------|---|
| 449781 | serre volant, cloche, tambour, filtre à huile |
| 489989 | serre volant, cloche, tambour                 |



449781



489989

## DÉMONTE EMBRAYAGE



280794



478904



168553



467828



MINARELLI | PEUGEOT | KYMCO  
| MALAGUTI



MINARELLI | PEUGEOT | KYMCO  
| MALAGUTI



MINARELLI | PEUGEOT | KYMCO  
| MALAGUTI



MINARELLI | PEUGEOT | KYMCO  
| MALAGUTI

## DÉMONTAGE EMBRAYAGE



167322



MINARELLI | PEUGEOT |  
KYMCO | MALAGUTI



467826



MINARELLI | PEUGEOT |  
KYMCO | MALAGUTI (P | E



168549



PIAGGIO pour écrou 34mm



280794



MINARELLI | PEUGEOT |  
KYMCO | MALAGUTI



467825



presse ressort, Ø embryage maxi  
125mm



458734



PEUGEOT 2003->



481844



MAXI SCOOTER PIAGGIO |  
VESPA 125 | 250 | 300



483334



PIAGGIO pour écrou 34mm



497081



universel à ergot,  
entraxe max 140mm



497082



universel à ergot plat pour noix

## ROULEMENT, EMBIELLAGE



### OUTIL DE DÉMONTAGE

- 461577 arrache roulement embiellage
- 461576 demi carter moteur universel
- 478723 arrache roulement universel
- 491064 montage joint SPI pour PIAGGIO 50CC 2 temps côté allumage



461577



461576



491064



478723

## MÉTROLOGIE

## PIGE DE CALAGE 14X125

477380 micrométrique 7581 micrométrique 7579 

477380



7581



7579



## PEIGNE

478334 jauge, filon de filetage



## DISQUE GRADUÉ

495861 pour mesure diagramme, réglage arbre à cane Ø220mm



## CÂLES

483803 12 câles épaisseur 0.01 mm à 1.00mm, pour réglage culbuteur



## BALANCE DE PRÉCISION

487061 précision 0.1g, jusqu'à 500g



## DOUILLE CLÉ DE SERRAGE ANGULAIRE

494356 carré 1/2"



PISTON

**TUN'R** BLOQUE PISTON



**468226**

M10X100

tête hexagonale, moteur 4 temps



**480772**

M12X125

tête hexagonale pour clé 17mm



**468227**

M14X125

tête hexagonale



**7582**

M14X125

SOUPAPE



SOUPAPE

- 481373** outil de démontage, culasse 4 temps, 5 adaptateurs
- 481370** outil de réglage culbuteur, moteur 4 temps, pour écrou 8mm
- 481372** outil de rodage, moteur 4 temps, 4 ventouses



PÂTE À RODER 34B

**486321** 85g

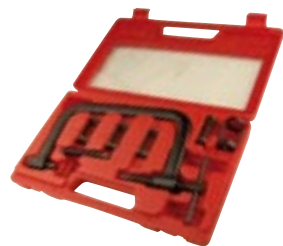

481373



481370



481372



FILTRE À HUILE



DÉMONTE FILTRE À HUILE

- 481371** Ø61-97mm
- 481845** Ø65-67mm
- 481846** Ø68mm 14 pans
- 481847** Ø74-76mm
- 481848** Ø76mm 14 pans
- 482145** 125 à 300CC
- 495075** Ø76mm spécial PIAGGIO



481371



481846



482145



DÉMONTE FILTRE À HUILE RUBAN

- 494789** Ø60-105mm



## VARIATEUR



209831

bloque variateur 50 PIAGGIO



481361

bloque variateur OVETTO | NEOS  
| BOOSTER 4 temps 50CC

494358

CPI | GENERIC 6V | KYMCO |  
KEEWAY 50 CC

491996

MINARELLI 2 temps horizontal



494357

SYM 50CC 4 temps FIDDLE |  
SYMPHONY | PEUGEOT

491995

YAMAHA 500-530 TMAX



482374

bloque variateur PEUGEOT 50 |  
100CC 2 temps

## CHAÎNE ET COURROIE

## CHAÎNE ET COURROIE

- 481843** dérivation chaîne, pour chaîne 415 420 428 520
- 481366** poinçon dérivation chaîne (pour 481843)
- 465275** dérivation chaîne articulée 415 | 420 | 428 | 520 | 525 | 530 | 532
- 493939** réglage tension courroie YAMAHA 530 T-MAX



481843



481366



465275



493939

## DÉRIVE CHAÎNE ATELIER

- 279297** pour cyclo et moto
- 497534** cyclo, moto type BRAMPTON



279297

## CYLINDRE



### CYLINDRE

**472434** rodoir de cylindre Ø32-89mm

**483769** pierre rodoir de cylindre x3



472434



483769



### COMPRISE SEGMENTS

**484626** collier de serrage, piston Ø40-80mm



## CARBURATEUR



### COFFRET ALESDIR GICLEUR

**484191** 21 alesoirs Ø0.35mm à Ø1.35 par 5/100eme



### ALESDIR GICLEUR (X1)

**484489** Ø0.35mm

**484490** Ø0.40mm

**484491** Ø0.45mm

**484492** Ø0.50mm

**484805** Ø0.55mm

**484806** Ø0.60mm

**484807** Ø0.65mm

**484808** Ø0.70mm

**484809** Ø0.75mm

**484810** Ø0.80mm

**484811** Ø0.85mm

**484812** Ø0.90mm

**484813** Ø0.95mm

**484814** Ø1.00mm

**484815** Ø1.05mm

**484816** Ø1.10mm

**484817** Ø1.15mm

**484818** Ø1.20mm

**484819** Ø1.25mm

**484820** Ø1.30mm

**484821** Ø1.35mm



## CARBURATEUR



## OUTIL NETTOYAGE GICLEUR

484972 0.45mm à 1.50mm



## TOURNEVIS

481665 extra long à tête plate spécial accès difficile carburateur

481666 réglage carburateur GURTNER, carburateur PEUGEOT accès difficile

484627 tournevis plat renvoi d'angle, longueur 430mm



481665



481666



484627

## ELECTRICITÉ



## FUSIBLE (X50)

478303 plat enfichable GM assortie 7.5A-10A-15A-20A

478304 verre assortie 7.5A-10 A-15A-20A, 3cm



478303



478304



## FUSIBLE

|        |                   |                                 |      |
|--------|-------------------|---------------------------------|------|
| 481321 | 5A                | verre                           | x1   |
| 458158 | 7.5A              | plat enfichable                 | x10  |
| 378037 | 10A               | verre 3cm                       | x10  |
| 487478 | 15A               | verre                           | x10  |
| 487477 | 20A               | verre                           | x10  |
| 378026 | 10A               | plat enfichable                 | x10  |
| 481808 | 3-5-7.5-10-15-20A | plat enfichable                 | x6   |
| 486014 | coffret           | plat miniature, classique, rond | x150 |



481321

458158



378037



487478



487477



378026



481808



486014



## ELECTRICITÉ

Sélection  
**CGN**

### FIL ÉLECTRIQUE

|        |         |      |       |
|--------|---------|------|-------|
| 483473 | 7/10eme | 1.9m | noir  |
| 496254 | 0.75mm  | 25m  | blanc |
| 496249 | 0.75mm  | 25m  | bleu  |
| 496252 | 0.75mm  | 25m  | brun  |
| 496253 | 0.75mm  | 25m  | gris  |
| 496250 | 0.75mm  | 25m  | jaune |
| 496247 | 0.75mm  | 25m  | noir  |
| 496248 | 0.75mm  | 25m  | rouge |
| 496251 | 0.75mm  | 25m  | vert  |
| 496255 | 1.00m   | 25m  | jaune |
| 496256 | 1.00m   | 25m  | vert  |
| 496257 | 1.50mm  | 25m  | noir  |
| 496258 | 1.50mm  | 25m  | rouge |
| 496259 | 2.50mm  | 25m  | noir  |
| 496260 | 2.50mm  | 25m  | rouge |



483473



496254



496249



496252



496253



496250



496248



496251

## COSSE, CONNECTEUR, GAINÉ ÉLECTRIQUE



441869

**FÖRCH**

cosse femelle gaine 4.8mm  
qualité atelier x100



441870

**FÖRCH**

cosse femelle gaine 6.3mm  
qualité atelier x100



483062

Sélection  
**CGN**

cosse mâle plate 6.3mm qualité  
atelier x100



484985

Sélection  
**CGN**

cosse cylindrique femelle 3.5mm  
x25



484984

Sélection  
**CGN**

cosse cylindrique mâle 3.5mm  
x25



484989

Sélection  
**CGN**

cosse femelle laiton largeur 3mm  
contacteur stop x50



484992

Sélection  
**CGN**

cosse mâle et femelle, coffret de  
120 panaches



484987

Sélection  
**CGN**

connecteur plastique mâle et  
femelle et cosse 2 fiches

## ELECTRICITÉ

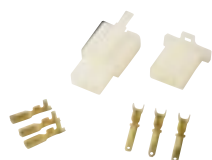

484988

Sélection  
**CGN**connecteur plastique mâle et  
femelle et cosse 3 fiches

484990

Sélection  
**CGN**connecteur plastique mâle et  
femelle plus cosse 4 fiches

484991

Sélection  
**CGN**connecteur plastique mâle et  
femelle et cosse 6 fiches

484775

Sélection  
**CGN**gaine thermorétractable de  
2.4mm à 1.2mm, rouleau  
200mm

484776

Sélection  
**CGN**gaine thermorétractable de  
3.2mm à 1.6mm, rouleau de  
20mm

484777

Sélection  
**CGN**gaine thermorétractable de  
4.8mm à 2.4mm, rouleau de  
200mm

484986

Sélection  
**CGN**gaine thermorétractable, coffret  
de 60 manchons de 40mm  
panachés

## OUTILLAGE

Sélection  
**CGN**

## COFFRET RÉPARATION FILETAGE

|        | Coffret taraud/filière/Helicoil | Recharge Helicoil x10 |
|--------|---------------------------------|-----------------------|
| 494149 | M5X0.8 avec 20 pièces           | 494156                |
| 494150 | M6X1.0 avec 20 pièces           | 494157                |
| 495813 | M7X1.0 avec 20 pièces           | 495814                |
| 494152 | M8X1.25 avec 20 pièces          | 494159                |
| 494153 | M10x1.0 avec 15 pièces          | 494160                |
| 494154 | M12X1.25 avec 10 pièces         | 494161                |
| 494155 | M14X1.25 avec 5 pièces          | 494162                |

Sélection  
**CGN**

## EXTRACTEUR DE GOUJON

495152 coffret, pour vis cassée et abimée



## OUTILLAGE



490733



entonnoir rectangulaire avec filtre extra fin, capacité 4 litres



487247



entonnoir, kit de 4



480773



réservoir auxiliaire d'atelier avec durite et robinet (nourrice)



490734



jerrican hydrocarbures, essence norme UN 20 litre



484622



récupérateur de fluide 2.7L



489973



pompe à vidange, syphonage par aspiration 12V



490736



enrouleur air pneumatique 9m, abs renforcé, Ø intérieur 8mm, pression max 12Bar



491106



soufflette progressive et raccord 4m spirale



461572



pince à clips 4 en 1 pour circlips intérieurs et extérieurs



484625



pince à clips avec becs à 90° pour circlips intérieurs profonds



452089



pince à clips 3 en 1



490300



tournevis, doigt magnétique flexible



480234



tournevis à percussion, frapper, avec 6 embouts



478730



maillet plastique anti rebond 1.15kg



449901



Démontage, remontage ressort universel



472442



outil chasse joint torique

## OUTILLAGE



480780

Sélection  
**CGN**

coffret de douilles chrome,  
vanadium 3/6 8 pans de  
6-22mm x24



480779

Sélection  
**CGN**

coffret de douilles chrome,  
vanadium 1/4 de 4-13mm



480781

Sélection  
**CGN**

coffret de douilles chrome,  
vanadium 1/4 6 pans de  
4-14mm x19



480800

Sélection  
**CGN**

clé dynamométrique, coffret  
outillage, clé allen torx de  
2-24Nm



452126

Sélection  
**CGN**

coffret embouts outillage,  
100 pièces



493138

Sélection  
**CGN**

clé allen courte, jeu de  
9, 1.5-2-2.25-3-4-5-6-8-10mm



484216

Sélection  
**CGN**

coffret de forets HSS laminés  
Ø1-10mm 1/2mm



484548

Sélection  
**CGN**

disque meuleuse, lapidaire  
à tronçonner acier et inox  
Ø115mm



484549

Sélection  
**CGN**

disque meuleuse, lapidaire  
à tronçonner acier et inox  
Ø125mm

LEVAGE ET TRANSPORT



SUPPORT MOTO PLIABLE POUR STAND, MAINTENANCE, CHARGE MAX 250KG

- 483122 orange
- 483124 rouge
- 483125 vert



483122



483124



483125



SUPPORT UNIVERSEL

- 486794 hauteur 290mm au repos et 370mm levé
- 486978 réglable sur 4 hauteurs 400-415-420-437mm



486794



486978



SANGLE

- |        |  |              |
|--------|--|--------------|
| 485387 | à boucle ZAMAC JOUBERT                 | 25mmx5.0m    |
| 485385 | à cliquet avec crochet JOUBERT "S"     | 25mmx5.0m    |
| 485386 | à cliquet EASY JOUBERT                 | 25mmx5.0m    |
| 485384 | à cliquet JOUBERT                      | 25mmx3.5m    |
| 485388 | arrimage moto avec crochet JOUBERT "S" | 25mmx2.0m x2 |



485387



485385



485386



485384



485388



## VIS 6 PANS CREUX TC BTR

|        |       |      |
|--------|-------|------|
| 208414 | M4x20 | x100 |
| 208452 | M4x25 | x100 |
| 208448 | M5x20 | x100 |
| 208433 | M5x25 | x100 |
| 208429 | M5x30 | x100 |
| 162560 | M6x16 | x100 |
| 162574 | M6x20 | x100 |
| 162589 | M6x25 | x100 |
| 162593 | M6x30 | x100 |
| 162608 | M6x40 | x100 |
| 162612 | M8x20 | x100 |
| 162631 | M8x30 | x100 |
| 162646 | M8x40 | x100 |
| 178709 | M8x60 | x50  |



## BOULON 6 PANS (X100)

|        |       |
|--------|-------|
| 8912   | M5x10 |
| 263177 | M5x25 |
| 8922   | M6x20 |
| 263249 | M6x40 |
| 8929   | M7x60 |



## RONDELLE ACIER (X100)

|        |       |
|--------|-------|
| 8817   | 5x12  |
| 8823   | 5x20  |
| 8818   | 6x12  |
| 263488 | 6x18  |
| 8819   | 7x14  |
| 8821   | 10x20 |



## RONDELLE ÉVENTAIL (X100)

|      |      |
|------|------|
| 8824 | Ø4mm |
| 8826 | Ø5mm |
| 8827 | Ø6mm |
| 8830 | Ø8mm |



## RONDELLE NYLON (X1)

|      |                 |
|------|-----------------|
| 8910 | pour vis carter |
|------|-----------------|



## ÉCROU 6 PANS

|        |         |      |
|--------|---------|------|
| 8933   | M4x0.70 | x100 |
| 8934   | M5x0.80 | x100 |
| 8935   | M6x1    | x100 |
| 8936   | M7x1    | x100 |
| 263454 | M8x1.25 | x50  |
| 8847   | M9.5x1  | x100 |
| 8849   | M10x1   | x10  |





## ECROU DE ROUE

|               |                     |  |          |
|---------------|---------------------|--|----------|
| <b>481458</b> | avant bague nylon   | BOOSTER   OVET TO   ROCKET                         | M10x1.25 |
| <b>481459</b> | avant bague nylon   | TREKKER   VIVA CITY   LUDIX                        | M12x1.25 |
| <b>481461</b> | avant bague nylon   | TYPHOON  | M12x1.25 |
| <b>481460</b> | arrière bague nylon | SCOOTER CHINOIS                                    | M16x1.50 |
| <b>482370</b> | arrière             | BOOSTER   OVETTO   ROCKET   TKR   VIVACITY   LUDIX | M14x1.50 |
| <b>481457</b> | arrière             | BOOSTER   OVETTO   ROCKET   TKR   VIVACITY   LUDIX | M14x1.50 |
| <b>8907</b>   | avant               | cyclo 103   51                                     | M10x1.00 |
| <b>8906</b>   | avant               | cyclo 103   51 rayon                               | M11x1.00 |
| <b>8908</b>   | avant               | cyclo 103   51                                     | M12x1.00 |



## EMBOUT DE GAINÉ (X100)

|               |          |
|---------------|----------|
| <b>170822</b> | 6.1x12mm |
| <b>8812</b>   | 6.8x12mm |



## BUTÉE DE GAINÉ (X100)

|               |                       |      |
|---------------|-----------------------|------|
| <b>172199</b> | Ø7x11mm frein avant   | x100 |
| <b>8808</b>   | Ø8x4.8mm              | x100 |
| <b>172366</b> | Ø8x13mm frein arrière | x100 |
| <b>495812</b> | Ø9x14mm               | x25  |



## SERRE-CÂBLES X100

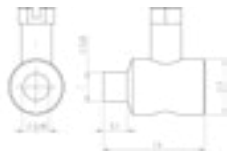

**8803**

2 pièces moto Ø8 | 5mm longueur 13mm perçage 3.5mm



**491076**

2 pièces moto Ø9mm longueur 10mm perçage 3.5mm

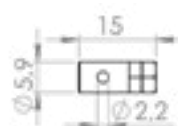

**8835**

frein avant et poignée cyclo

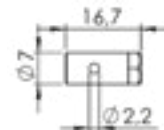

**8805**

frein tambour

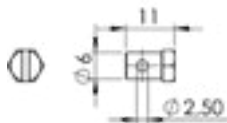

**8836**

gaz PEUGEOT Ø6mm longueur 7mm perçage 2.5mm



## SERRE-CÂBLES X100

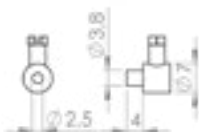

**172332**

décompresseur cyclo 103, frein arrière MBK

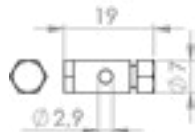

**8833**

frein cyclo Ø6.8mm longueur 13.5mm perçage 2.6mm

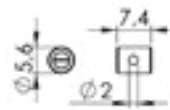

**8806**

MAGURA gaz poignée Ø5.5mm longueur 7mm perçage 2mm tirage rapide

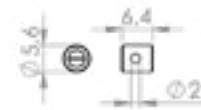

**478564**

MAGURA gaz poignée Ø5.5mm longueur 6mm perçage 1.8mm tirage rapide



## SERRE-CÂBLES X25

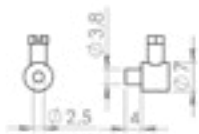

**486933**

décompresseur 103 frein arrière  
MBK

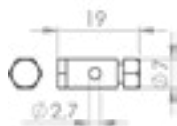

**486935**

cyclo Ø6.8mm longueur 13.5mm  
perçage 2.6mm

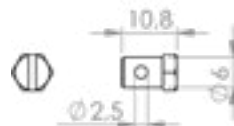

**486936**

gaz PEUGEOT Ø6mm longueur  
7mm perçage 2.5mm

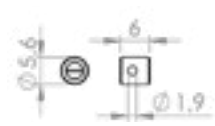

**486934**

Magura gaz poignée Ø5.5mm  
longueur 6mm perçage 1.8mm



## SERRE-CÂBLES X1



**3419**

frein cyclo CIAO PX

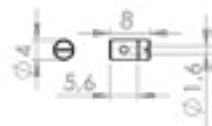

**252738**

gaz poignée Ø1.6mm

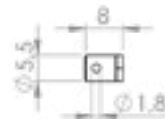

**252742**

gaz poignée Ø2.2mm

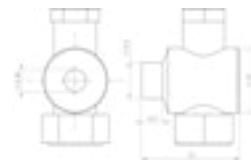

**494104**

moto Ø10mm longueur 15mm  
perçage 5.5mm 3 pièces



## SERRE TRINGLE (X1)

**8904**

6x13mm



## VIS CREUSE POIGNÉE (X1)

**8885**

M6x100mm pour gaine 6mm

**8886**

M5x0.80mm

**482401**

M6x100mm fendue pour gaine 6mm

**8887**

M6x100mm non fendue pour gaine 7mm



8885



8886



482401



8887



## VIS CREUSE POIGNÉE (X1)

**496377**

M6x100mm fendue pour gaine 5mm embrayage, frein

**493947**

M7x100mm fendue pour gaine 8mm embrayage

**496378**

M8x125mm fendue pour gaine 8mm embrayage







## VIS CARTER, CAPOTAGE CYCLO

|        |            |      |
|--------|------------|------|
| 172203 | MBK        | x1   |
| 497630 | 103 5X12mm | x1   |
| 179485 | 103 5x12mm | x100 |



172203



179485



## VIS EMBRAYAGE CYCLO

|      |               |    |
|------|---------------|----|
| 4193 | MBK 51 4x14mm | x1 |
|------|---------------|----|



## VIS ET AGRAFE POUR CARROSSERIE (X20)

|        |                     |
|--------|---------------------|
| 478430 | M11x16x4.5x0.6mm    |
| 478431 | M12 .5x20x4.5x0.6mm |



## VIS INOX DE COUVERCLE, CAPOT MAÎTRE CYLINDRE DE FREIN (X1)

|        |         |
|--------|---------|
| 483092 | M4x12mm |
|--------|---------|



## VIS QUART DE TOUR CARROSSERIE TYPEE DZUS (X10)

|        |      |      |
|--------|------|------|
| 494528 | M6mm | alu  |
| 494527 | M6mm | noir |



**455400**

BOOSTER NG acier chrome

**455395**BOOSTER SPIRIT | BW'S ->2003  
acier noir**455396**BOOSTER SPIRIT | BW'S ->2003  
acier chrome**319507**BOOSTER SPIRIT | BW'S >2003  
alu bleu**319689**

BUXY | ZENIT | SPEEDAKE bleu

**455394**NITRO | AEROX ->2013 acier  
chrome**455393**

NITRO | AEROX -&gt;2013 acier noir

**319579**

NITRO | AEROX -&gt;2013 alu or

**319564**

NITRO | AEROX -&gt;2013 alu rouge

**480775**

OVETTO | NEOS acier chrome

**455398**

SPEEDFIGHT acier chrome

**455397**

SPEEDFIGHT acier noir

**480774**SQUAB | TREKKER | TKR acier  
chrome**480776**

TYPHOON acier chrome



**455361**

BOOSTER | BW' S | OVETTO  
| NITRO acier chrome  
M6x25/40/45 x12



**455360**

BOOSTER | BW' S | OVETTO |  
NITRO acier noir M6X25/40/45  
x12



**243942**

BOOSTER | BW' S | OVETTO |  
NITRO alu bleu M6X25/40/45  
x12



**250883**

BOOSTER | BW' S | OVETTO |  
NITRO alu chrome M6X25/40/45  
x12



**243923**

BOOSTER | BW' S | OVETTO |  
NITRO alu rouge M6X25/40/45  
x12



**455363**

TREKKER | BUX Y | TKR |  
VIVACITY | SPEEDFIGHT acier  
chrome x11



**455362**

TREKKER | BUX Y | TKR |  
VIVACITY | SPEEDFIGHT acier  
noir x11



**244001**

TREKKER | BUX Y | TKR |  
VIVACITY | SPEEDFIGHT alu bleu  
x11



**250898**

TREKKER | BUX Y | TKR |  
VIVACITY | SPEEDFIGHT alu  
chrome x11



**460015**

BOOSTER | BW' S | CMC  
convoque acier bleu  
M6X25/40/45 x12



**460016**

BOOSTER | BW' S | CMC  
convoque acier chrome  
M6X25/40/45 x12



**460017**

BOOSTER | BW' S | CMC  
convoque acier or M6X25/40/45  
x12



**460018**

BOOSTER | BW' S | CMC  
convoque acier rouge  
M6X25/40/45 x12



## VIS ET ÉCROU DE CARENAGE (X8)

**479281** encastrable





### IMPRIMANTE PLAQUE IMMATRICULATION

**489670** avec logiciel 123 plaque licence définitive

**489668** laser plaque



### ROULEAU D'ENCOLLAGE, LAMINEUSE

**489671** pour assemblage des plaques d'immatriculation

Rivet

**455310** rivet blanc 4x16mm x100

**450845** cache rivet blanc x100

**493989** pince à rivet



489671



493989



455310



450845



## BANDE PLAQUE D'IMMATRICULATION BLANCHE 210X130MM SIV (X10)



|        |                            |
|--------|----------------------------|
| 490901 | 01 - AIN                   |
| 490902 | 02 - AISNE                 |
| 490903 | 03 - ALLIER                |
| 490904 | 04 - ALPES HAUTES PROVENCE |
| 490905 | 05 - HAUTES ALPES          |
| 490906 | 06 - ALPES MARITIMES       |
| 490907 | 07 - ARDECHE               |
| 490908 | 08 - ARDENNES              |
| 490909 | 09 - ARIEGES               |
| 490910 | 10 - AUBE                  |
| 490911 | 11 - AUDE                  |
| 490912 | 12 - AVEYRON               |
| 490913 | 13 - BOUCHES DU RHONE      |
| 490914 | 14 - CALVADOS              |
| 490915 | 15 - CANTAL                |
| 490916 | 16 - CHARENTE              |
| 490917 | 17 - CHARENTE MARITIME     |
| 490918 | 18 - CHER                  |
| 490919 | 19 - CORREZE               |
| 491001 | 2A- CORSE DU SUD           |
| 491002 | 2B- HAUTE CORSE            |
| 490921 | 21- COTE D'OR              |
| 490922 | 22- COTES D'ARMOR          |
| 490923 | 23- CREUSE                 |
| 490924 | 24- DORDOGNE               |
| 490925 | 25- DOUBS                  |
| 490926 | 26- DROME                  |
| 490927 | 27- EURE                   |
| 490928 | 28- EURE ET LOIRE          |
| 490929 | 29- FINISTERE              |
| 490930 | 30- GARD                   |
| 490931 | 31- HAUTE GARONNE          |
| 490932 | 32- GERS                   |
| 490933 | 33- GIRONDE                |
| 490934 | 34- HERAULT                |
| 490935 | 35- ILE ET VILAINE         |
| 490936 | 36- INDRE                  |
| 490937 | 37- INDRE ET LOIRE         |
| 490938 | 38- ISERE                  |
| 490939 | 39- JURA                   |
| 490940 | 40- LANDES                 |
| 490941 | 41- LOIR ET CHER           |
| 490942 | 42- LOIRE                  |
| 490943 | 43- HAUTE LOIRE            |
| 490944 | 44- LOIRE ATLANTIQUE       |
| 490945 | 45- LOIRET                 |
| 490946 | 46- LOT                    |
| 490947 | 47- LOT ET GARONNE         |
| 490948 | 48- LOZERE                 |

|        |                           |
|--------|---------------------------|
| 490949 | 49- MAINE ET LOIRE        |
| 490950 | 50- MANCHE                |
| 490951 | 51- MARNE                 |
| 490952 | 52- HAUTE MARNE           |
| 490953 | 53- MAYENNE               |
| 490954 | 54- MEURTHE ET MOSELLE    |
| 490955 | 55- MEUSE                 |
| 490956 | 56- MORBIHAN              |
| 490957 | 57- MOSELLE               |
| 490958 | 58- NIEVRE                |
| 490959 | 59- NORD                  |
| 490960 | 60- OISE                  |
| 490961 | 61- ORNE                  |
| 490962 | 62- PAS DE CALAIS         |
| 490963 | 63- PUY DE DOME           |
| 490964 | 64- PYRENEES ATLANTIQUES  |
| 490965 | 65- HAUTES PYRENEES       |
| 490966 | 66- PYRENEES ORIENTALES   |
| 490967 | 67- BAS RHIN              |
| 490968 | 68- HAUT RHIN             |
| 490969 | 69- RHONE                 |
| 490970 | 70- HAUTE SAONE           |
| 490971 | 71- SAONE ET LOIRE        |
| 490972 | 72- SARTHE                |
| 490973 | 73- SAVOIE                |
| 490974 | 74- HAUTE SAVOIE          |
| 490975 | 75- PARIS                 |
| 490976 | 76- SEINE MARITIME        |
| 490977 | 77- SEINE ET MARNE        |
| 490978 | 78- YVELINES              |
| 490979 | 79- DEUX SEVRES           |
| 490980 | 80- SOMME                 |
| 490981 | 81- TARN                  |
| 490982 | 82- TARN ET GARONNE       |
| 490983 | 83- VAR                   |
| 490984 | 84- VAUCLUSE              |
| 490985 | 85- VENDEE                |
| 490986 | 86- VIENNE                |
| 490987 | 87- HAUTE VIENNE          |
| 490988 | 88- VOSGES                |
| 490989 | 89- YONNE                 |
| 490990 | 90- TERRITOIRE DE BELFORT |
| 490991 | 91- ESSONNE               |
| 490992 | 92- HAUTS DE SEINE        |
| 490993 | 93- SEINE SAINT DENIS     |
| 490994 | 94- VAL DE MARNE          |
| 490995 | 95- VAL D'OISE            |
| 490996 | 971- GUADELOUPE           |
| 490997 | 972- MARTINIQUE           |
| 490998 | 973- GUYANE               |
| 490999 | 974- LA REUNION           |
| 491000 | 976- MAYOTTE              |

## IMMATRICULATION / NUMBER PLATES

**PLAQUE D'IMMATRICULATION PERSONNALISÉE  
BLANCHE 210X145MM SIV (X50)**
**450867** disponible uniquement sur commande

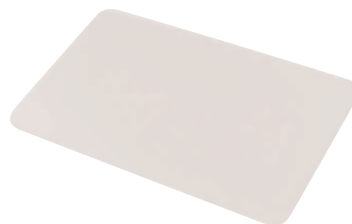
**PLAQUE D'IMMATRICULATION PERSONNALISÉE  
PVC 210X130MM SIV (X10)**
**450865** disponible uniquement sur commande

**BANDE PLAQUE IMMATRICULATION DÉPARTEMENT  
PPI BLANCHE 210X145MM SIV (X10)**
**468810** disponible uniquement sur commande

**BANDE PLAQUE IMMATRICULATION AVEC  
EUROLOGO PPI BLANCHE 210X130MM SIV (X10)**
**475575**

**LETTRE HAUTEUR 45MM NOIRE (X50)**

|               |   |
|---------------|---|
| <b>320647</b> | A |
| <b>322237</b> | B |
| <b>322241</b> | C |
| <b>322256</b> | D |
| <b>322267</b> | E |
| <b>322275</b> | F |
| <b>322280</b> | G |
| <b>322294</b> | H |
| <b>322313</b> | J |
| <b>322328</b> | K |
| <b>322332</b> | L |
| <b>322347</b> | M |
| <b>322351</b> | N |



|               |   |
|---------------|---|
| <b>322377</b> | P |
| <b>322385</b> | Q |
| <b>322390</b> | R |
| <b>322404</b> | S |
| <b>322419</b> | T |
| <b>322423</b> | U |
| <b>322438</b> | V |
| <b>322442</b> | W |
| <b>322457</b> | X |
| <b>322461</b> | Y |
| <b>322476</b> | Z |



## NUMÉRO HAUTEUR 45MM NOIRE (X50)

|        |   |
|--------|---|
| 320655 | 0 |
| 322487 | 1 |
| 322495 | 2 |
| 322500 | 3 |
| 322514 | 4 |
| 322529 | 5 |
| 322533 | 6 |
| 322548 | 7 |
| 322552 | 8 |
| 322567 | 9 |

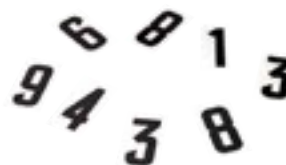

## POCHETTE PORTE CARTE GRISE PERSONNALISABLE (X100)

489152 disponible uniquement sur commande



## TIFLEX

### PLAQUE D'IMMATRICULATION BLANCHE AVEC EUROLOGO PRÉPERCÉE (X10)

|        |                  |         |
|--------|------------------|---------|
| 475576 | moto             | 210x130 |
| 497563 | cyclo et scooter | 210x140 |



## TIFLEX

### PLAQUE D'IMMATRICULATION BLANCHE HYBRIDE 210X130MM SIV RÉALISÉE

|        |                                     |         |
|--------|-------------------------------------|---------|
| 493827 | pour cyclo ancienne immatriculation | 210x130 |
|--------|-------------------------------------|---------|



## TIFLEX

### PLAQUE D'IMMATRICULATION BLANCHE PRÉPERCÉE 210X140MM SIV (X50)

468820 disponible uniquement sur commande



TIFLEX

**PLAQUE D'IMMATRICULATION PRÉPERCÉE  
BLANCHE 210X130MM SIV (X10)**

|        |                             |        |                           |
|--------|-----------------------------|--------|---------------------------|
| 491501 | 01 - AIN                    | 491549 | 49- MAINE ET LOIRE        |
| 491502 | 02 - AISNE                  | 491550 | 50- MANCHE                |
| 491503 | 03 - ALLIER                 | 491551 | 51- MARNE                 |
| 491504 | 04 - ALPES HAUTES PROUVENCE | 491552 | 52- HAUTE MARNE           |
| 491505 | 05 - HAUTES ALPES           | 491553 | 53- MAYENNE               |
| 491506 | 06 - ALPES MARITIMES        | 491554 | 54- MEURTHE ET MOSELLE    |
| 491507 | 07 - ARDECHE                | 491555 | 55- MEUSE                 |
| 491508 | 08 - ARDENNES               | 491556 | 56- MORBIHAN              |
| 491509 | 09 - ARIEGES                | 491557 | 57- MOSELLE               |
| 491510 | 10 - AUBE                   | 491558 | 58- NIEVRE                |
| 491511 | 11 - AUDE                   | 491559 | 59- NORD                  |
| 491512 | 12 - AVEYRON                | 491560 | 60- OISE                  |
| 491513 | 13 - BOUCHES DU RHONE       | 491561 | 61- ORNE                  |
| 491514 | 14 - CALVADOS               | 491562 | 62- PAS DE CALAIS         |
| 491515 | 15 - CANTAL                 | 491563 | 63- PUY DE DOME           |
| 491516 | 16 - CHARENTE               | 491564 | 64- PYRENEES ATLANTIQUES  |
| 491517 | 17 - CHARENTE MARITIME      | 491565 | 65- HAUTES PYRENEES       |
| 491518 | 18 - CHER                   | 491566 | 66- PYRENEES ORIENTALES   |
| 491519 | 19 - CORREZE                | 491567 | 67- BAS RHIN              |
| 491601 | 2A- CORSE DU SUD            | 491568 | 68- HAUT RHIN             |
| 491602 | 2B- HAUTE CORSE             | 491569 | 69- RHONE                 |
| 491521 | 21- COTE D'OR               | 491570 | 70- HAUTE SAONE           |
| 491522 | 22- COTES D'ARMOR           | 491571 | 71- SAONE ET LOIRE        |
| 491523 | 23- CREUSE                  | 491572 | 72- SARTHE                |
| 491524 | 24- DORDOGNE                | 491573 | 73- SAVOIE                |
| 491525 | 25- DOUBS                   | 491574 | 74- HAUTE SAVOIE          |
| 491526 | 26- DROME                   | 491575 | 75- PARIS                 |
| 491527 | 27- EURE                    | 491576 | 76- SEINE MARITIME        |
| 491528 | 28- EURE ET LOIRE           | 491577 | 77- SEINE ET MARNE        |
| 491529 | 29- FINISTERE               | 491578 | 78- YVELINES              |
| 491530 | 30- GARD                    | 491579 | 79- DEUX SEVRES           |
| 491531 | 31- HAUTE GARONNE           | 491580 | 80- SOMME                 |
| 491532 | 32- GERS                    | 491581 | 81- TARN                  |
| 491533 | 33- GIRONDE                 | 491582 | 82- TARN ET GARONNE       |
| 491534 | 34- HERAULT                 | 491583 | 83- VAR                   |
| 491535 | 35- ILE ET VILAINE          | 491584 | 84- VAUCLUSE              |
| 491536 | 36- INDRE                   | 491585 | 85- VENDEE                |
| 491537 | 37- INDRE ET LOIRE          | 491586 | 86- VIENNE                |
| 491538 | 38- ISERE                   | 491587 | 87- HAUTE VIENNE          |
| 491539 | 39- JURA                    | 491588 | 88- VOSGES                |
| 491540 | 40- LANDES                  | 491589 | 89- YONNE                 |
| 491541 | 41- LOIR ET CHER            | 491590 | 90- TERRITOIRE DE BELFORT |
| 491542 | 42- LOIRE                   | 491591 | 91- ESSONNE               |
| 491543 | 43- HAUTE LOIRE             | 491592 | 92- HAUTS DE SEINE        |
| 491544 | 44- LOIRE ATLANTIQUE        | 491593 | 93- SEINE SAINT DENIS     |
| 491545 | 45- LOIRET                  | 491594 | 94- VAL DE MARNE          |
| 491546 | 46- LOT                     | 491595 | 95- VAL D'OISE            |
| 491547 | 47- LOT ET GARONNE          | 491596 | 971- GUADELOUPE           |
| 491548 | 48- LOZERE                  | 491597 | 972- MARTINIQUE           |
|        |                             | 491598 | 973- GUYANE               |
|        |                             | 491599 | 974- LA REUNION           |
|        |                             | 491600 | 976- MAYOTTE              |



## TIFLEX

### LETTRÉ POUR PLAQUE PRÉPERCÉE HAUTEUR 45MM (X10)

|        |   |        |   |
|--------|---|--------|---|
| 450907 | A | 450920 | N |
| 450908 | B | 450923 | P |
| 450909 | C | 450924 | Q |
| 450910 | D | 450925 | R |
| 450911 | E | 450926 | S |
| 450912 | F | 450927 | T |
| 450913 | G | 450928 | U |
| 450914 | H | 450929 | V |
| 450916 | J | 450930 | W |
| 450917 | K | 450931 | X |
| 450918 | L | 450932 | Y |
| 450919 | M | 450933 | Z |



## TIFLEX

### NUMÉRO POUR PLAQUE PRÉPERCÉE HAUTEUR 45MM (X10)

|        |   |
|--------|---|
| 451599 | 0 |
| 450943 | 1 |
| 450944 | 2 |
| 450945 | 3 |
| 450946 | 4 |
| 450947 | 5 |
| 450948 | 6 |
| 450949 | 7 |
| 450950 | 8 |
| 450951 | 9 |

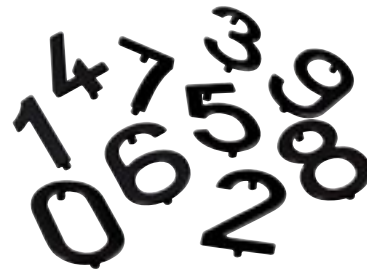

## TIFLEX

### DIVERS

455353 plomb (sachet)

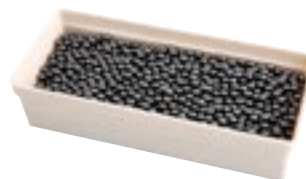

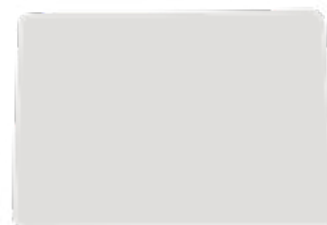
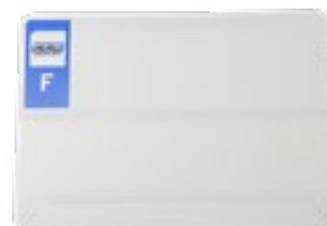
**S-P-M****IMPRIMANTE PLAQUE IMMATRICULATION****496603** disponible sous conditions**S-P-M****ROULEAU BANDE THERMIQUE 300M****496869** pour environ 700 plaques**S-P-M****PLAQUE D'IMMATRICULATION NR TRANSLUCIDE (X10)****496495** pour moto, scoter, cyclo | 210x130mm**S-P-M****PLAQUE D'IMMATRICULATION NR TRANSLUCIDE (X10)****496496** avec emplacement pour raison sociale ou publicité | 210x145mm**S-P-M****BANDE PLAQUE D'IMMATRICULATION AVEC EUROLOGO NR 210X145-130MM (X10)****496497** pour 50CC

# IMMATRICULATION / NUMBER PLATES

**S-P-M**

## BANDE PLAQUE D'IMMATRICULATION NR BLANCHE HYBRIDE 210X130-145MM SIV (X10)

|        |                            |
|--------|----------------------------|
| 496501 | 01 - AIN                   |
| 496502 | 02 - AISNE                 |
| 496503 | 03 - ALLIER                |
| 496504 | 04 - ALPES HAUTES PROVENCE |
| 496505 | 05 - HAUTES ALPES          |
| 496506 | 06 - ALPES MARITIMES       |
| 496507 | 07 - ARDECHE               |
| 496508 | 08 - ARDENNES              |
| 496509 | 09 - ARIEGES               |
| 496510 | 10 - AUBE                  |
| 496511 | 11 - AUDE                  |
| 496512 | 12 - AVEYRON               |
| 496513 | 13 - BOUCHES DU RHONE      |
| 496514 | 14 - CALVADOS              |
| 496515 | 15 - CANTAL                |
| 496516 | 16 - CHARENTE              |
| 496517 | 17 - CHARENTE MARITIME     |
| 496518 | 18 - CHER                  |
| 496519 | 19 - CORREZE               |
| 496521 | 21- COTE D'OR              |
| 496522 | 22- COTES D'ARMOR          |
| 496523 | 23- CREUSE                 |
| 496524 | 24- DORDOGNE               |
| 496525 | 25- DOUBS                  |
| 496526 | 26- DROME                  |
| 496527 | 27- EURE                   |
| 496528 | 28- EURE ET LOIRE          |
| 496529 | 29- FINISTERE              |
| 496530 | 30- GARD                   |
| 496531 | 31- HAUTE GARONNE          |
| 496532 | 32- GERS                   |
| 496533 | 33- GIRONDE                |
| 496534 | 34- HERAULT                |
| 496535 | 35- ILE ET VILAINE         |
| 496536 | 36- INDRE                  |
| 496537 | 37- INDRE ET LOIRE         |
| 496538 | 38- ISERE                  |
| 496539 | 39- JURA                   |
| 496540 | 40- LANDES                 |
| 496541 | 41- LOIR ET CHER           |
| 496542 | 42- LOIRE                  |
| 496543 | 43- HAUTE LOIRE            |
| 496544 | 44- LOIRE ATLANTIQUE       |
| 496545 | 45- LOIRET                 |
| 496546 | 46- LOT                    |
| 496547 | 47- LOT ET GARONNE         |
| 496548 | 48- LOZERE                 |
| 496549 | 49- MAINE ET LOIRE         |



|        |                           |
|--------|---------------------------|
| 496550 | 50- MANCHE                |
| 496551 | 51- MARNE                 |
| 496552 | 52- HAUTE MARNE           |
| 496553 | 53- MAYENNE               |
| 496554 | 54- MEURTHE ET MOSELLE    |
| 496555 | 55- MEUSE                 |
| 496556 | 56- MORBIHAN              |
| 496557 | 57- MOSELLE               |
| 496558 | 58- NIEVRE                |
| 496559 | 59- NORD                  |
| 496560 | 60- OISE                  |
| 496561 | 61- ORNE                  |
| 496562 | 62- PAS DE CALAIS         |
| 496563 | 63- PUY DE DOME           |
| 496564 | 64- PYRENEES ATLANTIQUES  |
| 496565 | 65- HAUTES PYRENEES       |
| 496566 | 66- PYRENEES ORIENTALES   |
| 496567 | 67- BAS RHIN              |
| 496568 | 68- HAUT RHIN             |
| 496569 | 69- RHONE                 |
| 496570 | 70- HAUTE SAONE           |
| 496571 | 71- SAONE ET LOIRE        |
| 496572 | 72- SARTHE                |
| 496573 | 73- SAVOIE                |
| 496574 | 74- HAUTE SAVOIE          |
| 496575 | 75- PARIS                 |
| 496576 | 76- SEINE MARITIME        |
| 496577 | 77- SEINE ET MARNE        |
| 496578 | 78- YVELINES              |
| 496579 | 79- DEUX SEVRES           |
| 496580 | 80- SOMME                 |
| 496581 | 81- TARN                  |
| 496582 | 82- TARN ET GARONNE       |
| 496583 | 83- VAR                   |
| 496584 | 84- VAUCLUSE              |
| 496585 | 85- VENDEE                |
| 496586 | 86- VIENNE                |
| 496587 | 87- HAUTE VIENNE          |
| 496588 | 88- VOSGES                |
| 496589 | 89- YONNE                 |
| 496590 | 90- TERRITOIRE DE BELFORT |
| 496591 | 91- ESSONNE               |
| 496592 | 92- HAUTS DE SEINE        |
| 496593 | 93- SEINE SAINT DENIS     |
| 496594 | 94- VAL DE MARNE          |
| 496595 | 95- VAL D'OISE            |
| 496596 | 971- GUADELOUPE           |
| 496597 | 972- MARTINIQUE           |
| 496598 | 973- GUYANE               |
| 496599 | 974- LA REUNION           |
| 496600 | 976- MAYOTTE              |
| 496601 | 2A-CORSE DU SUD           |
| 496602 | 2B-HAUTE CORSE            |

**S-P-M**

**INFO + :**  
disponible uniquement  
sur commande

# IMMATRICULATION / NUMBER PLATES

## BANDE PLAQUE D'IMMATRICULATION NR BLANCHE AUTO 520X110MM (X10)

|        |                            |
|--------|----------------------------|
| 496938 | 01 - AIN                   |
| 496939 | 02 - AISNE                 |
| 496940 | 03 - ALLIER                |
| 496941 | 04 - ALPES HAUTES PROVENCE |
| 496942 | 05 - HAUTES ALPES          |
| 496943 | 06 - ALPES MARITIMES       |
| 496944 | 07 - ARDECHE               |
| 496945 | 08 - ARDENNES              |
| 496946 | 09 - ARIEGES               |
| 496947 | 10 - AUBE                  |
| 496948 | 11 - AUDE                  |
| 496949 | 12 - AVEYRON               |
| 496950 | 13 - BOUCHES DU RHONE      |
| 496951 | 14 - CALVADOS              |
| 496952 | 15 - CANTAL                |
| 496953 | 16 - CHARENTE              |
| 496954 | 17 - CHARENTE MARITIME     |
| 496955 | 18 - CHER                  |
| 496956 | 19 - CORREZE               |
| 496957 | 21 - COTE D'OR             |
| 496958 | 22 - COTES D'ARMOR         |
| 496959 | 23 - CREUSE                |
| 496960 | 24 - DORDOGNE              |
| 496961 | 25 - DOUBS                 |
| 496962 | 26 - DROME                 |
| 496963 | 27 - EURE                  |
| 496964 | 28 - EURE ET LOIRE         |
| 496965 | 29 - FINISTERE             |
| 496966 | 30 - GARD                  |
| 496967 | 31 - HAUTE GARONNE         |
| 496968 | 32 - GERS                  |
| 496969 | 33 - GIRONDE               |
| 496970 | 34 - HERAULT               |
| 496971 | 35 - ILE ET VILAINE        |
| 496972 | 36 - INDRE                 |
| 496973 | 37 - INDRE ET LOIRE        |
| 496974 | 38 - ISERE                 |
| 496975 | 39 - JURA                  |
| 496976 | 40 - LANDES                |
| 496977 | 41 - LOIR ET CHER          |
| 496978 | 42 - LOIRE                 |
| 496979 | 43 - HAUTE LOIRE           |
| 496980 | 44 - LOIRE ATLANTIQUE      |
| 496981 | 45 - LOIRET                |
| 496982 | 46 - LOT                   |
| 496983 | 47 - LOT ET GARONNE        |
| 496984 | 48 - LOZERE                |
| 496985 | 49 - MAINE ET LOIRE        |



|        |                            |
|--------|----------------------------|
| 496987 | 51 - MARNE                 |
| 496988 | 52 - HAUTE MARNE           |
| 496989 | 53 - MAYENNE               |
| 496990 | 54 - MEURTHE ET MOSELLE    |
| 496991 | 55 - MEUSE                 |
| 496992 | 56 - MORBIHAN              |
| 496993 | 57 - MOSELLE               |
| 496994 | 58 - NIEVRE                |
| 496995 | 59 - NORD                  |
| 496996 | 60 - OISE                  |
| 496997 | 61 - ORNE                  |
| 496998 | 62 - PAS DE CALAIS         |
| 496999 | 63 - PUY DE DOME           |
| 497000 | 64 - PYRENEES ATLANTIQUES  |
| 497001 | 65 - HAUTES PYRENEES       |
| 497002 | 66 - PYRENEES ORIENTALES   |
| 497003 | 67 - BAS RHIN              |
| 497004 | 68 - HAUT RHIN             |
| 497005 | 69 - RHONE                 |
| 497006 | 70 - HAUTE SAONE           |
| 497007 | 71 - SAONE ET LOIRE        |
| 497008 | 72 - SARTHE                |
| 497009 | 73 - SAVOIE                |
| 497010 | 74 - HAUTE SAVOIE          |
| 497011 | 75 - PARIS                 |
| 497012 | 76 - SEINE MARITIME        |
| 497013 | 77 - SEINE ET MARNE        |
| 497014 | 78 - YVELINES              |
| 497015 | 79 - DEUX SEVRES           |
| 497016 | 80 - SOMME                 |
| 497017 | 81 - TARN                  |
| 497018 | 82 - TARN ET GARONNE       |
| 497019 | 83 - VAR                   |
| 497020 | 84 - VAUCLUSE              |
| 497021 | 85 - VENDEE                |
| 497022 | 86 - VIENNE                |
| 497023 | 87 - HAUTE VIENNE          |
| 497024 | 88 - VOSGES                |
| 497025 | 89 - YONNE                 |
| 497026 | 90 - TERRITOIRE DE BELFORT |
| 497027 | 91 - ESSONNE               |
| 497028 | 92 - HAUTS DE SEINE        |
| 497029 | 93 - SEINE SAINT DENIS     |
| 497030 | 94 - VAL DE MARNE          |
| 497031 | 95 - VAL D'OISE            |
| 497032 | 971 - GUADELOUPE           |
| 497033 | 972 - MARTINIQUE           |
| 497034 | 973 - GUYANE               |
| 497035 | 974 - LA REUNION           |
| 497036 | 976 - MAYOTTE              |
| 497041 | 2A - CORSE DU SUD          |
| 497042 | 2B - HAUTE CORSE           |

↳ INFO + :

disponible uniquement sur commande

**S-P-M**

**PLAQUE D'IMMATRICULATION NR AUTO  
520X110MM (X10)**

**496873** blanche



**S-P-M**

**BANDE PLAQUE D'IMMATRICULATION NR  
BLANCHE AUTO 520X110MM (X10)**

**496872** avec EUROLOGO



**S-P-M**

**BANDE PLAQUE D'IMMATRICULATION NR  
BLANCHE AUTO 520X110MM (X10)**

**496873** disponible sur commande uniquement

**S-P-M**

**BANDE PLAQUE D'IMMATRICULATION NR  
BLANCHE MOTO 100X100MM (X10)**

**497037** spécial enduro, non homologué

**497039** spécial enduro, trapèze non homologué



497037



497039

**S-P-M**

**PLAQUE D'IMMATRICULATION NR BLANCHE  
MOTO 100X100MM (X10)**

**497038** spécial enduro, non homologué

**497040** spécial enduro, trapèze non homologué



497038



497040



# SOLEX / POCKET BIKE

Pocket bike ..... 669

Sorex ..... 670

## MOTEUR



### ALLUMAGE

- 483211 lanceur
- 485403 bobine/CDI haute tension



483211



485403



### CARBURATION

- 485400 MD01 | MD03 | QD01



### PIPE D'ADMISSION

- 494810 pipe d'admission et clapet



### EMBRAYAGE

- 483212 complet



### TRANSMISSION

- 465065 couronne 54 dents | 3 trous | Ø intérieur 35mm
- 465066 pignon 17 dents
- 485401 chaîne

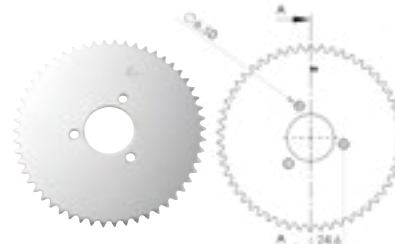

465065



465066



485401

## PNEUMATIQUE

### CHAMBRE À AIR

- 3669 4" 4.00 (4AB) valve coudée
- 494063 4" 4.00 valve coudée



3669





494063



PIÈCES MOTEUR

ALLUMAGE

461510 bobine h.t. 

3993 condensateur 

3991 rupteur 

467746 fil bougie 



461510



3993



3991



467746



ALLUMAGE

489599 bride/sangle capot volant (X1)

491035 cache volant noir



489599



491035



FILTRE

482190 filtre à air cylindrique

482191 capot filtre à air noir



482190



482191



CARBURATION

461511 carburateur





PIÈCES MOTEUR



CARBURATION

|        |                                   |             |
|--------|-----------------------------------|-------------|
| 485225 | gicleur                           | Ø26         |
| 482192 | gicleur                           | Ø27         |
| 482193 | gicleur                           | Ø28         |
| 485222 | gicleur                           | Ø29         |
| 482194 | gicleur                           | Ø30         |
| 485223 | gicleur                           | Ø31         |
| 485224 | gicleur                           | Ø32         |
| 493406 | durite essence transparent 5m     | 8x12        |
| 481802 | filtre essence                    | réservoir   |
| 481801 | filtre essence                    | carburateur |
| 481800 | bouchon essence                   |             |
| 461512 | pompe à essence                   | 3800/5000   |
| 491044 | pompe à essence                   | 2200        |
| 169856 | membrane pompe à essence          |             |
| 482263 | siège de membrane pompe à essence |             |
| 472304 | réservoir                         |             |
| 489596 | tuyau de refoulement              | 3800        |
| 472302 | tuyau d'aspiration                | 3800        |
| 494868 | kit de réparation 6 pièces        | 3800        |



482193



493406



481802



481801



481800



461512



169856



482263



472304



489596



472302



494868



MOTEUR

|        |                           |      |
|--------|---------------------------|------|
| 480895 | levier de relevage moteur | 3800 |
|--------|---------------------------|------|



PIÈCES MOTEUR

Sélection  
**CGN**

**EMBIELLAGE**

|        |   |       |          |
|--------|---|-------|----------|
| 7956   | roulement vilo 6203 renforcé C3         | droit | 17x40x12 |
| 7955   | roulement vilo 6203 renforcé cage acier | droit | 17x40x12 |
| 491042 | roulement vilo + joint spi              |       |          |
| 329887 | joint spi vilo                          |       |          |
| 487178 | écrou embiellage                        |       |          |



Sélection  
**CGN**

**JOINT**

|        |                        |                   |
|--------|------------------------|-------------------|
| 4132   | pochette joints moteur |                   |
| 490721 | pochette joints moteur | 4 joints+membrane |
| 4129   | joint                  | cylindre/embase   |
| 4126   | joint                  | culasse           |
| 167671 | joint                  | carter moteur     |

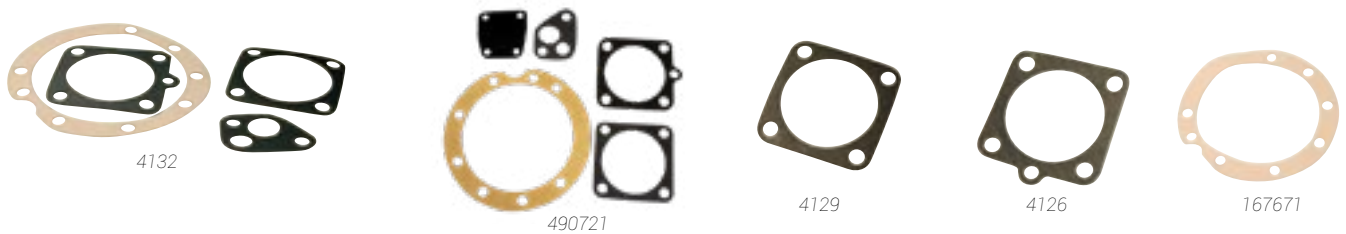

**TEKNIK**

**CYLINDRE/PISTON**

|        |   |            |
|--------|---|------------|
| 467752 | cylindre fonte (nu)                             |            |
| 491033 | cylindre fonte avec piston et pochette 5 joints |            |
| 467742 | piston  |            |
| 4113   | segment   | 39.50x1.70 |
| 491036 | cage à aiguille                                 | 12x20x14   |
| 491037 | cage à aiguille                                 | 12x18x12   |



## PIÈCES MOTEUR



### POT ÉCHAPPEMENT

|        |                |
|--------|----------------|
| 4162   | 3800/3300/2200 |
| 484514 | micron         |
| 484515 | 1010           |
| 484516 | 5000           |
| Joint  |                |
| 329872 | joint pot      |



### TRANSMISSION

|        |                      |
|--------|----------------------|
| 467744 | galet                |
| 489597 | ressort suspension   |
| 489598 | flexibloc/silentbloc |



### EMBAYAGE

|        |                      |
|--------|----------------------|
| 467748 | complet              |
| 486228 | garniture seule (x1) |



## PIECES CYCLES



### AUTOCOLLANT

|        |       |          |
|--------|-------|----------|
| 487474 | blanc | 2 pièces |
| 487473 | cadre | 6 pièces |



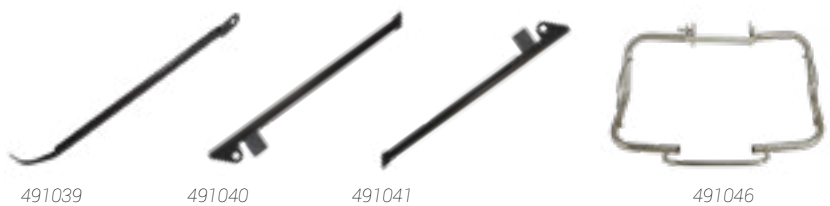

### TRINGLE DE GARDE-BOUE

|            |                   |        |
|------------|-------------------|--------|
| 491039     | arrière           |        |
| 491040     | avant             | droit  |
| 491041     | avant             | gauche |
| Pare-chocs |                   |        |
| 491046     | pare-chocs chrome |        |



PIECES CYCLES

ECLAIRAGE ARRIÈRE

- 491032 capot de phare optique sans optique 
- 480563 optique/phare 
- 484542 lampe/ampoule 14V 7W feu arrière E10 vissée 



491032



480563



484542



HOUSSE DE SELLE

- 472305 noir



BÉQUILLE

- 491031 axe béquille centrale
- 489603 ressort béquille



491031



489603



LEVIER

- 484795 levier de décompresseur
- 490720 levier/manette de décompresseur plastique



484795



490720



POIGNÉE

- 491047 gaz



FREINAGE

- 467743 patin frein avant (x1)



PÉDALE

- 491038 pas bsc (x2)



## PNEUMATIQUES



### PNEU

122738 19" 1 3/4 X 19 nervuré renforcé TT 21B



### CHAMBRE À AIR

|        |     |           |    |              |
|--------|-----|-----------|----|--------------|
| 483743 | 19" | 1-3/4   2 | VP | valve droite |
| 483744 | 19" | 1-3/4   2 | VS | valve droite |



## ATELIER



### BOÎTE À OUTILS

487177 vide



### ARRACHE-VOLANT

479586 3 vis



496357 3 vis



479586



496357

# MAXI-SCOOTER

|                 |     |
|-----------------|-----|
| Allumage        | 677 |
| Amortisseur     | 706 |
| Béquille        | 709 |
| Carburateur     | 688 |
| Carrosserie     | 710 |
| Clapet          | 687 |
| Compteur        | 712 |
| Contacteur      | 713 |
| Courroie        | 703 |
| Culasse         | 693 |
| Cylindre        | 691 |
| Direction       | 707 |
| Echappement     | 685 |
| Eclairage       | 711 |
| Embiellage      | 688 |
| Embrayage       | 701 |
| Filtre à air    | 683 |
| Filtre à huile  | 685 |
| Fourche         | 709 |
| Levier          | 714 |
| Refroidissement | 694 |
| Réservoir       | 705 |
| Rétroviseur     | 717 |
| Selle           | 719 |
| Variation       | 697 |

## INFO + :

Retrouvez les bougies maxi-scooters **page 37**.

## ALLUMAGE



### BOBINE HAUTE TENSION EXTÉRIURE

|               |  |
|---------------|--|
| <b>168386</b> | PEUGEOT   X9   X8                                    |
| <b>482610</b> | X7   X8   X9   VESPA LX   GT   AGILITY monté origine |
| <b>485686</b> | HONDA 125 SHI   PANTHEON   S-WING                    |
| <b>490618</b> | 125 SYM HD   EVO 50 TWEET   FIGHT 3                  |
| <b>490619</b> | 125 KYMCO DOWNTOWN   PEOPLE   50 APRILIA SR          |
| <b>490617</b> | 125   250   300   500 PIAGGIO   PEUGEOT   GILERA     |



168386



482610



485686



490618



490619



490617



### BLOC CDI

|               |   |
|---------------|---|
| <b>490621</b> | KYMCO 125 DINK 2008->                         |
| <b>490622</b> | KYMCO 125 GRAND DINK 2001->2008   DINK ->2000 |
| <b>490620</b> | KYMCO AGILITY 125 R16 2008->   SUPER 2008->   |
| <b>479194</b> | SCOOTER CHINOIS 125 (152QM)                   |
| <b>485684</b> | SYM JOYRIDE   FIDDLE II   SYMPHONY   SYMPLY   |



490621



490622



490620



479194



485684



### BLOC CDI

|               |                                       |
|---------------|---------------------------------------|
| <b>488117</b> | VESPA PX 125   200 ET3 PK 125   P200E |
|---------------|---------------------------------------|

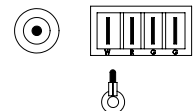

ALLUMAGE



BOBINE CDI HAUTE TENSION

485685 VESPA 50 | 125 PX



DÉMARREUR TYPE ORIGINE

482832 125 SYM 4 temps | sens de rotation horaire



DÉMARREUR

|   | Sens de rotation |
|---|------------------|
| 488104 125 X-MAX   SKYCRUISER   EVOLIS type origine                     | horaire          |
| 490641 125 HONDA SH   DYLAN   PANTHEON   PS 31200KGF901   902           | horaire          |
| 490642 125 KYMCO AGILITY R12   16   DINK   GRAND DINK   SYM FIDDLE 2008 | horaire          |
| 490643 125 KYMCO GRAND DINK   DINK 2001 ->2013 0012751-00128219         |                  |
| 485713 125 SYM GTS   JOYRIDE   JOYMAX                                   |                  |
| 485711 125 DINK AM   PEOPLE   HEROISM   FIDDLE II   ORBIT   SYMPLY      | horaire          |
| 485712 125 DINK   GRAND DINK ->2007                                     |                  |
| 482831 125 PIAGGIO X7   X8   X9   X EVOLUTION   FLY   LIBERTY 4 temps   | horaire          |
| 482830 125 MAJESTY   CYGNUS   SKYLINER                                  | anti-horaire     |
| 466794 125 SCOOTER CHINOIS  | horaire          |
| 490629 400   500 FUECO   MP3   SATELIS   SCARABEO                       | horaire          |
| 491459 125   150   200   400 SUZUKI BURGMAN                             | horaire          |
| 495697 500   530 YAMAHA TMAX  | horaire          |



488104



490641



490642



490643



485713



485711



485712



482831



482830



466794



490629



491459



495697



## ALLUMAGE



## ROUE-LIBRE DÉMARREUR TYPE ORIGINE

|               |                               |
|---------------|-------------------------------|
| <b>482833</b> | 125 XMAX   SKYCRUISER         |
| <b>482834</b> | 125 MAJESTY   SKYLINER 2006-> |
| <b>488125</b> | 125 BURGMAN                   |
| <b>488124</b> | 500-530 T-MAX 50              |

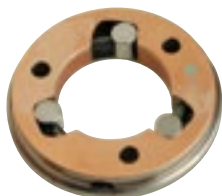

482833



482834



488125



488124



## ROUE-LIBRE DÉMARREUR

|               |   |
|---------------|---|
| <b>489499</b> | 125 X-MAX   SKYCRUISER 2006->2011       |
| <b>489502</b> | 125   150 HONDA SH                      |
| <b>489503</b> | 125   150 BURGMAN 2002->2011            |
| <b>489501</b> | 125   180 MAJESTY   SKYLINER 2003->2009 |
| <b>487262</b> | 125 KYMCO AGILITY                       |



489499



489502



489503



489501



487262





RÉGULATEUR DE TENSION

|  |  |   |  |
|--|--|---|--|
| <br><b>484659</b>   | <br><b>484660</b>   | <br><b>490628</b>   | <br><b>490625</b>   |
| <p>125 XMAX   SKYCRUISER -&gt;2010</p>   | <p>125 XMAX 2010-&gt;   PEUGEOT   YZF 125</p>  | <p>125 XMAX 2012-&gt;2013   CYGNUS   FLAME 2004-&gt;   YZF 2010-&gt;</p>                              | <p>125 HONDA SHI 2005-&gt;2012</p>   |
| <br><b>484658</b>   | <br><b>484661</b>   | <br><b>484657</b>   | <br><b>490627</b>   |
| <p>250 HONDA SH-PANTHEON   PIAGGIO X9</p>  | <p>125 PIAGGIO   PEUGEOT tous modèles</p>  | <p>125 SYM   KYMCO   HONDA   PIAGGIO   MALAGUTI</p>   | <p>125   500 KYMCO DOWNTOWN   500 X-CITING</p>   |
| <br><b>490626</b>  | <br><b>490623</b>  | <br><b>480414</b>  | <br><b>490408</b>  |
| <p>125   400 BURGMAN 2007-&gt;2010</p>   | <p>125 MAJESTY   SKYLINER 1998-&gt;2000</p>  | <p>125 MAJESTY   SKYLINER   ELYSEO</p>  | <p>125 TWEET   SYMPHONY   FIDDLE 2   JET 4</p>   |
| <br><b>490624</b> | <br><b>485692</b> | <br><b>485693</b> | <br><b>488118</b> |
| <p>125 AGILITY 2008-&gt;2009</p>   | <p>50   125 VESPA</p>  | <p>250   400   500 PEUGEOT   APRILIA   PIAGGIO</p>  | <p>500 YAMAHA TMAX 2008-&gt;2009</p>   |





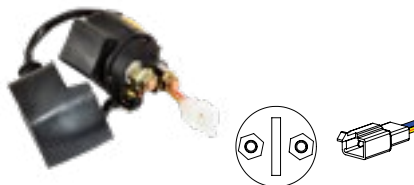







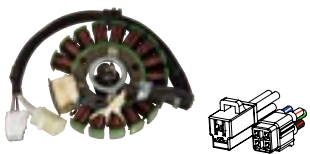
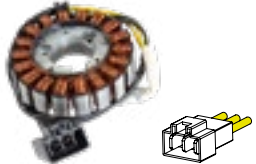





RELAJ DE DÉMARREUR

|  |  |  |
|--|--|--|
| <br><b>450782</b> | <br><b>207752</b> | <br><b>484655</b> |
| <p>PIAGGIO 50   125</p>  | <p>BOOSTER -&gt;2003   TMAX500   F12   MAJE</p>  | <p>4 temps 12V 100 AH</p>  |

# PARTIE MOTEUR / ENGINE PART

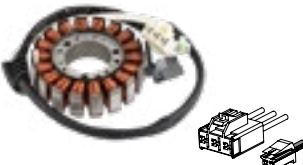
**TEKNIX** STATOR

**MAXI-SCOOTER**

|  |  |  |  |
|--|--|--|--|
|  <p><b>480391</b></p>   |  <p><b>490614</b></p>   |  <p><b>485709</b></p>    |  <p><b>490406</b></p>   |
| <p>125 SKYLINER   MAJESTY</p>  | <p>125 HONDA SHI 2005-&gt;2012  <br/>125 SH 2001-&gt;2004</p>  | <p>125 PIAGGIO moteur LEADER 12<br/>pôles 828135-584690-833697</p>   | <p>125 SYM GTS JOYMAX  <br/>JOYRIDE   HD   EVO</p>   |
|  <p><b>490609</b></p>   |  <p><b>490607</b></p>   |  <p><b>490606</b></p>    |  <p><b>490608</b></p>   |
| <p>125 KYMCO AGILITY R12 4<br/>temps 2006-&gt;2009 00128172</p>  | <p>125 KYMCO DINK 2006-&gt;2010<br/>carbu   GRAND DINK<br/>2008-&gt;2009 carbu</p>                       | <p>125 KYMCO DINK   GRAND DINK<br/>00128947</p>  | <p>125 KYMCO PEOPLE<br/>2005-&gt;2010 00128184</p>   |
|  <p><b>490407</b></p>  |  <p><b>485708</b></p>  |  <p><b>490615</b></p>   |  <p><b>490616</b></p>  |
| <p>125 VESPA GTS   X10   MP3<br/>YOURBAN 58202R-385224R</p>  | <p>125 VESPA PX 217866</p>   | <p>VESPA 125 PK   XL 3 pôles<br/>199495</p>  | <p>VESPA   APE 50   125 PK 5 pôles<br/>199500</p>  |
|  <p><b>490610</b></p> |  <p><b>485710</b></p> |  <p><b>490611</b></p>  |  <p><b>490612</b></p> |
| <p>125   300 PIAGGIO VESPA GTS<br/>2009-&gt;2013   MP3 YURBAN<br/>2011-&gt;2012</p>                      | <p>400   500 PIAGGIO MP3 58108R<br/>  GEOPOLIS</p>   | <p>500 YAMAHA TMAX 2001-&gt;2003<br/>5GJ814100100</p>  | <p>500 YAMAHA TMAX 2004-&gt;2007<br/>5VU814100200</p>  |
|  <p><b>490613</b></p> |  <p><b>493135</b></p> |  <p><b>493136</b></p> |  |
| <p>500 YAMAHA TMAX 2008-&gt;<br/>4B5-81410-00-00</p>   | <p>125 YAMAHA XMAX   MBK SKYCRUISER<br/>2006-&gt;</p>  | <p>530 YAMAHA TMAX 2012-&gt;</p>   |  |

ALLUMAGE



RUPTEUR

485691 VESPA 50 | 125 (référence origine 101761)

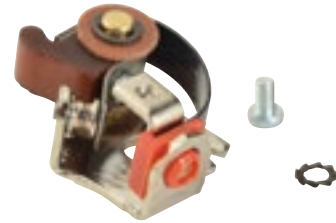

CONDENSATEUR

485689 VESPA 50 | 125 référence origine 078937

485690 VESPA 50 | 125 référence origine 079697



485689



485690



COURONNE/PIGNON LANCEUR DÉMARREUR

488127 500 | 530 T MAX

488126 125 X-MAX | SKYCRUISER | EVOLIS

489500 125 BURGMAN



488127



488126



489500



PIGNON LANCEUR DÉMARREUR

489498 PIAGGIO | VESPA 125

489497 PIAGGIO 4 temps | GPR

489496 SR 2004-> | LIBERTY | TYPHOON



489498



489497



489496



AXE KICK

485721 PIAGGIO LIBERTY | VESPA | ZIP moteur LEADER (830284)

468853 SCOOTER CHINOIS 4 temps 125CC/152QMI



485721



468853

## FILTRE À AIR



### FILTRE À AIR

- 483503** 500 YAMAHA T-MAX 2001->2007
- 483504** 500 | 530 YAMAHA T-MAX 2008 ->



483503



483504



### FILTRE À AIR

- 484545** 125 HONDA PCX ->2011
- 488704** 125 HONDA PCX 2012->
- 485680** 125 HONDA SH | DYLAN 2001->2008
- 491455** 125 HONDA SH | DYLAN 2013->2014
- 485673** 125 SYM GTS EVO | JOYRIDE
- 485677** 125 SUZUKI BURGMAN 2007->2012
- 478423** 125 KYMCO GRAND DINK 2001->2005
- 450792** 125 SKYLINER | THUNDER | MAJESTY 2
- 478425** 125 | 150 | 180 | MAJESTY | SKYLINER |
- 478424** 125 | 250 XMAX | 125 SKYCRUISER 05
- 468833** 125 4 temps SCOOTER CHINOIS 152QMI Ø123mm
- 491457** 125 KYMCO AGILITY R16 2008->
- 491456** 125 | 300 KYMCO GRAND DINK 2012->
- 488149** 500 | 530 YAMAHA TMAX XP 2008->



484545



488704



485680



491455



485673



485677



478423



450792



478425



478424



468833



491457



491456



488149

FILTRE À AIR



FILTRE À AIR

- 478418** 500 YAMAHA TMAX XP 2001->2007
- 478420** 500 | 530 YAMAHA TMAX XP 2008->
- 478419** 500 YAMAHA TMAX 2001->2007 côté gauche
- 491458** 530 YAMAHA TMAX 2012 côté gauche
- 496087** 125 HONDA FORZA 2015-> cartouche
- 491951** 125 HONDA SH | DYLAN 2015-> cartouche
- 494321** 125 KYMCO DOWNTOWN i 2009->
- 496085** 125 YAMAHA | MBK NMAX | OCITO 2015
- 496086** 125 YAMAHA | MBK TRICITY | TRIPTIK
- 492195** BETA RR50 ->2014 | CPI SM SX
- 492196** BETA RR50 2015->
- 491435** RIEJU 50 MRT
- 487244** RS4 | RS | SC | GPR 2009->2010 | SENDA DRD RACING
- 492197** SHERCO SM-R | SE-R
- 493328** SYM ORBIT 2 | VIVACITY 3 | SPEEDFIGHT 3



478418



478420



478419



491458



496087



491951



494321



496085



496086



492195



492196



491435



487244



492197



493328



MOUSSE FILTRE À AIR

- 450793** BOOSTER 100 | OVETTO 100
- 450799** ELYSEO | SPEEDFIGHT | TREKKER
- 477381** X8 PIAGGIO | VESPA GTS | GTV
- 485675** 125 | 150 SUZUKI BURGMAN
- 482111** VESPA LX | S | LIBERTY | FLY | 125LX
- 482112** LIBERTY 4 temps 125 2003->2012
- 478108** PIAGGIO X9 2001->2002 | DNA | RUNNER
- 477382** 125 | 400 X7 | X9 | X10 | BEVERLY



450793



450799



477381



485675



482111



482112



478108



477382

## INFO + :

Retrouvez les affectations complètes des filtres à huile sur notre **WinCGN**.

## FILTRE À HUILE



### FILTRE À HUILE

**478086** 125 SKYCRUISER | X MAX | X CITY

**478085** VESPA | FLY | X7 | X8 | X9 | 125 | 250



478086



478085



**450791**

FLAME 125 | CYGNUS HF143



**478083**

125 SATELIS | JETFO HF185



**487432**

125 DINK | GRAND DINK HF562



**450789**

ET4 | LIBERTY | LX-4 HF181



**478084**

125 | 400 BURGMAN | GT | COMET



**489951**

BMW C600 | C650 HF164



**487429**

650 BURGMAN HF138



**478088**

400 | 500 SATELIS HF184



**478087**

500 | 530 T MAX | 60 HF147



**494343**

125 SKYCRUIS HF141



**487428**

125 VARADERO | SHADOW HF113



**487430**

YAMAHA XT | XV | TDM | MT03 HF145



**487431**

CBR | VFR | HORNET | ER6 | Z750 HF204



**493942**

CB 500 | HORNET | Z750 | 1000 HF3



**494342**

VESPA | FLY | X7 | X8 HF183



**494377**

KYMCO 125 DOWNTOWN HF566

FILTRE À HUILE



|  |  |   |  |
|--|--|---|--|
| <br><b>496660</b>   | <br><b>496663</b>   | <br><b>496666</b>   | <br><b>496680</b>   |
| 125 FLAME   CYGNUS MIW 143   | 500   530 TMAX   600 FAZER<br>1998->2000 MIW 147   | 600   650 BMW C600   C650 MIW<br>164  | 125 DAELIM S1   S2   OTELLO<br>MIW 168   |
| <br><b>496659</b>   | <br><b>496667</b>   | <br><b>496664</b>   | <br><b>496661</b>   |
| 125 ET4   LIBERTY   LX-4 MIW<br>181  | 125   250   300 VESPA   FLY   X7  <br>X8 MIW 183   | 400   500 SATELIS   GEOPOLIS<br>MIW 184   | 125 SATELIS   JETFORCE  <br>ELYSEO MIW 185   |
| <br><b>497120</b>   | <br><b>496665</b>   | <br><b>496681</b>   | <br><b>496668</b>   |
| 400 PEUGEOT METROPOLIS<br>MIW 191  | 125 DINK   GRAND DINK<br>MIW 562   | 850 APRILIA SRV 2012->  <br>800 MIW 565   | 125 KYMCO DOWNTOWN<br>2009-> MIW 566   |
| <br><b>496683</b> | <br><b>496662</b> | <br><b>496684</b> | <br><b>496685</b> |
| 300 HONDA SH   400   600 MIW<br>951  | 125   400 BURGMAN   GT 125  <br>250 MIW 971  | 250   400 SUZUKI BURGMAN  <br>400 MIW 972   | 650 SUZUKI BURGMAN 2002-><br>MIW 975   |
| <br><b>496679</b> | <br><b>496669</b> | <br><b>496677</b> | <br><b>496670</b> |
| 500   530 TMAX   600 FAZER<br>1998->2000 MIW 985   | 650 BURGMAN   GSR600   GS<br>MIW 138   | 125 XMAX   EVOLIS   YZF-R<br>MIW 140  | 125 SKYCRUISER   X MAX<br>MIW 141  |
| <br><b>496674</b> | <br><b>496675</b> | <br><b>496676</b> | <br><b>496671</b> |
| 125 VARADERO   SHADOW<br>MIW 113   | 150   250   450 HONDA CRF  <br>HUSQVARNA MIW 116   | 125 HYOSUNG COMET   AQUILA<br>  125 SUZUKI MIW 131  | YAMAHA XT   XV   TDM   MT03  <br>RAPTOR MIW 14   |
| <br><b>496672</b> | <br><b>496673</b> | <br><b>496678</b>  | <br><b>496682</b> |
| CBR   VFR   HORNET   ER6   Z750<br>  FZ6   XJ6   FZ8 MIW 204   | CB 500   HORNET   Z750   1000  <br>Z300   ER5 MIW 303  | 250   300   350   400   450   530<br>KTM EXC   SX MIW 652   | 650 HYOSUNG GT   COMET   GV<br>AQUILA   ST7 MIW 681  |



## FILTRE À HUILE

Sélection  
**CGN**

## CRÉPINE FILTRE À HUILE

490404 HONSA SH 125 | KYMCO | PIAGGIO



## CLAPET

polini

## CLAPET

486807 VESPA 50 | 125



## CARBURATION

Sélection  
**CGN**

## CARBURATEUR

468829 4 temps SCOOTER CHINOIS 125CC | 152QMI Ø24mm

483341 125 4 temps KEIHIN origine TYPE DELLORTO Ø24mm



468829



483341

TOP  
performance

## BOISSEAU CARBURATEUR

482824 125 YAMAHA MINARELLI | MAJESTY | SKYLINER



TEKNIX

## BOISSEAU CARBURATEUR

487822 4 temps SCOOTER CHINOIS 125CC avec membrane, aiguille et clips

487821 SCOOTER CHINOIS 50CC 4 temps membrane et aiguille



CARBURATION



RÉGULATEUR DE PRESSION INJECTION

488120 T-MAX 500 | 530 3.5 bars



PIPE ADMISSION



PIPE D'ADMISSION

- 482822 PIAGGIO | GILERA 125 2 temps
- 482823 YAMAHA | MBK | MINARELLI 125 2 temps
- 490430 PIAGGIO 125 4 temps type origine
- 490431 KYMCO 125 AGILITY 4 temps



482822



482823



490430



490431



PIPE D'ADMISSION

468837 SCOOTER CHINOIS 125CC 152QMI 4 temps



EMBIELLAGE | ROULEMENT



EMBIELLAGE TYPE ORIGINE

- 488114 125 SYM SYMPHONY
- 488115 125 AGILITY
- 488112 125 VESPA ET3
- 488113 125 VESPA PX
- 473371 125 SKYLINER | MAJE
- 494594 125 X-MAX | SKYCRUISE



## EMBIELLAGE | ROULEMENT



## EMBIELLAGE

|        |                             |
|--------|-----------------------------|
| 483335 | MAJESTY   SKYLINER 125      |
| 485707 | PIAGGIO 125   150 PX 133154 |



## EMBIELLAGE MADE IN CE

|        |                        |
|--------|------------------------|
| 485235 | 125 X-MAX   SKYCRUISER |
| 494096 | 125 HONDA PCX          |
| 494098 | 125 KYMCO DOWNTOWN     |
| 494097 | 125   150 HONDA SH     |



## ROULEMENT VILO ET JOINT SPI TYPE ORIGINE

|        |             |
|--------|-------------|
| 488123 | 125 MAJESTY |
|--------|-------------|



## ROULEMENT VILO ET JOINT SPI TYPE ORIGINE

|        |                  |
|--------|------------------|
| 490399 | 125   400 SUZUKI |
|--------|------------------|



POCHETTE DE JOINT



POCHETTE JOINT HAUT-MOTEUR

|        |                                      |    |
|--------|--------------------------------------|----|
| 483367 | ET4   LX   ZIP   TYPHOON   SR MOTARD | x6 |
| 483368 | KYMCO DINK 125                       | x3 |
| 483366 | FLAME   CYGNUS 125                   | x5 |
| 483365 | MAJESTY   SKYLINER 125               | x3 |

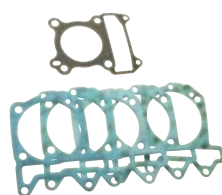

483367



483368

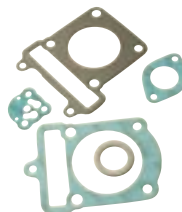

483366



483365



POCHETTE JOINT HAUT-MOTEUR

|        |                              |
|--------|------------------------------|
| 482221 | X-MAX   SKYCRUISER 125   YZF |
|--------|------------------------------|

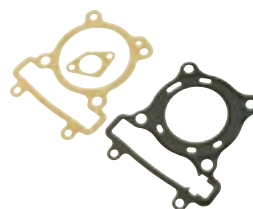

POCHETTE JOINT MOTEUR

|        |   |
|--------|---|
| 483371 | 125 KYMCO DINK EURO 2                       |
| 483370 | 125 FLAME   CYGNUS                          |
| 483369 | 125 MAJESTY   SKYLINER                      |
| 490345 | 125 XMAX   SKYCRUISER                       |
| 490346 | 125 MP3 2007->2008   GRANTURISMO 2007->2009 |
| 490347 | X7 EVO IE   BEVERLY 2008->2010              |
| 490348 | AGILITY EURO 3   PEOPLE 125                 |
| 490350 | 125 SYM GTS   JOYRIDE   HD                  |
| 490349 | 125 KYMCO DINK   GRAND DINK EURO 3          |
| 490351 | 125 TWEET   SYMPHONY   JET 4   EURO MX      |

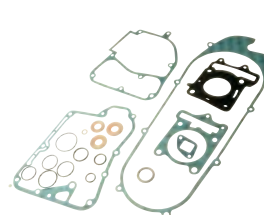

483371

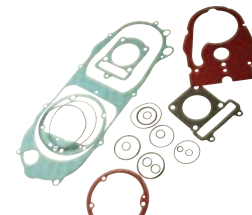

483370

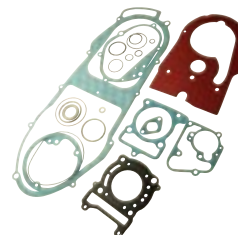

483369



490345



490346



490347



490348



490350



490349



490351



490352

## POCHETTE DE JOINT

Sélection  
**CGN**

## JOINT SPI COMPLET

486024 500 | 530 T-MAX 2001-&gt;

Sélection  
**CGN**

## JOINT SPI VILO (X1)

490417 125 X-MAX | EVOLIS | SKYCRUISER 25x40x5



## CYLINDRE

**AIRSGL**  
The power of engines

## CYLINDRE ALU NIKASYL MADE IN CE

483424 125 XMAX | SKYCRUISER | YZF | EVOLIS

483640 125 HONDA SH -&gt;2012

496217 125 HONDA SHI | PCX 2012-&gt;

496216 125 XMAX | SKYCRUISER | YZF | EVOLIS | T6

**TEKNIX**

## CYLINDRE ALU NIKASYL MADE IN CE

478897 125 XMAX | SKYCRUISER | 125 YZF alu chemisé fonte

478898 125 SCOOTER CHINOIS 4 temps 152QMI alu

485398 125 MAJESTY | SKYLINER fonte

495042 125 AGILITY | LIKE | PEOPLE | SUPER 8 alu chemisé fonte

**TEKNIX**

## PIÈCES DÉTACHÉES

482201 piston X-MAX | SKYCRUISER 125 | YZF cylindre alu

482202 segment X-MAX | SKYCRUISER 125 Ø52mm jeu



CYLINDRE



PISTON

|        |                                  |
|--------|----------------------------------|
| 496224 | 125 HONDA SH ->2012 made in CEE  |
| 496227 | 125 HONDA SHI   PCX 2012->       |
| 496234 | 125 XMAX   SKYCRUISER   YZF      |
| 496232 | 125 XMAX   SKYCRUISER   YZF   T6 |



JOINT TENDEUR DISTRIBUTION

|        |                              |
|--------|------------------------------|
| 485012 | 125 X-MAX   SKYCRUISER   YZF |
|--------|------------------------------|



JOINT



JOINT HAUT MOTEUR

|        |                                   |
|--------|-----------------------------------|
| 496225 | 125 HONDA SH ->2012               |
| 496229 | 125 HONDA SHI   PCX 2012->        |
| 496236 | 125 X-MAX   SKYCRUISER            |
| 496233 | 125 X-MAX   SKYCRUISER   YZF   T6 |



JOINT HAUT MOTEUR

|        |  |
|--------|--|
| 486018 | 125 BURGMAN UH 2007-> culasse + embase       |
| 486015 | 125 PCX 2010->2011 culasse + embase          |
| 486016 | HONDA 125 PCX 2012-> culasse + embase        |
| 486019 | SYM FIDDLE II   SYMPHONY   X PRO 2009->      |
| 486020 | SYM JOYRIDE   GTS JOYMAX 2003->2010          |
| 486017 | VES PA 125 LX 4 temps 2006->2012             |
| 486021 | YAMAHA 500 T-MAX 2001->2011 culasse + embase |
| 486023 | YAMAHA 530 T-MAX 2012-> culasse + embase     |

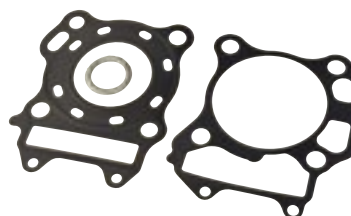

JOINT DE CULASSE

|        |                              |
|--------|------------------------------|
| 485010 | 125 X MAX   SKYCRUISER   YZF |
|--------|------------------------------|



## CULASSE



### CHAÎNE DE DISTRIBUTION

468826 SCOOTER CHINOIS 125CC 152QM 4 temps



### ARBRE À CAME

491485 125 X-MAX | SKYCRUISER | EVOLIS | YZF

491486 125 MAJESTY | SKYLINER



### ARBRE À CAME

468824 SCOOTER CHINOIS 125CC | 152QMI 4 temps



## REFROIDISSEMENT



### MÉCANISME DE POMPE À EAU TYPE ORIGINE

488119 125 HONDA PCX

482821 125 KYMCO DINK

482819 125 YAMAHA YP

480383 125 YAMAHA X-MAX | SKYCRUISER | EVOLIS

494763 125 KYMCO DOWNTOWN



488119



482821



494763



482819

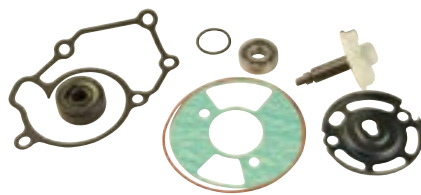

480383

REFROIDISSEMENT



MÉCANISME DE POMPE À EAU

- 483298** 125 X-MAX | SKYCRUISER 2 | EVOLIS | YZF
- 482820** 125 PIAGGIO 4 temps
- 483300** 125 HONDA SH | PANTHEON
- 466774** 125 MAJESTY | SKYLINER
- 485662** 400 PIAGGIO MP3 2007->
- 495694** 125 X-MAX | SKYCRUISER



483298



482820



483300



466774



485662



495694



MÉCANISME DE POMPE À EAU TYPE ORIGINE

- 484619** 500 YAMAHA T-MAX 2001->2007
- 484620** 500 | 530 YAMAHA T-MAX 2008->



484619



484620



MÉCANISME DE POMPE À EAU TYPE ORIGINE

- 485661** 125 SUZUKI BURGMAN





## ÉCHAPPEMENT

**DOPPLER****POT D'ÉCHAPPEMENT S100**

368363 100 PEUGEOT SPEEDFIGHT | VIVACITY 2 temps

**SITO****POT D'ÉCHAPPEMENT**

483049 125 LIBERTY | FLY | VESPA ET4 | LX 4 temps

3308 125 VESPA PX

**YASUNI****POT D'ÉCHAPPEMENT 4**

478605 125 X MAX | SKYCRUISER | EVOLIS

491424 125 VESPA GTS 2008-&gt;

491426 125 HONDA SH 2005-&gt;2012

491427 125 HONDA PCX 2010-&gt;2015 | SH 2013-&gt;

491429 125 SUZUKI BURGMAN 2014-&gt;

491431 125 KYMCO SUPERDINK | DINK STREET | KAWASAKI

491432 125 KYMCO AGILITY CITY 2012-&gt;

485612 125 PIAGGIO BEVERLY

491430 200 SUZUKI BURGMAN 2014-&gt;

491423 350 PIAGGIO BEVERLY 2012-&gt;

491425 300 VESPA 2008-&gt;

491428 300 HONDA SH 2012-&gt;2014

493836 125 HONDA FORZA

494285 125 NMAX | OCITO

494286 125 TRICITY

493007 530 YAMAHA TMAX TITANE --&gt;2016

**YASUNI****POT D'ÉCHAPPEMENT 4 ÉDITION NOIR ET CARBONE**

493837 125 HONDA FORZA édition noir carbone

493835 125 HONDA PCX 2010-&gt;2015 | SH 2013-&gt;

494284 125 NMAX | OCITO édition noir et carbone

494287 125 TRICITY édition noir et carbone

494276 125 X MAX | SKYCRUISER | EVOLIS

493838 300 KAWASAKI J300 édition noir et carbone

493008 400 X-MAX | EVOLIS édition noir carbone

495811 500 PIAGGIO MP3 édition noir carbone

493834 530 YAMAHA TMAX édition noir carbone



ÉCHAPPEMENT



POT D'ÉCHAPPEMENT INOX

|        |                                     |
|--------|-------------------------------------|
| 492429 | 125 HONDA FORZA                     |
| 492430 | 125 YAMAHA   MBK XMAX-   SKYCRUISER |



POT D'ÉCHAPPEMENT INOX NOIR

|        |                                  |
|--------|----------------------------------|
| 495292 | 125 KYMCO DOWNTOWN 2009->2015    |
| 495158 | 125 SYM JOYMAX 125I 2015-> noir  |
| 495293 | 125 YAMAHA TRICITY   MBK TRYPTIK |
| 492428 | 400 PEUGEOT METROPOLIS noir      |



POT D'ÉCHAPPEMENT ORIGINAL NOIR

|        |                       |
|--------|-----------------------|
| 493004 | 125 SYM GTS i 4 temps |
|--------|-----------------------|



JOINT POT

|        |                                 |               |
|--------|---------------------------------|---------------|
| 489830 |                                 | 31x40x3       |
| 490402 | 125 X-MAX   SKYCRUISER   EVOLIS | 32x42x3       |
| 490400 | PCX   DINK   GRAND DINK         | 26x33x3.5     |
| 490401 | MAJESTY   FLAME                 | 24.8x37.4x4.3 |
| 490403 | 500 T-MAX 2001->2011            | 30x39x4       |



CATALYSEUR POT

|        |                                |
|--------|--------------------------------|
| 491433 | HONDA SH 125   PIAGGIO BEVERLY |
|--------|--------------------------------|



EMBOUT SILENCIEUX

|        |                          |
|--------|--------------------------|
| 468247 | T-MAX carbone avec diode |
|--------|--------------------------|



## INFO + :

Retrouvez les galets pour maxi-scooter **page 194.**

## VARIATION



## VARIATEUR MULTIVAR 2000

|        |                                  |         |
|--------|----------------------------------|---------|
| 477596 | 125 SUZUKI BURGMAN               | 20x17   |
| 478044 | 125 SYM GTS EURO 3               | 20x17   |
| 480258 | 125 KYMCO GRAND DINK             | 20x17   |
| 477532 | 125 KYMCO SUPER DINK             | 20x17   |
| 479987 | 125 HONDA PCX ie EURO 3          | 20x17   |
| 468760 | 125 PEUGEOT SATELIS 4 temps      | 20x17   |
| 468761 | 125 PEUGEOT SATELIS compressor   | 20x17   |
| 484506 | 125 YAMAHA   MBK FLAME           |         |
| 461352 | 125 PIAGGIO X10   X9   X8   X7   | 20x17   |
| 461354 | 125   150 XMAX   MAJESTY liquide | 20x17   |
| 472118 | 250 YAMAHA   MBK X-MAX           | 20x12   |
| 479796 | 200   250   300 X8 X9   VESPA    | 20x17   |
| 487448 | 400 KYMCO XCITING                |         |
| 477636 | 400   500 SATELIS   X9           |         |
| 461356 | 500 T-MAX 2004-> injection       | 25x14.9 |
| 482149 | 530 T-MAX 2012->2016             | 25x14.9 |
| 483745 | 600   650 BMW                    | 29.8x30 |
| 497284 | 530 TMAX 2017->                  |         |
| 461355 | 500 TMAX ->2003                  |         |



## VARIATEUR OVER RANGE

|        |                      |         |
|--------|----------------------|---------|
| 482646 | 530 T-MAX 2012->2016 | 25x14.9 |
| 497405 | 530 TMAX 2017->      |         |



## VARIATION



## PIÈCES DÉTACHÉES VARIATEUR

## Guide

|               |                  |      |
|---------------|------------------|------|
| <b>479803</b> | Multivar 2000 x3 | noir |
| <b>479053</b> | Multivar 2000 x3 | noir |

## Ressort

|               |  |       |
|---------------|--|-------|
| <b>489968</b> | 125 BURGMAN   SIXTEEN                        | blanc |
| <b>489957</b> | 125 SH   PS   AGILITY   DINK STREET          | blanc |
| <b>489965</b> | MP3 jusqu'à 300CC   X7   X8   X9   VESPA GTS | blanc |
| <b>489962</b> | 400   500 METROPOLIS                         | blanc |
| <b>489969</b> | T-MAX 500   530 +13%                         | blanc |
| <b>489960</b> | 125 PCX                                      | jaune |
| <b>489958</b> | 125 SH   PS   AGILITY                        | jaune |
| <b>489966</b> | MP3 jusqu'à 300CC   X7   X8   X9             | jaune |
| <b>489963</b> | 400   500 METROPOLIS                         | jaune |
| <b>489970</b> | T-MAX 500   530 +7%                          | jaune |
| <b>473372</b> | 125 MAJESTY   SKYLIN                         | jaune |
| <b>489961</b> | 125 PCX                                      | rouge |
| <b>489959</b> | 125 SH   PS   AGILITY   DINK STREET          | rouge |
| <b>489967</b> | MP3 jusqu'à 300CC   X7   X8   X9             | rouge |
| <b>489964</b> | 400   500 METROPOLIS                         | rouge |
| <b>489971</b> | T-MAX 500   530 +30%                         | rouge |
| <b>489972</b> | T-MAX 500   530 -39%                         | vert  |



479803



489969



489970



489971



489972

## VARIATION



## VARIATEUR

|        |   |
|--------|---|
| 492424 | 125 HONDA FORZA   SHI 2013->                      |
| 492425 | 125 HONDA PCX   SH 125                            |
| 492426 | 125 HONDA SHI 2013->                              |
| 492427 | 125 KYMCO 125 DOWNTOWN   DINKSTREET               |
| 475649 | 125 MAJESTY   SKYLINER                            |
| 490827 | 125 PEUGEOT CITYSTAR   DJANGO   TWEET             |
| 492448 | 125 PEUGEOT SATELIS   JET FORCE   GEOPOLIS        |
| 496330 | 125 PIAGGIO MEDLEY                                |
| 475642 | 125 PIAGGIO X9   X8   X EVO   MP3                 |
| 495157 | 125 SYM JOYMAX 2015->                             |
| 488731 | 125 TRICITY   TRYPTIK                             |
| 485916 | 125 VESPA 4 temps 3 soupapes                      |
| 475653 | 125 X-MAX   SKYCRUISER   EVOLIS                   |
| 495153 | 125 YAMAHA   MBK N-MAX   OCITO                    |
| 481480 | 400   500 MP3   X8   X EVO   X9 HI-SPEED          |
| 487349 | 400 KYMCO XCITING                                 |
| 487065 | 400 PEUGEOT METROPOLIS                            |
| 494555 | 400 X-MAX   |
| 475641 | 500 TMAX HI SPEED EVO 3 12 rouleaux               |
| 483493 | 530 TMAX HI SPEED EVOLUTION 2012                  |
| 481474 | 530 TMAX 2012 ->2017 HI-SPEED 8 rouleaux          |
| 494283 | 530 TMAX 2012->2017 HI SPEED EVO 8 courroies vert |
| 497315 | 530 TMAX HI SPEED 2017->                          |
| 497565 | 550 KYMCO   |
| 485917 | 600   650 BMW SPORT   GT                          |



## PIÈCES DÉTACHÉES VARIATEUR

|        |   |
|--------|---|
| 482862 | guide variateur METROPOLIS   X-CITING   T-MAX |
| 483494 | correcteur de couple TMAX 530                 |
| 477221 | ressort variateur EVO SLIDER T-MAX 500 +15%   |



482862



483494



477221

VARIATION



VARIATEUR

|        |                                     |
|--------|-------------------------------------|
| 483284 | 125 PIAGGIO X9   X8   MP3   TYPHOON |
| 483283 | 125 MAJESTY   SKYLINER              |
| 485620 | 125 PIAGGIO   VESPA LIBERTY   LX4   |
| 468857 | 125 4 temps CHINOIS   152QMI        |
| 489510 | 125   150 HONDA SH                  |
| 483287 | 125   150 KYMCO AGILITY             |
| 489509 | 125   150 SUZUKI BURGMAN UH K7 02-0 |



VARIATEUR

|        |                                |
|--------|--------------------------------|
| 480933 | 125 XMAX   SKYCRUISER   EVOLIS |
|--------|--------------------------------|



JOINT FIXE

|        |                                    |
|--------|------------------------------------|
| 488787 | 530 T-MAX pour origine ou multivar |
|--------|------------------------------------|



JOINT FIXE VENTILÉE

|        |                                    |
|--------|------------------------------------|
| 489511 | 125 PIAGGIO                        |
| 489514 | 125 MAJESTY   X-MAX                |
| 489513 | 125   150 KYMCO AGILITY            |
| 468859 | 125 SCOOTER CHINOIS 152QMI 4 temps |
| 489512 | 125   150 HONDA SH                 |



## EMBRAYAGE



## EMBRAYAGE DELTA CLUTCH

|               |                                  |
|---------------|----------------------------------|
| <b>461358</b> | 125 X9   X8   GEOPOLIS   SATELIS |
| <b>467664</b> | 125 XMAX                         |
| Ressort       |                                  |
| <b>478246</b> | 125 X-MAX (x3)                   |
| <b>478042</b> | SKYLINER   MAJESTY 125           |



## EMBRAYAGE DELTA CLUTCH 2G

|               |                                |
|---------------|--------------------------------|
| <b>487577</b> | 400   500 METROPOLIS   SATELIS |
|---------------|--------------------------------|



## EMBRAYAGE

|               |   |
|---------------|---|
| <b>489505</b> | 125 MP3   LIBERTY   VESPA GTS   ET4   X7   X8   X9 2003-> |
| <b>484563</b> | 125 HONDA SH   KYMCO AGILITY   SYM   TWEET                |
| <b>489506</b> | 125 PIAGGIO complet                                       |
| <b>485718</b> | 125 SUZUKI BURGMAN 2002->2006                             |
| <b>485717</b> | 125 SUZUKI BURGMAN 2007->2012                             |
| <b>489504</b> | 125 MAJESTY 1998->2002                                    |
| <b>489507</b> | 125 AGILITY complet                                       |
| <b>489508</b> | 125   150 HONDA SH complet                                |
| <b>495045</b> | 125 XMAX   EVOLIS   SKYCRUISER                            |
| <b>495311</b> | 400 PIAGGIO MP3   BEVERLY EURO 3                          |
| <b>495312</b> | 500 PIAGGIO   GILERA X9   NEXUS   ATLAN                   |



EMBAYAGE



EMBAYAGE

|        |   |
|--------|---|
| 485719 | 125 XMAX   SKYCRUISER   EVOLIS type origine |
| 490522 | 125 HONDA PCX type origine                  |
| 490647 | 125 HONDA SH type origine                   |
| 490649 | 125 KYMCO DOWNTOWN type origine             |
| 490650 | 125 SYM SYMPHONY   PEUGEOT TWEET            |
| 490648 | 125 SUZUKI BURGMAN K7 type origine          |
| 482825 | 125 YAMAHA MINARELLI MAJESTY                |
| 482827 | 125 KYMCO DINK 4 temps type origine         |



EMBAYAGE

|        |                                      |
|--------|--------------------------------------|
| 482826 | 125 PIAGGIO   GILERA   VESPA 4 temps |
|--------|--------------------------------------|



DISQUE D'EMBAYAGE

|        |                          |
|--------|--------------------------|
| 483501 | T-MAX 500 jeu + ressorts |
| 483502 | T-MAX 530 jeu + ressorts |

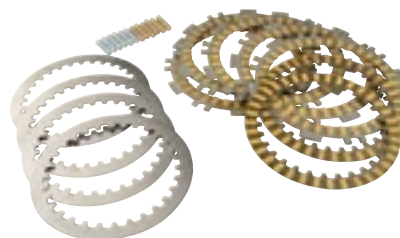

DISQUE D'EMBAYAGE

|        |              |
|--------|--------------|
| 485672 | 125 VESPA PX |
|--------|--------------|



TAMBOUR CLOCHE D'EMBAYAGE

|        |                              |
|--------|------------------------------|
| 482829 | PIAGGIO 125 4 temps          |
| 482828 | YAMAHA MINARELLI 125 4 temps |





## COURROIE



## COURROIE KEVLAR BELT

|        |  |                 |
|--------|--|-----------------|
| 477595 | 125 SUZUKI BURGMAN                     | 835x21.85       |
| 480735 | 125 DINK   GRAND DINK                  | 802x17.75       |
| 461357 | 125 PIAGGIO X9   X8   APRILIA ATLANTIC | 802x22.45       |
| 483454 | 125 SKYCRUISER   XMAX                  | 919x22.00       |
| 483456 | 500 TMAX 2004->2011                    | 892x30.8x28°    |
| 485496 | 600   650 BMW                          | 894x32x16.9x28° |



## COURROIE

|        |  |                   |
|--------|--|-------------------|
| 475647 | 125   150 VESPA moteur LEADER                      | 804x22.50         |
| 483492 | 530 TMAX KEVLAR pour variateur POLINI EVOLUTION    | 875x32.2x16x28°   |
| 475655 | 125 PIAGGIO LIBERTY ancien modèle                  | 845x17.5x8.5x30°  |
| 495827 | 125 YAMAHA NMAX   OCITO renfort aramide            | 951x26.2x10.5x28° |
| 495828 | 125 YAMAHA   MBK TRICITY   TRIPTIK renfort aramide | 867x22x10x28°     |



## COURROIE

|        |  |                    |
|--------|--|--------------------|
| 478097 | 125 X-MAX   SKYCRUISER                 | 919x24.60          |
| 489953 | 125 PIAGGIO X10 2013->                 | 937x22.5x10.2x30°  |
| 488407 | 125 PIAGGIO LIBERTY                    | 850x17.7           |
| 478095 | 125 PIAGGIO X7   X8   X9   MP3   VESPA | 800x22.35          |
| 478092 | 125 SUZUKI BURGMAN 2002->2006          | 847x21.60          |
| 478385 | 125 SUZUKI BURGMAN 2007->              | 847x21.92          |
| 489955 | 125 DINK STREET 2010->   PEOPLE        | 884x20.7x9.7x32°   |
| 461958 | 125 HEXAGON LX4 4 temps   SKIPPER      | 848x18.10          |
| 450218 | 125 MAJESTY   SKYLINER   MADISON       | 819x2175           |
| 490550 | 300 KAWASAKI J300   KYMCO DOWNTOWN     | 1004x25.2x14.7x30° |
| 478192 | 500 TMAX 2004->2011                    | 892x30.8x28°       |
| 481659 | 400   500 MP3   X EVO   X9   SATELIS   | 1009x27.30         |
| 489954 | 600   650 BMW C600   C650 GT 2012->    |                    |
| 496633 | 125 DAELIM S1   S2   OTELLO   FREEWING | 861x21.7           |
| 493615 | 125 FLAME X   CYGNUS X                 |                    |
| 496638 | 125 SUZUKI SIXTEEN 2008->              | 937x22.7           |
| 496639 | 125   150 KYMCO DINK   B&W             | 814x18.8           |
| 494758 | 250   300 X7   X8   XEVO PIAGGIO   MP3 |                    |
| 496644 | 300 SYM JOYMAX EVO                     | 932x25x34x15.5     |
| 496635 | 400 SUZUKI BURGMAN 2006->2009          | 1008x28            |
| 496636 | 400 YAMAHA MAJESTY YP   ABS 2004->2008 | 931x30             |
| 496642 | 400 KYMCO X-CITING i 2013->            | 984x28.5x28x15     |
| 496634 | 500 MP3 IE BUSINESS SPORT              |                    |
| 496641 | 500 KYMCO X-CITING 2004->              |                    |
| 496637 | 500 TMAX ->2003                        | 892x32x28x14       |
| 496640 | 800 GILERA GP   APRILIA 850 SRV        | 960x32.7x16.9      |



## COURROIE

**BANDO****COURROIE**

|        |  |                 |
|--------|--|-----------------|
| 461954 | 100 PEUGEOT ELYSEO   VIVACITY   X-FIGHT      | 782x17.90       |
| 485287 | 125 HONDA PCX                                | 816x22.1x30     |
| 490549 | 125 HONDA SH 2013->                          | 916x23x30       |
| 485367 | 125 HONDA SH   PANTHEON 4 temps              | 906x22.5x60     |
| 490551 | 125 SYM FIDDLE II 2010->                     | 818x19.5x28     |
| 485368 | 125 SYM GTS   VS                             | 800x19.5x30.9   |
| 490552 | 125 SYM JOYRIDE 2005->                       | 782x17.9x28     |
| 461955 | 125 FLAME   CYGNUS 4CW-17641-00              | 761x21.80       |
| 478102 | 125 KYMCO DINK   LEONARDO   SCARABEO         | 799x19x9x28°    |
| 478100 | 125 CHINOIS   152QMI   GY6   KYMCO HEROISM   | 743x20          |
| 480260 | 125 PEUGEOT   SYM TWEET   SYMPHONY   DINK    | 860x19.50x28°   |
| 478106 | 125 PEUGEOT SATELIS                          | 834x22.6X10X28  |
| 461953 | 125   150 PEUGEOT ELYSEO                     | 824x19.00       |
| 489952 | 530 T-MAX                                    | 875X32.2X16X28° |
| 496647 | 100 PEUGEOT TREKKER   SPEEDFIGHT   VIVACITY  | 799x18          |
| 496649 | 100 SYM MOI                                  | 714x18.5x28x8.5 |
| 494755 | 125 HONDA FORZA                              |                 |
| 496645 | 125 HONDA SH 2001->2010   PANTHEON 2003->    | 906x22.5        |
| 494756 | 125 KYMCO AGILITY R12   R16   PEOPLE         |                 |
| 494757 | 125 PEUGEOT LXR   SYM HD                     | 913X19.5X28     |
| 496646 | 125 PEUGEOT SATELIS KOMPRESSOR   ELYSEO      | 851x24.3x9.5x28 |
| 492929 | 125 PEUGEOT SUM UP   SCOOTER CHINOIS         | 835x20x30       |
| 496648 | 125 PEUGEOT VIVACITY                         | 826x19.5x9.5x30 |
| 497257 | 125 PIAGGIO X7   X8   X9   MP3   VESPA   ZIP |                 |
| 497258 | 125 SUZUKI BURGMAN 2007->                    |                 |
| 496653 | 125 SYM JOYRIDE ->2005                       | 819x19x9.5      |
| 497259 | 125 XMAX   SKYCRUISER                        |                 |
| 496651 | 125   150 SUZUKI AN                          | 759x19x30x8.5   |
| 496650 | 300 SYM GTS                                  | 907x24.40x10.5  |

**DAYCO****COURROIE**

|        |  |              |
|--------|--|--------------|
| 487726 | 125 XMAX   SKYCRUISER   EVOLIS                 | 919x22       |
| 487730 | 125   X7   X8   X9 PIAGGIO   MP3   VESPA   ZIP | 802x22.45    |
| 487728 | 125 SYM GTS   JOYRIDE   VS                     | 800x19x30.8  |
| 487729 | 125 MAJESTY   SKYLINER   MADISON               | 819x21.75    |
| 487731 | 400   500 PIAGGIO MP3   X EVO   X9             | 1002x21.40   |
| 487727 | 500 TMAX 2004-> renforcée kevlar               | 892x30.8x28° |



## COURROIE



## COURROIE

|        |   |              |
|--------|---|--------------|
| 486000 | 125 HONDA PCX                                   | 816x22.10x30 |
| 485669 | 125 FIDDLE   SYMPLY   ORBIT   DINK   GRAND DINK |              |
| 478433 | 125 YAMAHA MAJESTY   SKYLINER                   | 824x21.55    |
| 485999 | 125 PEUGEOT TWEET   SYM SYMPHONY                | 850x19.50x9  |
| 485670 | 125 SUZUKI BURGMAN 2002->2006                   | 814x21.6     |
| 468860 | 125 SCOOTER CHINOIS 152QMI 4 temps              | 743x20x30    |
| 492216 | 125 KYMCO AGILITY                               | 781x20x30    |
| 478432 | 125 PIAGGIO X7   X8   X9   X9 EVO   FLY         |              |
| 492215 | 125   150   200 SYM GTS                         | 819x19x30    |



## RÉSERVOIR



## BOUCHON ESSENCE

|        |                               |
|--------|-------------------------------|
| 479212 | SYLINER   MAJESTY avec 2 clés |
|--------|-------------------------------|



## ROBINET ESSENCE

|        |              |          |
|--------|--------------|----------|
| 485667 | 125 VESPA PX | M24X1.50 |
| 485666 | 125 VESPA PX | M24X1.50 |



485667



485666

RÉSERVOIR



ROBINET ESSENCE

|        |  |          |
|--------|--|----------|
| 484646 | HONDA SH125   DYLAN   CBR125 dépression              | M16x1.50 |
| 485668 | 125 MAJESTY   SKYLINER made in CEE                   |          |
| 490631 | 125 LIBERTY   VESPA   V-CLIC                         |          |
| 496621 | PEUGEOT 125 ELYSEO made in CEE                       |          |
| 496627 | APRILIA RS50 06 DERBI GPR 125 2004->2008 made in CEE |          |



POMPE À ESSENCE

|        |                                      |
|--------|--------------------------------------|
| 490630 | 125 VESPA   PIAGGIO GTV   X9   X8    |
| 487820 | 125 HONDA PCX                        |
| 484562 | 125   500   530   TMAX   X-MAX   MP3 |
| 484647 | 125 PIAGGIO X9                       |
| 484648 | 125 MAJESTY   SKYLINER               |
| 495695 | 125   150 HONDA SH   300 FORZA       |
| 491120 | 125   150   300 HONDA SH -->2010     |



POMPE À ESSENCE

|        |             |
|--------|-------------|
| 493878 | 500 PIAGGIO |
|--------|-------------|



AMORTISSEUR



AMORTISSEUR OLÉOPNEUMATIQUE BLEU (X1)

|        |                  |           |
|--------|------------------|-----------|
| 468762 | PIAGGIO   GILERA | 125   180 |
| 460931 | RUNNER -->2005   | 125   180 |



## AMORTISSEUR



### AMORTISSEUR RESSORT (X1)

|        |   | Entraxe |
|--------|---|---------|
| 493055 | HONDA 125 PCX 2010-2013                         | 312mm   |
| 482173 | HONDA 125 SH réglable dureté                    | 305mm   |
| 493060 | HONDA 125 SHI 2013->                            | 376mm   |
| 493057 | KYMCO 125   200   300 DOWNTOWN i 2009->2011     | 390mm   |
| 493056 | KYMCO 125   300 K-XCT   X-CITING 2012->2014     | 393mm   |
| 493053 | KYMCO 125 AGILITY R16 2009->2012                | 325mm   |
| 493063 | PIAGGIO 125   180   200   250 X9   X9 EVOLUTION | 340mm   |
| 493062 | PIAGGIO 125   200 X7   X8   XEVO                | 350mm   |
| 493059 | PIAGGIO 125 LIBERTY 2001-2012 EURO3             | 330mm   |
| 493054 | SUZUKI 125 BURGMAN 2007->2012                   | 340mm   |
| 493058 | VESPA 125 LX   LXV EURO3                        | 322mm   |
| 493064 | YAMAHA 125   250 XMAX 2010->2014                | 345mm   |
| 490409 | YAMAHA 125   250 XMAX->2009                     | 343mm   |
| 482172 | YAMAHA 125 MAJESTY noir réglable dureté         | 335mm   |



493055



482173



493060



493057



493056



493053



493063



493062



493059



493054



493058



493064



490409



482172

## DIRECTION



### JEU DE DIRECTION

|        |  |
|--------|--|
| 479325 | X MAX 125   SKYCUISER 125 ->2009 4 temps     |
| 486075 | X MAX 125   SKYCUISER 125 2010->2011 4 temps |
| 483328 | HONDA SH125   DYLAN 4 temps                  |
| 477260 | KYMCO AGILITY 50   125 4 temps               |
| 483058 | FLAME X   CYGNUS 125 4 temps                 |
| 483329 | MAJESTY   SKYLINER 125 4 temps               |

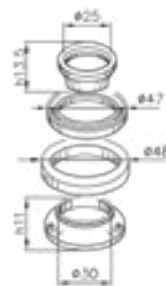

479325

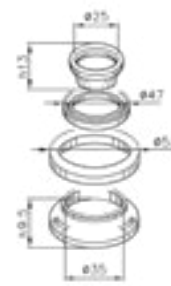

486075



483328

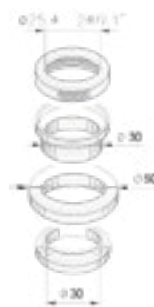

477260

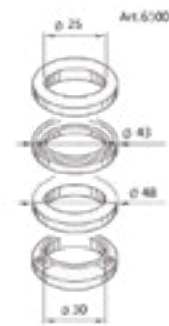

483058

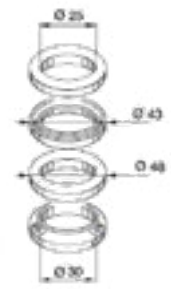

483329

DIRECTION



JEU DE DIRECTION

|        |  |
|--------|--|
| 491448 | 50   125 SYM FIDDLE 2   SYMPHONY   PEUGEOT |
| 491445 | KYMCO 125   300 DOWNTOWN   HONDA 300 SH    |
| 491446 | YAMAHA 500 T-MAX 2001->2007                |
| 491447 | YAMAHA 500   530 T-MAX 2008->              |

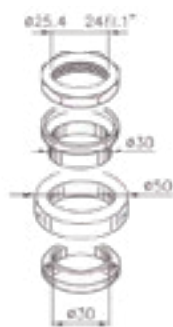

491448

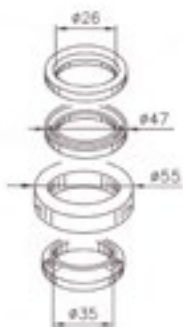

491445

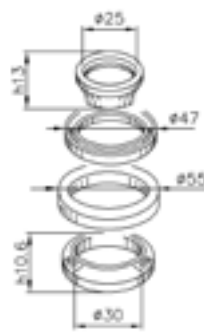

491446

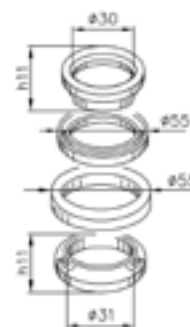

491447

JOINT



JOINT SPI FOURCHE (X2)

|        |   |                 |
|--------|---|-----------------|
| 480603 | XMAX 125->2009                            | 36x48x10        |
| 480625 | XMAX 125 2010->                           | 35x48x18        |
| 486026 | PCX   VITALITY                            | 31x43x10.3      |
| 486027 | BURGMAN 125 2007->2013   X MAX 2010->2012 | 32x45x8/10      |
| 480599 | LIBERTY   BURGMAN                         | 30x40x8/9       |
| 480609 | MAJESTY   ELYSTAR 125 2002->              | 33x45x10        |
| 480602 | AGILITY 125   DINK 4 temps   CYGNUS       |                 |
| 480601 | MAJESTY 125->2001   TZR 125->1993         | 33x45x11        |
| 480608 | XP6                                       | 36x48x11        |
| 480620 | TMAX 500 2004->2007                       | 41x53x11        |
| 486028 | TMAX 500   530 2008->                     | 43x55.1x9.5/10  |
| 486025 | BMW C600   650   X9 500                   | 40x52.2x10/10.5 |
| 493908 | 125 HONDA SH 2001->2012   PS 06           |                 |
| 493906 | 125 SR MAX   RUNNER   X7   X8             |                 |
| 493903 | 50   125 APRILIA RS4                      | 40x52x10        |
| 493905 | RX ->2004   RS50 99   PUCH MARZOCCHI      |                 |
| 493902 | XR6   HM FURIA   SENDA SM   R 2000->2001  |                 |
| 493907 | TYPHOON 2011->   FLY 4 temps 2005->2010   |                 |



## FOURCHE

## TE DE FOURCHE

**479323** AGILITY KYMCO 12" 50 | 125 (Ø30)



## BÉQUILLE

## BÉQUILLE

## Centrale

**483440** SKYCRUISER 125 | X MAX 125 noir

**483443** VESPA et 2 | ET4 | LX125 noir

**485716** KYMCO 125 GRAND DINK

**485714** HONDA 125 SH

**485715** PIAGGIO 125 | 150 PX (1761606)

**483446** LIBERTY | 125 | 200 noir

## Latérale

**482665** OCEO MBK 125 | CENTER YAMAHA 125 noir

**461568** LIBERTY 125-150-200 noir

**487377** 125 LIBERTY 4 temps 2014->



483440



483443



485716



485714



485715



483446



482665



461568



487377

**TUN'R** KIT DE CARROSSERIE



**479287**

AGILITY 125 MMC blanc (6 pièces) selle 2 parties



**479288**

AGILITY 125 MMC noir (6 pièces) selle 2 parties



**487619**

PCX 125 blanc (8 pièces)



**487618**

PCX 125 noir (8 pièces)



**487620**

T-MAX 500 2008->2011 noir (9 pièces)



**480107**

X-MAX 125 | 250 | SKYCRUISER->2010 noir (11 pièces)



ÉCLAIRAGE



CABOCHON DE CLIGNOTANT

- 480429 X-MAX 125 transparent arrière\*
- 480428 feu arrière MAJESTY | SKYLINER 125



480429



480428



FEU ARRIÈRE

- 493076 YAMAHA 530 T-MAX | YZF R1 2007->2008 fumé LEDs



CENTRALE CLIGNOTANT

- 486290 X-MAX | SKYCRUISER | EVOLIS 125
- 486289 SKYLINER | MAJESTY 125
- 486291 125 | 400 X EVO | MP3 | X8 | X9
- 486286 BURGMAN 125 | T-MAX 500 | 530



486290



486291



486286



486289

COMPTEUR



TRANSMISSION | CÂBLE COMPTEUR



479806

VESPA ET2 | ET4



490671

125 HONDA SH



490681

125 PIAGGIO LIBERTY 2007->



490679

125 PIAGGIO X7



490680

125 PIAGGIO X8



490678

125 SUZUKI BURGMAN  
2007->2011



490677

125 SUZUKI BURGMAN  
2002->2006



490676

125 SYM HD EVO



490675

125 SYM JOYRIDE



490683

125 KYMCO DINK 1997->



490684

125 KYMCO GRAND DINK  
2001->2004



490685

125 KYMCO AGILITY



482393

KYMCO AGILITY 50 | 125



490674

125 MAJESTY | SKYLINER



490682

125 VESPA GT | GTS 2003->



490686

50 | 125 VESPA | LX



490673

125 YAMAHA CYGN

## COMPTEUR



### TRANSMISSION | CÂBLE FREIN ARRIÈRE

490702 125 YAMAHA | MBK



### TRANSMISSION DE CÂBLE GAZ

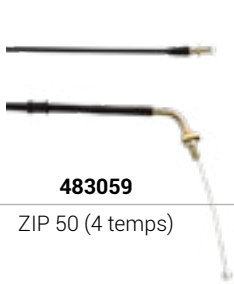

483059

ZIP 50 (4 temps)



482394

KYMCO AGILITY 50 | 125



490697

PIAGGIO 125 X9 (CM065911)



490699

HONDA 125 PANTHEON 2 temps



490698

HONDA 125 SH



490700

KYMCO 125 DINK



490701

125 YAMAHA | MBK MAJESTY | SKYLINER

## CONTACTEUR, ALARME



### CONTACTEUR À CLÉ



480784

PIAGGIO 125 X8 | X9



480415

ZIP 50 | FLY | VESPA | NRG (partie arrière)



484781

HONDA 125 PCX



490638

125 HONDA PANTHEON 2 temps



490634

125 HONDA SH 2001 -> 2004



490635

125 HONDA SHI 2008



484780

125 BURGMAN (avec serrure+réservoir)



490639

125 KYMCO AGILITY R16 2008->2012



490665

125 KYMCO DINK 4 temps -> 2007

CONTACTEUR, ALARME



CONTACTEUR À CLÉ



490664

125 KYMCO DOWNTOWN 2009 ->



486121

KYMCO DINK 50 | 125 1998->2007 (3 pièces)



490637

125 FLIPPER | WHY



490633

125 SCARABEO



490632

125 VESPA ET3 | PX



490004

MAJESTY | SKYLINER 2000->  
(sans plot faisceau)



477419

MAJESTY | SKYLINER 2000->



490636

125 | 300 | 400 | 500 PIAGGIO (partie arrière)

POIGNÉE, LEVIER



LEVIER DE FREIN



477437

YAMAHA | MBK 125 XMAX |  
SKYCRUISER 2006->

gauche



477446

YAMAHA | MBK 125 XMAX |  
SKYCRUISER 2006->

droit



485312

HONDA 125 PCX 2008->

gauche



485311

HONDA 125 PCX 2008->

droit



490689

HONDA 125 SHI 2009->

gauche



490690

HONDA 125 SHI 2009->

droit



477448

SUZUKI 125 BURGMAN 2002->

gauche



477436























SUZUKI 125 BURGMAN 2002->

droit

## POIGNÉE, LEVIER



## LEVIER DE FREIN

|   |   |  |   |
|---|---|--|---|
|    |        |    |      |
| <b>486995</b><br>SYM 125 GTS   JOYMAX<br>gauche                                     | <b>486994</b><br>SYM 125 GTS   JOYMAX<br>droit  | <b>490695</b><br>KYMCO 125 DINK 2007->  <br>AGILITY 50 R16 2009-><br>gauche          | <b>490696</b><br>KYMCO 125 DINK 2007-><br>droit   |
|    |        |    |      |
| <b>490691</b><br>KYMCO 125 DOWNTOWN<br>2009-><br>gauche                             | <b>490692</b><br>KYMCO 125 DOWNTOWN<br>2009-><br>droit                                  | <b>490693</b><br>KYMCO 125 GRAND DINK<br>2001->2007   DINK->2006<br>gauche           | <b>490694</b><br>KYMCO 125 GRAND DINK<br>2001->2007   DINK->2006<br>droit               |
|    |        |    |      |
| <b>477449</b><br>AGILITY 50   125(2005   2007)<br>VITALITY 2004->2007<br>gauche     | <b>477450</b><br>AGILITY 50   125 VITALITY<br>(2004   2007)<br>droit                    | <b>485698</b><br>PIAGGIO 125   400 MP3  <br>YAMAHA 125 MAJESTY<br>gauche             | <b>482743</b><br>SENDA DRD PRO 125   GPR<br>2010->   BETA RR   RS4  <br>SHERCO<br>droit |
|  |      |  |    |
| <b>485694</b><br>YAMAHA 500 T-MAX<br>2001->2008<br>gauche                           | <b>485695</b><br>YAMAHA 500 T-MAX<br>2001->2007<br>droit                                | <b>485697</b><br>YAMAHA 500   530<br>T-MAX 2008-><br>gauche                          | <b>485696</b><br>YAMAHA 500   530<br>T-MAX 2008-><br>droit                              |
|  |      |  |    |
| <b>490688</b><br>BMW C600   C650<br>gauche  | <b>490687</b><br>BMW C600   C650<br>droit   | <b>486993</b><br>125 VESPA GTS<br>droit ou gauche                                    | <b>485699</b><br>PIAGGIO 125   400 MP3   SR50<br>FACTORY D   G 2010-><br>droit          |
|  |      |  |   |
| <b>485700</b><br>125 MAJESTY   SKYLINER<br>1998->2007<br>droit ou gauche            | <b>477447</b><br>X8   X9   MP3   MAJESTY  <br>SKYLINER (1998   2007)<br>droit ou gauche |  |   |

POIGNÉE, LEVIER



LEVIER DE FREIN

|        |  |    |
|--------|--|----|
| 477418 | MAJESTY   SKYLINER HI TECH alu   gris droit  | x1 |
| 477417 | MAJESTY   SKYLINER HI TECH alu   gris gauche | x1 |
| 451639 | ELYSEO 125   PREDATOR 50                     | x2 |



477418



477417



451639



POIGNÉE DE FREIN

|        |                        |
|--------|------------------------|
| 485555 | 125 MAJESTY   SKYLINER |
|--------|------------------------|



POIGNÉE DE GAZ

|        |   |
|--------|---|
| 485554 | 125 PIAGGIO X7   X8   X9   EVO   MP3 2007->   VESPA |
|--------|---|



POIGNÉE DE GAZ

|        |                               |
|--------|-------------------------------|
| 485723 | PIAGGIO 250   300   400   500 |
|--------|-------------------------------|



COMODO | COMMUNICATEUR

|        |                              |        |
|--------|------------------------------|--------|
| 485550 | 125 MAJEST   SKYLINER        | gauche |
| 485551 | 125 MAJESTY   SKYLINER->2000 | droit  |



485550



485551

## TEKNIX RÉTROVISEUR



**493073**

KYMCO 125 | 300 DOWNTOWN i  
2009-> homologué CE  
droit



**493072**

KYMCO 125 | 300 DOWNTOWN i  
2009-> homologué CE  
gauche



**484957**

X-MAX | SKYCRUISER  
homologué CE 2009->  
droit



**484956**

X-MAX | SKYCRUISER  
homologué CE 2009->  
gauche



**477507**

X-MAX | SKYCRUISER  
homologué CE 2007->2008  
droit



**477506**

X-MAX | SKYCRUISER  
homologué CE 2007->2008  
gauche



**477509**

SKYLINER | MAJESTY  
homologué CE  
droit



**477508**

SKYLINER | MAJESTY  
homologué CE  
gauche



**486122**

HONDA 125 SH 2009-> | SFX50 |  
X8R homologué CE  
droit



**486123**

HONDA 125 SH 2009-> | SFX50 |  
X8R homologué CE  
gauche



**477511**

BURGMAN 125 homologué CE  
droit



**477510**

BURGMAN 125 homologué CE  
gauche



**482364**

DINK 50 | 125-SUPER DINK  
homologué CE  
droit



**482363**

DINK 50 | 125-SUPER DINK  
homologué CE  
gauche



**482366**

LIBERTY 50 | 125- LX 50 | 125  
chrome homologué CE  
droit



**482365**

LIBERTY 50 | 125- LX 50 | 125  
chrome homologué CE  
gauche



**486100**

T-MAX 500 2008->2011  
homologué CE  
droit



**486098**

T-MAX 500 2008->2011  
homologué CE  
gauche



**486103**

T-MAX 530 2012-> homologué  
CE  
droit



**486102**

T-MAX 530 2012-> homologué  
CE  
gauche

**Vespa** RÉTROVISEUR



**455270**

ELYSTAR 100 | 125 | 150-  
droit



**455290**

ELYSTAR 100 | 125 | 150  
gauche



**485701**

HONDA 125 PCX homologué CE  
droit



**485702**

HONDA 125 PCX homologué CE  
gauche



**455267**

ELYSEO 125 homologué CE  
droit



**455283**

ELYSEO 125 homologué CE  
gauche



**485703**

PEUGEOT 125 TWEET  
homologué CE  
droit



**485704**

PEUGEOT 125 TWEET  
homologué CE  
gauche



**481224**

VESPA LX 125 | PIAGGIO  
LIBERTY 125 homologué CE  
droit



**481225**

VESPA LX 125 | PIAGGIO  
LIBERTY 50 | 125 chromé  
homologué CE  
gauche



**482186**

APRILIA HABANA | MOJITO 50  
droit



**482238**

PIAGGIO LIBERTY 50 | 125  
gauche



**485705**

SYM 125 FIDDLE II homologué  
CE  
droit



**485706**

SYM 125 FIDDLE II homologué  
CE  
gauche



**467913**

PIAGGIO X8 125 | 200 et X8  
250i.e. homologué CE  
droit



**467912**

PIAGGIO X8 125 | 200 et X8 250  
i.e. homologué CE  
gauche



**455262**

RS 125 | 250 1997->2010  
homologué CE  
droit



**455282**

RS 125 | 250 1997->2010  
homologué CE  
gauche



**484857**

PIAGGIO MP3 125 | 250 | 400  
homologué CE  
droit



**480433**

PIAGGIO MP3 125 | 250 | 400  
homologué CE  
gauche



## Vicma<sup>MAXI</sup> RÉTROVISEUR



**440811**

PIAGGIO X9 125 | 150 | 250 | 500  
homologué CE  
droit



**440810**

PIAGGIO X9 125 | 150 | 250 | 500  
homologué CE  
gauche



**467911**

SATELIS 125 | 250 | 500  
homologué CE  
droit



**467910**

SATELIS 125 | 250 | 500  
homologué CE  
gauche



**479864**

APRILIA LEONARDO 125 | 150 |  
250 | 300  
gauche



**476770**

SCARABEO 125 homologué CE  
gauche

## MARCHE-PIEDS



### MARCHE-PIEDS

**468249** T MAX alu argent (2 pièces)



## SELLE



### SELLE CONFORT

**478333** 500 T MAX 2008->



# CONDITIONS GÉNÉRALES DE VENTE



## ARTICLE 1 - APPLICATION ET OPPOSABILITÉ DES CONDITIONS GÉNÉRALES DE VENTE

Les présentes conditions générales de vente s'appliquent systématiquement aux commandes passées avec la société C.G.N. sauf dérogation formelle et exprime de notre part, étant précisées que lesdites conditions remplacent et annulent toutes les autres conditions précédemment diffusées et ce quel que soit le support utilisé. Le fait de passer commande implique l'adhésion entière et sans réserve de l'acheteur à ces conditions générales de vente.

## ARTICLE 2 - CONDITIONS DE DISTRIBUTION DE NOS PRODUITS

Afin de mieux organiser la distribution de ses produits et soucieuse de réserver au consommateur final un service de qualité et le respect des normes de sécurité, la société C.G.N. distribue ses produits de façon sélective. Tout nouveau client devra donc pour obtenir l'ouverture d'un compte :

- Être une entité dûment enregistrée au Registre du commerce et des Sociétés ou au Répertoire des Métiers ; utilisant un équipement adéquat pour la vente et la maintenance des cycles, cyclomoteurs, scooter, motos et tricycles et quadricycles à moteur dans des locaux fixes ouverts au public.
- S'engager à ne monter ou à ne revendre les pièces détachées vendues par nos soins, que pour leurs affectations, sans détournement d'usage.
- S'engager à ne pas modifier les pièces détachées vendues par nos soins, afin de changer les caractéristiques de ladite « pièce détachée ».

Tout compte sera clôturé automatiquement en l'absence de commande pendant une période de 6 mois consécutifs. Le client devra alors refaire une ouverture de compte pour passer commande.

## ARTICLE 3 - COMMANDES

Les commandes reçues ne sont valables qu'après acceptation expresse de la société C.G.N. L'acceptation de la marchandise par le client, matérialisée par la signature du bon du transporteur, fait foi de l'acceptation de la commande.

## ARTICLE 4 - PRIX

Nos prix sont ceux figurant au catalogue. Cependant, en raison des variations constantes du cours des matières premières, du cours des changes et des tarifications de transport, nos prix sont donnés sans engagement et peuvent être modifiés sans avis préalable. Les prix facturés sont ceux en vigueur le jour de la livraison.

- 1 - France métropolitaine

Nos prix s'entendent nets, au départ de Saint-Herblain, emballage compris. L'expédition des marchandises s'effectuera en franco de port à partir de 299,00 € H.T. Excepté du mardi 18h au mercredi minuit, à partir de 190 € H.T.

- 2 - Dom Tom / Export

Nos prix sont fixés départ usine.

## ARTICLE 5 - CONDITIONS DE RÈGLEMENT

- 1 - France métropolitaine

Nous nous réservons le droit de demander un règlement en contre remboursement pour les clients qui achèteraient moins de 299,00 Euros H.T. par mois de marchandises sur une année. Nous nous réservons le droit d'exiger le paiement comptant lors de l'entrée en relation avec un nouveau client ou ultérieurement si un client ne présente pas de garanties suffisantes. Pour tout nouveau client, les livraisons s'effectueront en contre remboursement ou après paiement, pendant une période d'une année minimum.

Dans les autres cas, le paiement est effectué soit au comptant par LCR avec un escompte de 0,5% par mois soit par LCR à 30 jours le 25. En cas de retard ou d'incident de paiement, nous nous réservons le droit d'expédier les livraisons suivantes uniquement après paiement de celles-ci et ce sans préavis. Les frais bancaires générés par le retour de LCR impayées seront facturés au débiteur défaillant. A défaut de règlement dans les délais fixés, l'acheteur sera de plein droit redevable d'un intérêt de retard égal à une fois et demie (1,5) le taux d'intérêt légal au jour de la facturation et ce à compter de la date d'échéance et sans mise en demeure. Lesdits intérêts se capitalisant automatiquement.

Tout retard de paiement entraînera, de plein droit, le règlement d'une indemnité forfaitaire pour frais de recouvrement d'un montant de 40€, et d'une indemnité complémentaire sur justification (Art. L 441-6, al.12 du Code de Commerce).

- 2 - Dom Tom / Export

Le paiement devra être réalisé avant l'expédition et après acceptation de la facture pro-forma ou par crédit documentaire irrévocable et confirmé si le chiffre d'affaires annuel avec la société C.G.N. est supérieur à 7 622 Euros H.T ou par traite sous réserve d'acceptation de la COFACE.

## ARTICLE 6 - FORCE MAJEURE

La survenance d'un cas de force majeure a pour effet de suspendre l'exécution des obligations contractuelles de la société C.G.N. Est un cas de force majeure tout événement indépendant de la volonté de la société C.G.N. et faisant obstacle à son fonctionnement normal. Constituent notamment des cas de force majeure les grèves totales ou partielles entravant la bonne marche de la société C.G.N. ou celle

de l'un de ses fournisseurs, sous-traitant ou transporteur ainsi que l'interruption des transports, de la fourniture de pièces.

## ARTICLE 7 - LIVRAISON

Aucune livraison ne sera effectuée pour toute commande inférieure à 76,00 Euros H.T., les clients devant alors se déplacer au comptoir. Nos délais de livraison sont indicatifs (France : 8 jours ; Dom Tom - Export : 3 semaines) et les retards ne pourront justifier une annulation de commande. Toutes nos marchandises voyagent aux risques et périls de l'acheteur, à qui il appartient en prenant possession des colis, de les vérifier en présence du livreur, et de formuler au besoin les réserves nécessaires. En cas d'avarie l'acheteur doit faire ses réserves par lettre recommandée avec avis de réception auprès du transporteur dans un délai de 48 heures. À défaut de réserves expressément émises par l'acquéreur lors de la livraison, les produits délivrés par la société

C.G.N. seront réputés conformes en quantité et qualité à la commande. Les délais de livraison sont donnés par CGN à titre indicatif. En conséquence, les retards éventuels n'autorisent pas le client à annuler la vente, refuser la marchandise ou réclamer des dommages et intérêts ou de quelconque pénalité de retard. Toutes réclamations portant sur les produits livrés, exception faite de celles relatives au transport, doivent être formulées par écrit dans les huit jours ouvrés de la réception des produits chez le client. Aucun produit ne pourra être retourné sans l'accord préalable et écrit de CGN.

## ARTICLE 8 - GARANTIES

La société C.G.N. garantit ses produits contre tout défaut de matière ou vice de fabrication sous réserve des durées et conditions d'acceptation des constructeurs, sans pouvoir être considéré par l'acquéreur comme responsable des éventuelles conséquences dommageables que ces vices cachés auraient pu entraîner. Le mauvais montage ou le non-respect de l'entretien de nos produits (chocs...) entraînent l'annulation de la garantie. Aucune garantie n'est acceptée sur du matériel utilisé sauf concernant défauts relevant de la garantie des vices cachés. Seule la partie de la pièce jugée défectueuse sera échangée. L'engagement de la société C.G.N. ne s'effectue qu'après acceptation de la garantie du fournisseur et dans un délai de 3 mois à compter de la livraison. La prise de possession de nos articles emporte implicitement l'acceptation de nos conditions.

## ARTICLE 9 - RETOUR DE MARCHANDISES

Aucun échange de marchandises ne sera accepté, sauf erreur de notre part. Tout retour de marchandises nécessite l'accord préalable de la société C.G.N.. Tout colis devra être retourné en port payé. Les retours de pièces non conformes à la commande doivent être accompagnés du numéro et de la date de la facture dans un délai maximum de 3 mois et dans leur emballage d'origine. Si l'erreur incombe à la société C.G.N., les frais de port seront remboursés. Tout retour de marchandise dû à une erreur de commande imputable à l'acheteur fera l'objet d'un avoir correspondant auquel sera appliqué un abattement de 20%.

## ARTICLE 10 - RÉSERVE DE PROPRIÉTÉ

Il est convenu entre les parties, que le transfert de propriété des marchandises faisant l'objet du présent bon de commande, ne sera effectué qu'au moment du paiement intégral du prix de ces marchandises, en principal et accessoire, et jusqu'à l'apurement du compte de l'acheteur dans nos livres. Ces dispositions ne font pas obstacle au transfert à l'acheteur, dès la livraison, des risques de perte et de détérioration des biens vendus ainsi que des dommages qu'ils peuvent occasionner. L'acheteur devra souscrire une assurance pour les risques nés à partir de la délivrance de la marchandise. Le droit de reprise sera exercé par la société C.G.N. en cas de retard de paiement. Il est précisé que ne constitue pas un paiement, la remise de traite ou autres titres créant une obligation de payer. Si la société C.G.N. est amenée à exercer son droit de revendication et à reprendre ses marchandises, la vente est résolue de plein droit. La société C.G.N. pourra alors revendre lesdites marchandises dans le cadre de l'exploitation normale de son entreprise. L'acheteur s'engage à informer ses clients de la clause de réserve de propriété pesant sur les marchandises et du droit que nous nous réservons de revendiquer entre leurs mains soit la marchandise litigieuse soit le prix en vertu des articles 115 et suivants de la loi n° 85-98 du 25 janvier 1985 modifiés par la loi du 10 juin 1994. En cas de saisies opérées par des tiers, sur les marchandises, objets du présent bon de commande, en fraude des droits du vendeur, l'acheteur est tenu d'en informer immédiatement la société C.G.N.

## ARTICLE 11 - LITIGES

Tout litige relatif à la présente vente, même en cas de recours en garantie ou de pluralité de défendeurs serait, à défaut d'accord amiable, de la compétence exclusive des juridictions judiciaires de Nantes.

## ARTICLE 12 - DROIT APPLICABLE

Toutes les clauses figurant dans les présentes conditions générales de vente, ainsi que toutes les opérations d'achat et de vente qui y sont visées, seront soumises au droit français.



# PLUS DE 80 MARQUES

DE PIÈCES DÉTACHÉES, D'ACCESSOIRES POUR LE SCOOTER ET LA MOTO AINSI QUE DE L'ÉQUIPEMENT DU PILOTE.



## DIMENSIONS ET GRAMMAGES DES GALETS D'ORIGINE SCOOTER SOCC

|                                   | Dimensions | Grammages |
|-----------------------------------|------------|-----------|
| <b>APRILIA</b>                    |            |           |
| RALLY (MINARELLI)                 | 15x12      | 6.5       |
| SR (PIAGGIO)                      | 19x15.5    | 7.5       |
| SR (MINARELLI)                    | 15x2       | 5.5       |
| <b>BENELLI</b>                    |            |           |
| 491 (MINARELLI)                   | 15x12      | 6.5       |
| 491 (MORINI)                      | 17x12.3    | 5.3       |
| CPI                               |            |           |
| ARAGON                            | 15x12      | 6         |
| HUSSAR                            | 15x12      | 6         |
| OLIVER                            | 15x12      | 6         |
| POPCORN                           | 15x12      | 6         |
| <b>DERBI</b>                      |            |           |
| ATLANTIC                          | 19x15.5    | 6.5       |
| ATLANTIC (MORINI)                 | 17x12.3    | 7         |
| GP1                               | 19x15.5    | 6.5       |
| <b>GILERA</b>                     |            |           |
| DNA                               | 19x15.5    | 7.5       |
| ICE                               | 19x15.5    | 7.5       |
| RUNNER PUR JET ->2005   SP 2006-> | 19x15.5    | 6.5       |
| RUNNER PUR JET 2006->             | 19x15.5    | 5.5       |
| RUNNER SP ->2005                  | 19x15.5    | 7.5       |
| STALKER                           | 19x15.5    | 7.5       |
| <b>HONDA</b>                      |            |           |
| BALI                              | 16x13      | 8.5       |
| DIO                               | 16x13      | 8.5       |
| SH 1996->                         | 16x13      | 9         |
| SHADOW                            | 16x13      | 8.5       |
| VISION                            | 16x13      | 8.5       |
| X8R                               | 16x13      | 8.5       |
| ZOOMER                            | 16x13      | 6         |
| <b>KEEWAY</b>                     |            |           |
| F-ACT   RY8                       | 15x12      | 6         |
| GOCCIA                            | 15x12      | 4.8       |
| HURRICANE                         | 15x12      | 4.8       |

|  | Dimensions | Grammages |
|--|------------|-----------|
| MATRIX                                   | 15x12      | 4.8       |
| PIXEL                                    | 15x12      | 4.8       |
| <b>KYMCO</b>                             |            |           |
| AGILITY R10/12/16 4 temps EURO2          | 16x13      | 6         |
| DINK 2 temps                             | 16x13      | 8.5       |
| DINK 4 temps                             | 16x13      | 6         |
| SUPER 8                                  | 16x13      | 6         |
| <b>MALAGUTI</b>                          |            |           |
| F12 (MINARELLI)                          | 15x2       | 6.5       |
| <b>MBK   YAMAHA</b>                      |            |           |
| BOOSTER   NG   ROCKET   STUNT (catalysé) | 15x12      | 5.4       |
| BOOSTER (non catalysé)                   | 15x12      | 6.5       |
| MACH G air (catalysé)                    | 15x12      | 6.5       |
| MACH G liquide                           | 15x12      | 5.4       |
| NITRO (catalysé)                         | 15x12      | 6.5       |
| NITRO liquide                            | 15x12      | 5.4       |
| OVETTO (catalysé)                        | 15x12      | 6.5       |
| OVETTO 4 temps                           | 15x12      | 4.8       |
| STUNT (non catalysé)                     | 15x12      | 6.5       |
| <b>PEUGEOT</b>                           |            |           |
| BUXY                                     | 16x13      | 8.5       |
| DJANGO 2 temps                           | 16x13      | 8.9       |
| DJANGO 4 temps                           | 16x13      | 5.6       |
| ELYSEO 2 temps                           | 16x13      | 9         |
| KISBEE 2 temps                           | 16x13      | 8.9       |
| KISBEE 4 temps                           | 16x13      | 5.6       |
| LUDIX 2 temps                            | 16x13      | 8.9       |
| LUDIX BLASTER 2 temps                    | 16x13      | 8         |
| LUDIX ONE                                | 16x13      | 9         |
| METAL X 2 temps                          | 16x13      | 9         |
| SPEEDAKE                                 | 16x13      | 8.5       |
| SPEEDFIGHT 1 et 3                        | 16x13      | 9         |
| SPEEDFIGHT 2, 2 temps                    | 16x13      | 8         |
| SPEEDFIGHT 3, 2 temps                    | 16x13      | 8.9       |
| SQUAB                                    | 16x13      | 9         |

|                         | Dimensions | Grammages |
|-------------------------|------------|-----------|
| SV                      | 16x13      | 8.5       |
| TREKER                  | 16x13      | 8.5       |
| TWEET                   | 16x13      | 6         |
| V CLIC                  | 16x13      | 5.6       |
| VIVACITY ->2008         | 16x13      | 8.5       |
| VIVACITY 2008-> 2 temps | 16x13      | 8         |
| VIVACITY 3 4 temps      | 16x13      | 6         |
| VIVACITY 3, 2 temps     | 16x13      | 8.9       |
| ZENITH                  | 16x13      | 8.5       |
| <b>PIAGGIO   VESPA</b>  |            |           |
| ET2 2000                | 19x15.5    | 7.5       |
| ET4                     | 19x15.5    | 6.5       |
| FLY 2 temps             | 19x15.5    | 7.5       |
| FLY 4 temps             | 19x15.5    | 6.5       |
| LIBERTY 2 et 4 temps    | 19x15.5    | 6.5       |
| MC3 PURJET DD EXTREME   | 19x15.5    | 7.5       |
| NRG                     | 16x13      | 8.5       |
| NRG MC2                 | 16x13      | 7         |
| NRG MC2 1999->          | 19x15.5    | 7.5       |
| NRG POWER DT 4 temps    | 19x15.5    | 6.5       |
| NRG POWER PUREJET       | 19x15.5    | 5.5       |
| TYPHOON ->1999          | 16x13      | 8.5       |
| TYPHOON 1999->2007      | 19x15.5    | 7.5       |
| TYPHOON 2007->          | 19x15.5    | 7.5       |
| ZIP 2001->              | 19x15.5    | 7.5       |
| ZIP 4 temps             | 19x15.5    | 6.5       |
| ZIP FAST RIDER          | 16x13      | 8.5       |
| ZIP SP liquide ->2000   | 16x13      | 7         |
| <b>SUZUKI</b>           |            |           |
| ADDRESS                 | 17x12.3    | 6.5       |
| KATANA                  | 17x12.3    | 6.5       |
| <b>SYM</b>              |            |           |
| DD                      | 16x13      | 8.5       |
| JET                     | 16x13      | 8.5       |
| MOI                     | 16x13      | 5.9       |
| SYMPHONY                | 16x13      | 5.9       |
| SYMPLY                  | 16x13      | 5.9       |

## DIMENSIONS ET GRAMMAGES DES GALETS D'ORIGINE MAXI SCOOTER

|                                   | Dimensions | Grammages |
|-----------------------------------|------------|-----------|
| <b>APRILIA   GILERA   PIAGGIO</b> |            |           |
| BEVERLY 125/200                   | 19x17      | 7.4       |
| DNA 125 4 temps                   | 19x17      | 10        |
| FLY 125 4 temps                   | 19x17      | 8.7       |
| HEXAGON                           | 19x17      | 12        |
| LEONARDO                          | 20x17      | 8.5       |
| LIBERTY ->1999                    | 19x13.7    | 12        |
| LIBERTY 125                       | 19x17      | 8.7       |
| MP3 125                           | 19x17      | 8.7       |
| SCARABEO                          | 19x17      | 7.4       |
| SCARABEO 125 (ROTAX)              | 20x17      | 8.5       |
| SKIPPER                           | 19x17      | 12        |
| SR 125                            | 19x17      | 12        |
| SUPER HEXAGON                     | 19x17      | 7.4       |
| TYPHOON 125 2 temps               | 19x17      | 8.7       |
| TYPHOON 4 temps                   | 19x17      | 12        |
| X7                                | 19x17      | 7.4       |
| X8                                | 19x17      | 7.4       |
| X9                                | 19x17      | 7.4       |
| ZIP 125                           | 19x17      | 8.7       |
| <b>HONDA</b>                      |            |           |
| DYLAN (injection)                 | 20x14.6    | 11.5      |
| DYLAN 150                         | 20x14.6    | 12.5      |
| PANTHEON                          | 20x14.6    | 12.3      |
| PANTHEON (injection)              | 20x14.6    | 11.5      |
| PANTHEON 150 2 temps              | 23x18      | 17        |
| PANTHEON 150 4 temps              | 20x14.6    | 12.5      |
| PCX 125                           | 20x14.6    | 14.5      |
| PS (injection)                    | 20x14.6    | 11.5      |

|                       | Dimensions | Grammages |
|-----------------------|------------|-----------|
| SH (injection)        | 20x14.6    | 11.5      |
| SH 125 (injection)    | 20x14.6    | 10.5      |
| <b>KYMCO</b>          |            |           |
| AGILITY 125           | 18x14      | 13        |
| AGILITY 125RS/150     | 20x14.6    | 15.5      |
| BET & WIN 125/150     | 20x14.6    | 15.5      |
| DINK 125              | 20x14.6    | 15.5      |
| GRAND DINK 125        | 20x14.5    | 12.5      |
| GRAND DINK 250        | 23x18      | 20        |
| PEOPLE 125            | 18x14      | 13        |
| PEOPLE 150/200        | 20x14.6    | 15.5      |
| PEOPLE 250            | 23x18      | 20        |
| SUPER 8 125           | 18x14      | 13        |
| <b>MALAGUTI</b>       |            |           |
| MADISON 125 (YAMAHA)  | 20x12      | 10        |
| <b>MBK   YAMAHA</b>   |            |           |
| CYGNUS 125 INJECTION  | 20x12      | 9         |
| GYGNUS 125            | 20x12      | 10        |
| MAJESTY 125           | 20x12      | 9         |
| T MAX 500 2001 ->2003 | 24x14.9    | 20        |
| T MAX 500 2003->      | 24x14.9    | 18        |
| T MAX 530             | 24x14.9    | 17        |
| X CITY 125            | 20x12      | 10        |
| X CITY 250            | 20x12      | 12        |
| X MAX 125             | 20x12      | 10        |
| X MAX 250             | 20x12      | 12        |
| <b>PEUGEOT</b>        |            |           |
| ELYSEO                | 20x12      | 12        |
| ELYSTAR               | 20x12      | 12.3      |

|                                   | Dimensions | Grammages |
|-----------------------------------|------------|-----------|
| GEOPOLIS 125                      | 20x17      | 9.5       |
| GEOPOLIS 250                      | 20.9x17    | 11        |
| GEOPOLIS 250                      | 20.9x17    | 11        |
| JET FORCE 125                     | 20x17      | 9.5       |
| JET FORCE 125 (COMPRESSORT)       | 20.9x17    | 11        |
| SATELIS 125                       | 20x17      | 9.5       |
| SATELIS 125 (COMPRESSORT)         | 20.9x17    | 11        |
| TWEET 125                         | 18x14      | 10        |
| <b>SUZUKI</b>                     |            |           |
| BRUGMAN 125                       | 20x15      | 12.9      |
| BRUGMAN 150                       | 20x15      | 16.8      |
| BRUGMAN 250                       | 23.8x18    | 23        |
| <b>SYM</b>                        |            |           |
| EURO MX 125                       | 18x14      | 10        |
| FIDDLE 125 EURO3                  | 18x14      | 14        |
| GTS 125                           | 18x14      | 10        |
| SYMPHONY 125                      | 18x14      | 10        |
| <b>VESPA</b>                      |            |           |
| ET4 125 (LEADER)                  | 19x13.7    | 12        |
| ET4 125 (LEADER)                  | 19x17      | 8.7       |
| ET4 125 (LEADER)                  | 19x17      | 10        |
| GRANTURISMO L GT 200              | 20x17      | 12.5      |
| GRANTURISMO L GT GTV 125 (LEADER) | 19x17      | 7.4       |
| GTS 125 (injection)               | 19x17      | 7.4       |
| LX 125 (LEADER)                   | 19x13.7    | 12        |
| LX 125 (LEADER)                   | 19x17      | 8.7       |
| LX 150 (LEADER)                   | 19x17      | 10        |



www.cgnfrance.com  
167, boulevard Salvador Allende  
44812 Saint Herblain Cedex - France  
Mail : contact@cgnfrance.com  
Tél. 02 40 92 00 95  
Fax. 02 40 92 04 88



www.cgnfrance.com



3 663829 110991